

Nähmaschinen-Ersatzteile

Sewingmachine Spare parts

Piezas de recambio para máquinas de coser

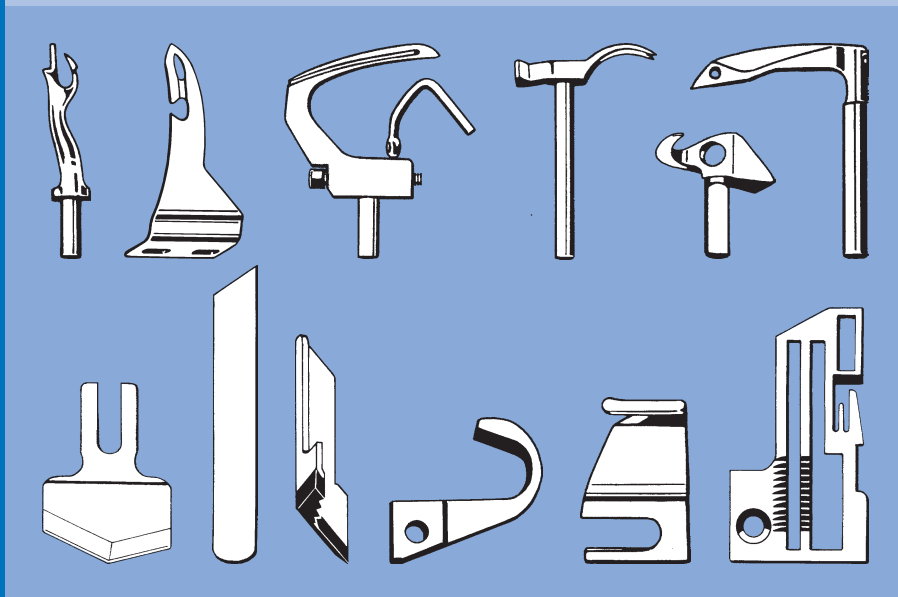
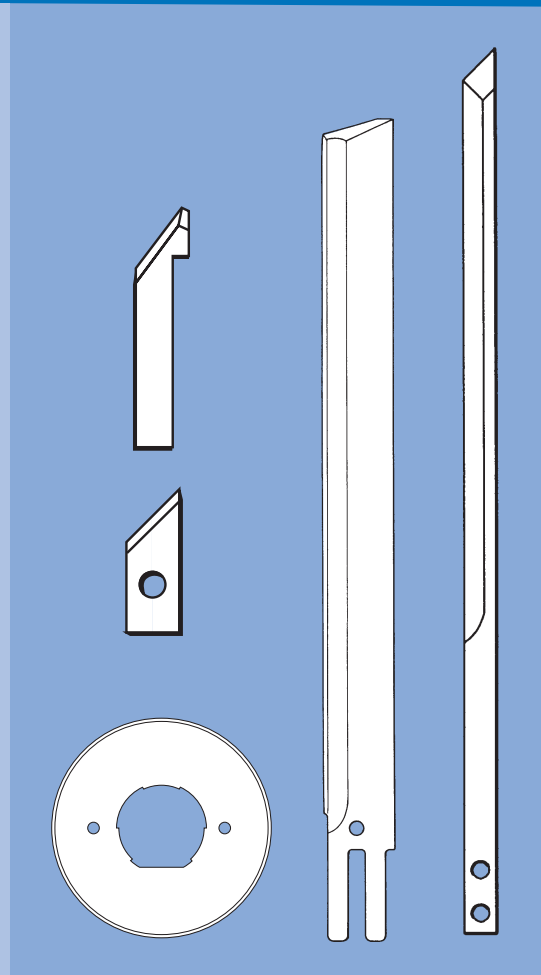

2017



8516



81077009 (CT)



81071606



81071614

Weitere Messer und Greifer für
Textima/Altin auf Anfrage.

Further knives and looper for
Textima/Altin on request.

Otras cuchillas y anclas para
Textima/Altin de ser demandadas.

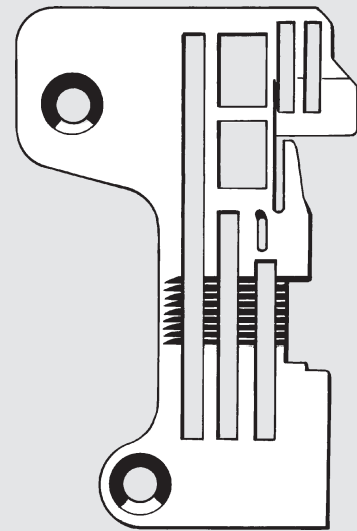

81073087

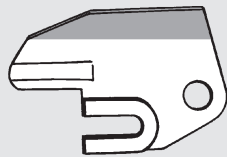

81074018 (CT)



81071415



81071401

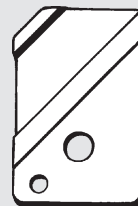

81071609

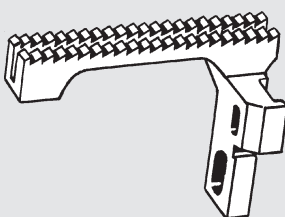

81073371

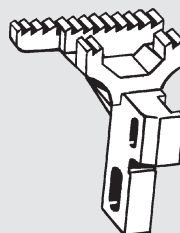

81073034

8515

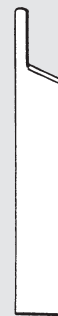

81001127
81000669
8509-7.10

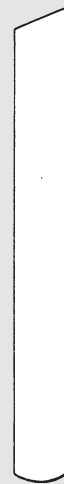

81001126
81000670
8509-8.3



LK3-B 430, B 433, B 434, B 441, BE 438C,
KE-430C-436C, KE 484C, KE 438D, KM-4300
KE 430D, BE 438D

BAS 310, 311, 326, 342
BAS 430, 433
BAS 300G, 311G, 326G, 342G

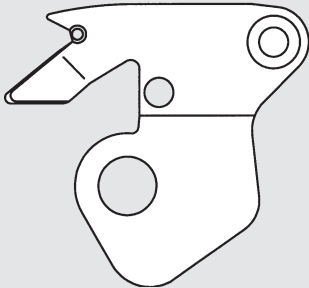

152901-001

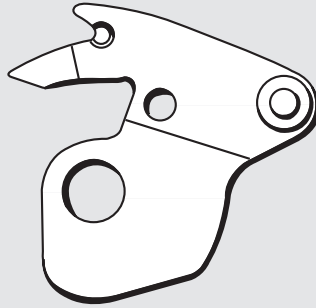

154176-001

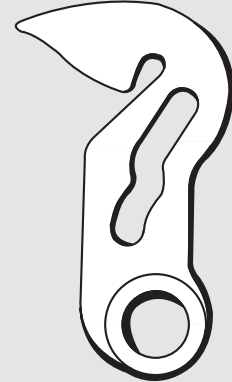

152906-001



S 49988-001



S 10205-001



SA 6596-001
SA 3330-001

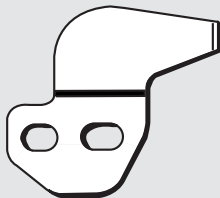

SA 3335-001

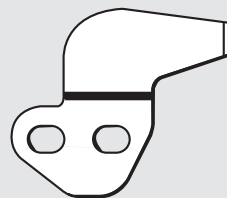

SA 6431-001

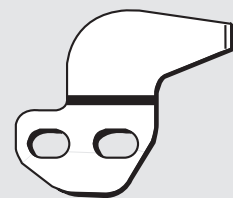

SA 7944-001

BAS 320, 322



S 10210-001
S 10210-201



152905-001



S 02375-001

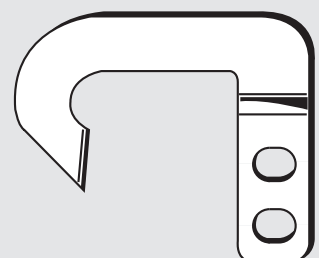

S 02374-001



B 484

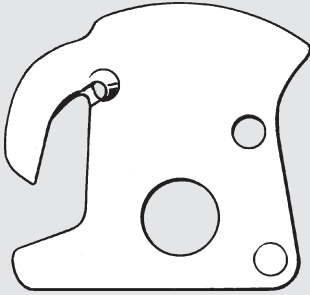

S 00706-201



S 00713-001

DB2-B 716



154568-001

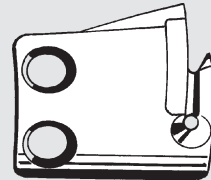

154575-001

BSC 7760



S 44134-001

**B 711, B 737, B 738, B 791, B 798
BAS 760**

**S 6200 A
S 7200 A**

**S 7200 B
S 7200 C**

**SL 7220 B
SL 737, SL 7200 A, SL 7200 B**



159540-001

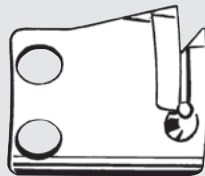

159915-001

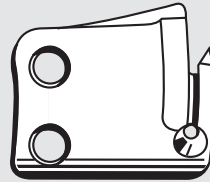

159799-001

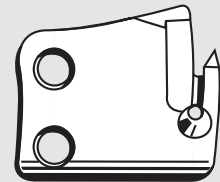

159541-001

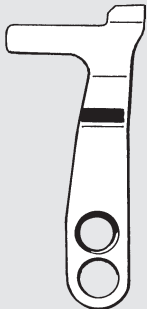

S 02637-001
S 02637-101



S 45900-101

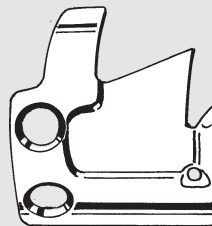

S 02645-001

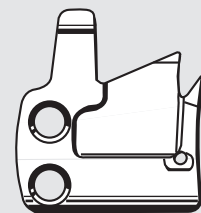

S 02646-001



**B 600, B 832, B 833, B 837
BAS 620**

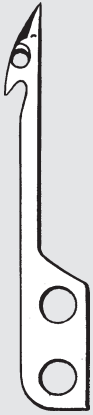

159365-001



153019-001



S 16248-101

DBZ-B 755

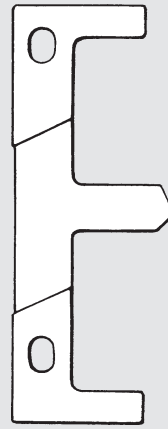

142061-001

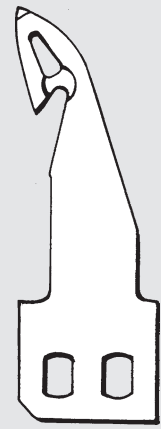

142058-001

**DB 2-B 772
BAS 423
SL 777 B**



S 32474-001

**SL 777 A, SL 778 A
SN 771 A, SN 772 A**



S 32477-001



S 10605-001



S 10605-201

DT 6-B 924, B 928

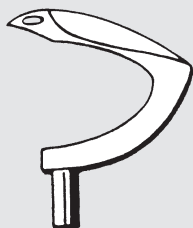

SY 0069084

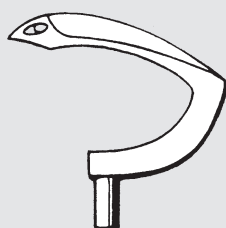

SY 0069085



SY 0069086

**B 931, B 932
JC-9330, JC-9331
JC-9380, JC-9381**



110121-001

LS 5-P 73/P 81



S 27634-001



B 912, B 913, B 915, B 917
BM-916 A, BM-917 A, BM-917 B, BM-917 C



S 03536-001

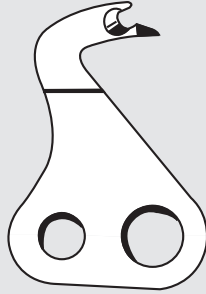

S 03627-001



S 03629-001

B 926-6A

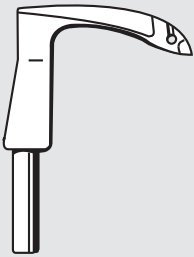

148869-001

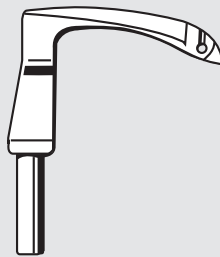

148870-001

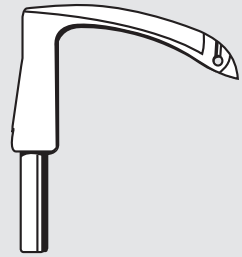

148871-001

B 928

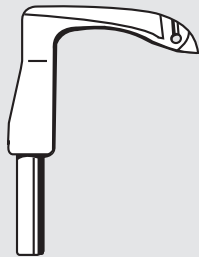

S 40375-001

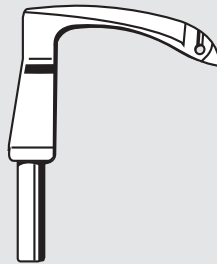

S 40376-001

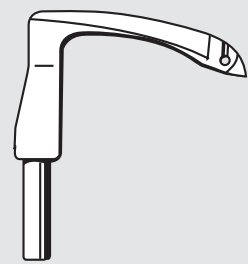

S 40377-001

Homelock

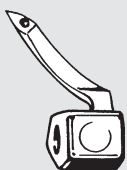

127814-001
Kl. 127

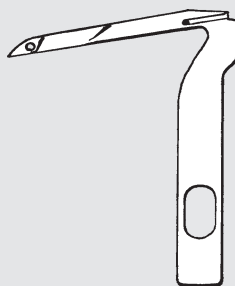

127815-001
Kl. 127

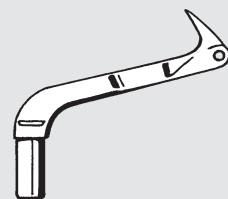

127260-001
Kl. 522



LT 2-B 842, LT 2-B 875
T-8422A, T-8452A, T-8722A, T-8752A
TN-842B

T-8422B, T-8452B
T-8722B, T-8752B

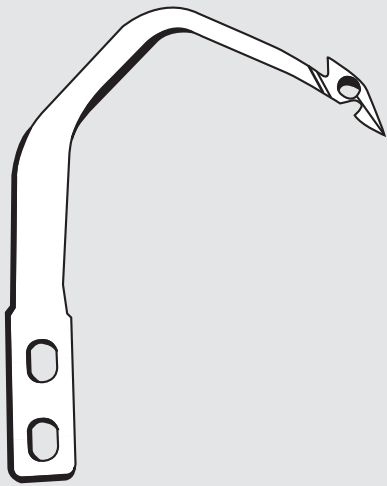

S 07526-001

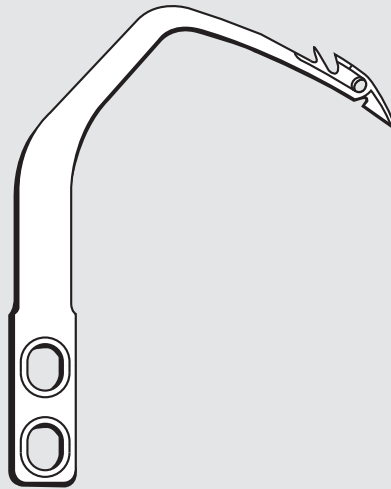

S 07526-201



S 07527-001

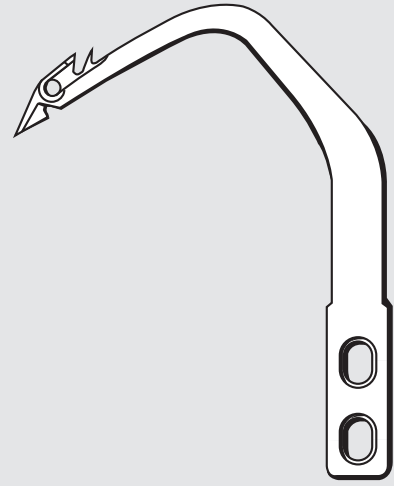

S 07526-301

FD4-B 270 Series
FD4-B 2700 Series

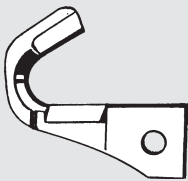

S 09094-001 (CT)

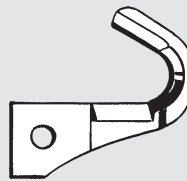

S 09093-001 (CT)

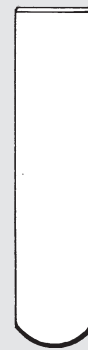

S 09101-001

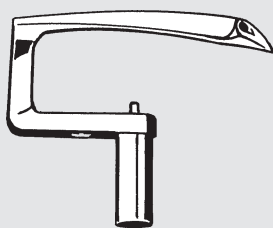

S 08913-001

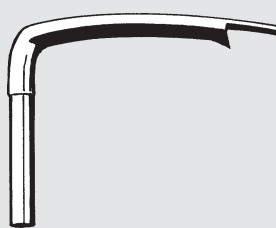

S 08934-001

B 281

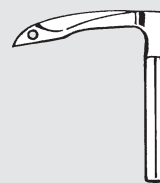

S 12842-001



S 12865-001



LH 4-B 812, B 814, B 815, B 816, B 860, B 800 E
HE-8000, HM-8180, HE-800 A
= Singer Kl. 71

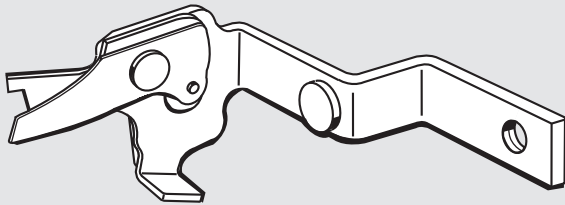

S 50404-401

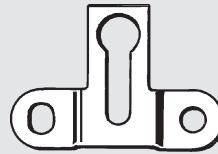

141543-001

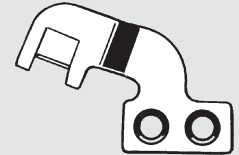

141541-001



S 50259-101

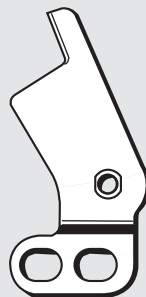

S 50260-101



S 50263-001

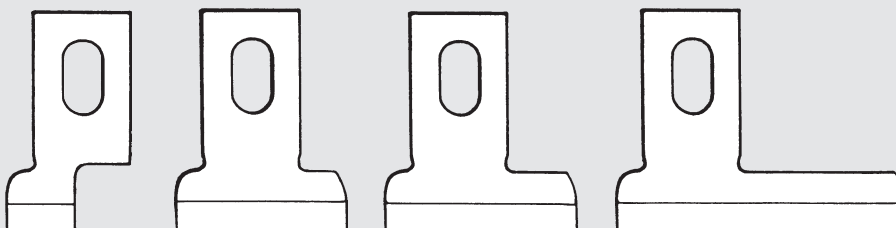
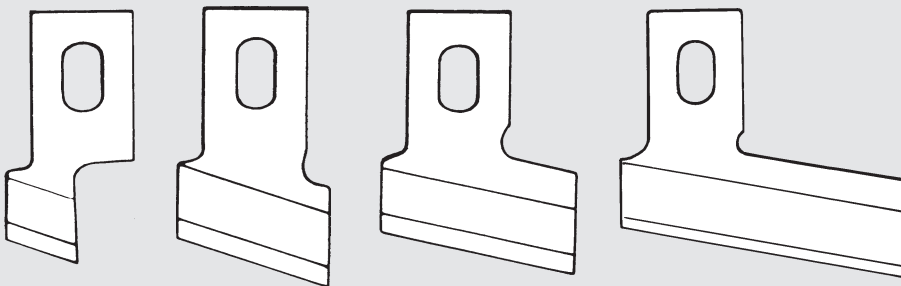

**HSS =
High speed steel
Acero rápido de alto
rendimiento**

71 1/8	71 13/16
71 1/4	71 7/8
71 5/16	71 15/16
71 3/8	71 1
71 7/16	71 1 1/16
71 1/2	71 1 1/8
71 9/16	71 1 3/16
71 5/8	71 1 1/4
71 11/16	71 1 3/8
71 3/4	71 1 1/2

71-90 1/8	71-90 5/8
71-90 1/4	71-90 11/16
71-90 5/16	71-90 3/4
71-90 3/8	71-90 13/16
71-90 7/16	71-90 7/8
71-90 1/2	71-90 15/16
71-90 9/16	71-90 1



DH 4-B 980
RH-9800, RH-9810, RH 981 A
RH-9820



S 35411-001



S 35410-001



SA 7634-101

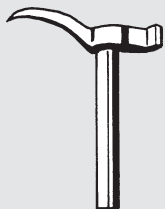

S 35412-101

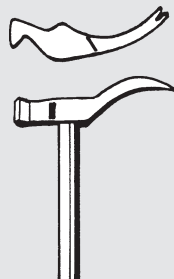

S 35413-101

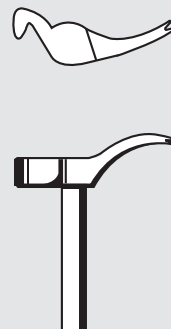

S 35472-101



S 34895-001



S 35029-001



S 37723-101



S 35033-001



S 35034-001



DH 4-B 980
RH-9800, RH-9810, RH 981 A
RH-9820

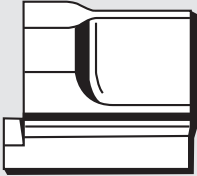

S 35092-001 20 mm
S 35093-001 38 mm

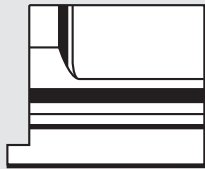

S 37195-001



S 37706-001



S 37708-001



S 35437-101 (38 mm 2,8 x 4,3)

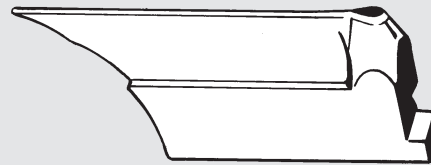

S 35480-101 (38 mm 3,0 x 4,6)

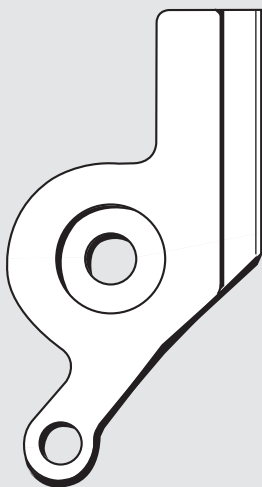

SA 6988-001

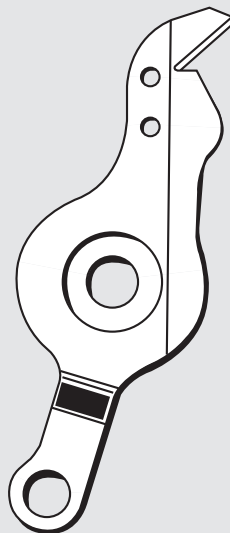

SA 6989-001



S 34899-001



DA 9270, 9280

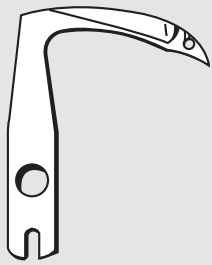

S 40389-001

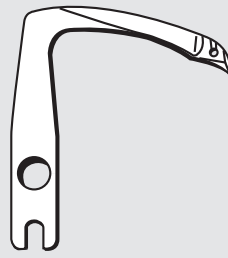

S 40390-001

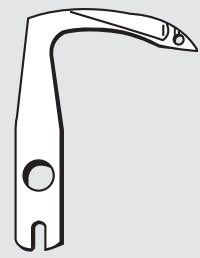

S 40391-001

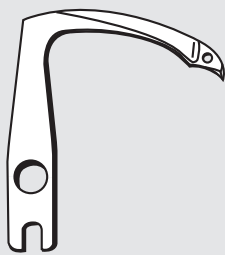

S 40392-001

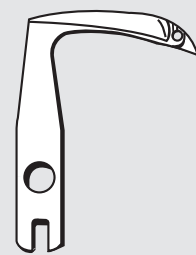

S 40393-001



S 40394-001

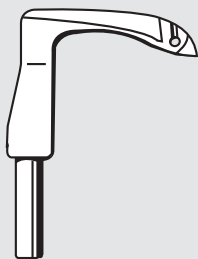

S 40375-001

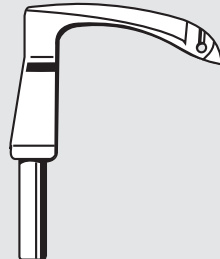

S 40376-001

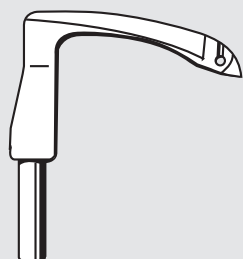

S 40377-001

LS 52-B 891



SSSS 60-302

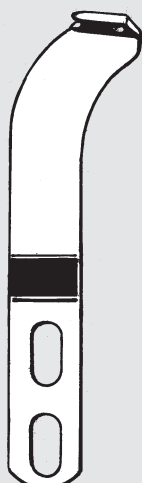

SSSS 60-292

ZE-856A



S 55863-101



S 55864-001



B 500 Series, B 600 Series, B 900 Series



140567-001

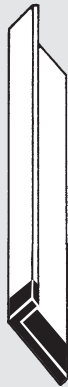

CT 140567-001



140242-001 (CT)



148815-001 (CT)



148198-001



144074-001 (CT)

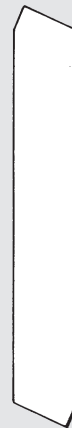

118527-001



144077-001



CT 144077-001



112436-001
155193-001



CT 112436-001



B 500 Series, B 600 Series, B 900 Series

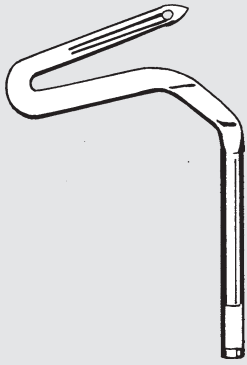

110736-001

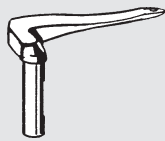

110737-001



147934-001
146042-001
146612-001



147935-001
146613-001

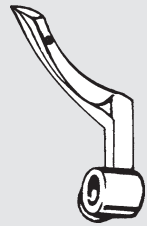

147936-001
146792-001

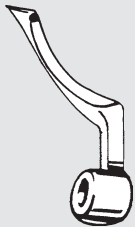

147937-001
146962-001



144042-001



159686-001



155240-001



155241-001

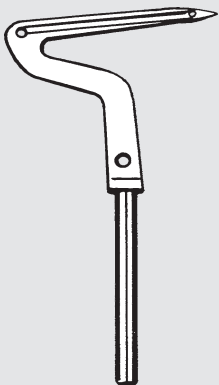

143734-001

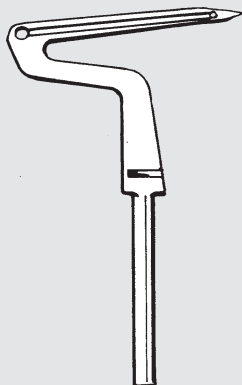

S 01248-001 (E)
144049-001

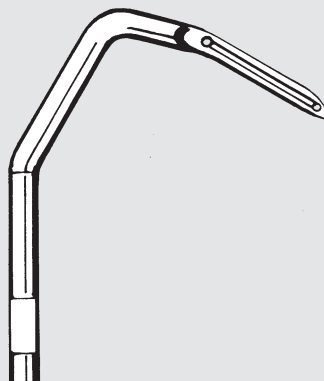

146635-001

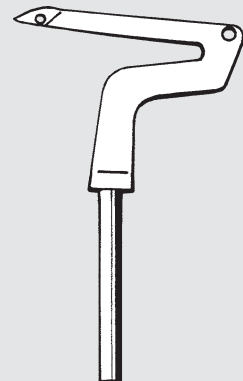

159434-001 (F)
S 01249-001



EF 4-V 41, -V 51, -V 71, -V 72, -V 81, -V 82
MA 4-N 11, -N 21, -N 31, MA 4-V 61, -V 91, -V 92



S 20896-001



S 20897-001



S 20579-001



S 20898-001



144074-001 (CT)



144074-300
144074-200



S 20899-001



S 20582-001



CT S 20582-001



S 20583-001

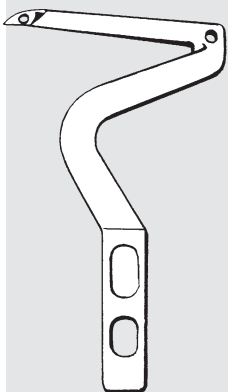

S 20626-001

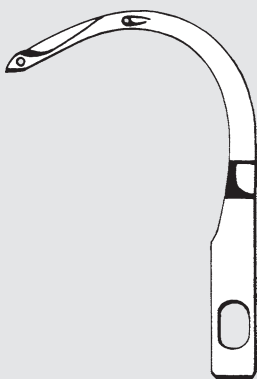

S 20653-001



S 20428-001
V 41 (C)



S 20438-001
V 41 (G)



S 20422-001
V 41 (A)



S 20424-001
V 41 (B)



S 20430-001
V 41 (D)



S 20434-001
V 51 (E)



S 20442-001
V 61 (R)



S 20421-001
V 61 (L)

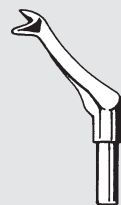

S 20429-001
V 61 (Q)



GP 1-71
7000010071



GP 2-71
7000020071



GP 3-4-71
7000030071



GP 5-71
7000050071



GP 4-93
7000040093



GP 7-71
7000070071



GP 7-93
7000070093



GP 8-71
7000080071

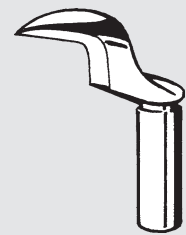

GP 8-93
7000080093



77

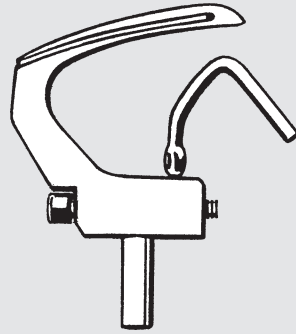

0077015050

68, 268, 368

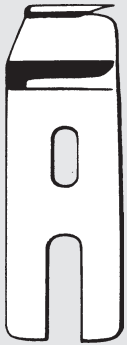

0068004600
68460

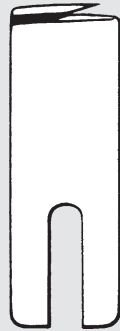

0068004620
68462
0268330470



68668-3,1



0268350030



0268350010

81



0081000820
81082



0081000660
81066



0083000820
83082



0081005820
81582 (CT)



0083000660
83066



67, 167, 267, 367, 467, 477, 550, 767, 768

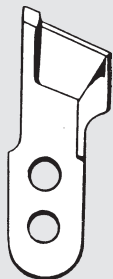

0367331330 (HSS)
067330570



0367331310 (HSS)
067330580



0367331320 (HSS)
067330700



0367331300 (HSS)



0067000460 (HSS)



0067351220



0167350010



0067351230



0067009360

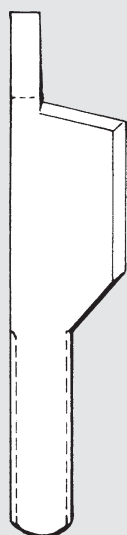

0367330780 (HSS)



0167004610



0167004620



0167330020 (CT)



0367210240 (HSS)



CT 367210240

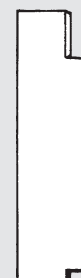

0477200140



67, 167, 267, 367, 467, 477
550, 767, 768

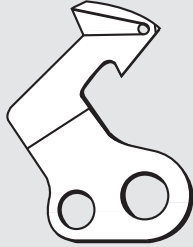

0367355030



0477330240

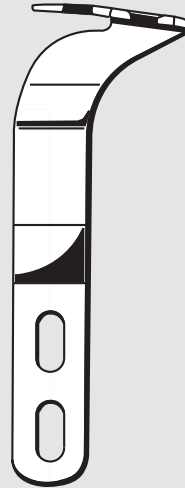

0767350280



0767350260



0367350070



0367350050



0467350330



0370221570

171, 173, 175, 195, 197
550
742, 743, 744
933, 939

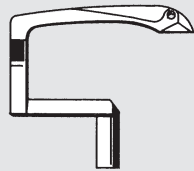

0933000337

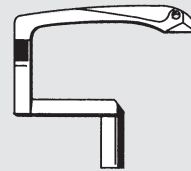

0933000337 A

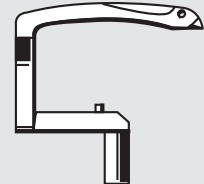

0195004753

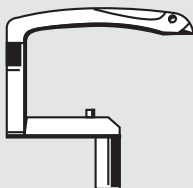

0195004753 A

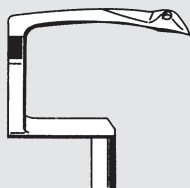

0195005055

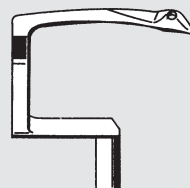

0195005055 A

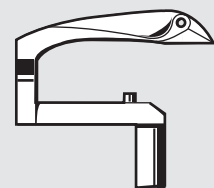

0171003253



171, 173, 175, 195
550
742, 743, 744
933, 939



0196104017



0171004602

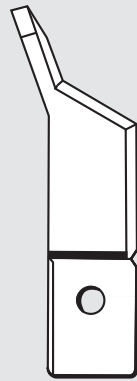

0195010127



0939017504

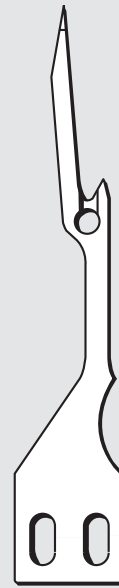

0933063983



0939017104



0933005712



0173003725

211, 212, 219
370, 380

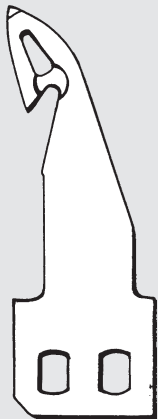

0219006708 A

227, 237, 238, 249, 265
697, 739-23

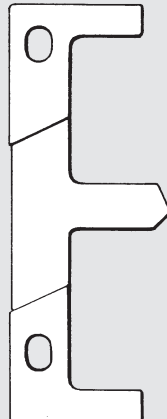

0211009685

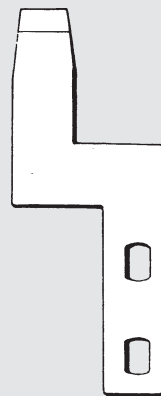

0211050366

271, 272, 273, 274, 275

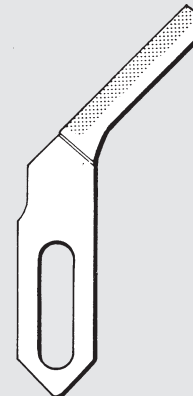

0212011368
0212005058 (CT)



0204001065
Kl. 237-22 und 23



0227000683

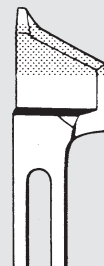

0212004931 (CT)



0227000682



0697002075 (CT)



0219003963
Solid carbide
Metal solide duro



211, 212, 219
370, 380

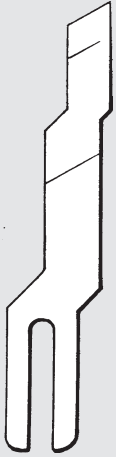

0238001418 (HSS)



0238001417 (HSS)



0238016496

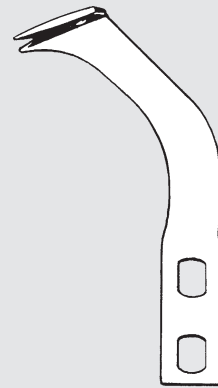

0380007293

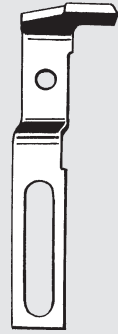

0238006549

227, 237, 238, 249, 265
697, 739-23

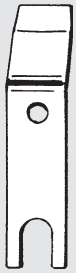

0271001497

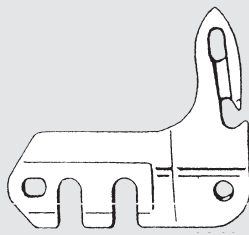

0271001483



0272076157



0272007042

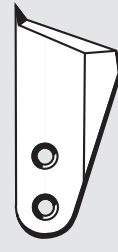

0272007045

271, 272, 273, 274, 275



0265008772



0211008504

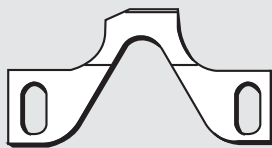

0265012265

244, 245, 246, 247
291, 292
745



0244014157



0291003002

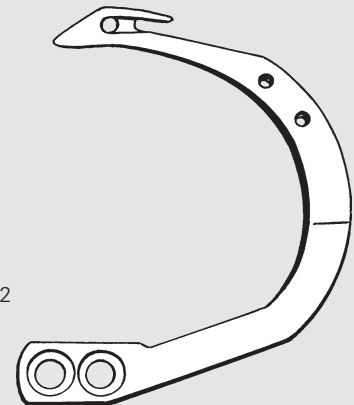

0291003004
0244014161



296



0296200020



0296330430 (CT)

396, 550



0396350750



0396200090



0396330690



0396330700

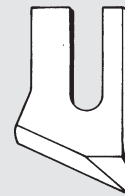

0396331600



0170200190

251

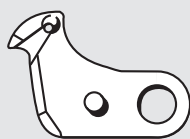

0251GR2438V2

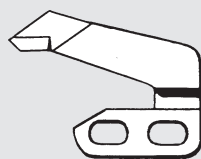

0251GR1705

564, 566

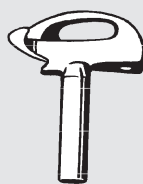

180614 DKP



0568330770



0568330760



0568350050

570, 579



0570000961

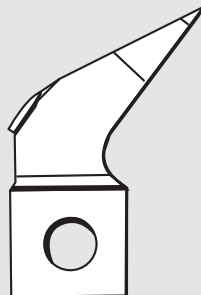

0570000962



0570092921

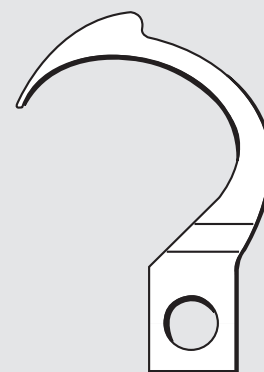

0570092925

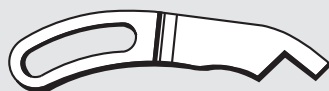

0570092917 A



0570092908 A



551, 555, 556, 576, 577, 540-100, 540-300

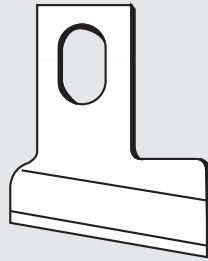
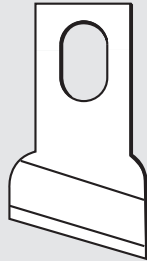

	mm		mm	Zoll
0576005701	6	0055000602	12,7	1/2
0576005702	8	0055000603	15,9	5/8
0576005703	10	0055000606	19,1	3/4
0576005704	12			
0576005705	14			
0576005706	16			
0576005707	18			
0576005708	20			
0576005709	22			
0576005710	24			
0576005711	26			
0576005712	28			
0576005713	30			

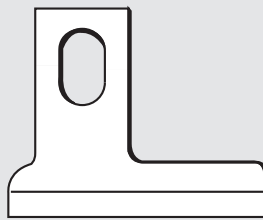
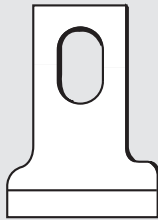

	mm		mm	Zoll
0576005721	6	0556007143	9,5	3/8
0576005722	8	0556007144	11,1	7/16
0576005723	10	0556007146	14,3	9/16
0576005724	12	0556007148	17,5	11/16
0576005725	14	0556007149	19,1	3/4
0576005726	16	0556007151	22,2	7/8
0576005727	18	0556007152	23,8	15/16
0576005728	20	0556007157	31,8	1 1/4
0576005729	22			
0576005730	24			
0576005731	26			

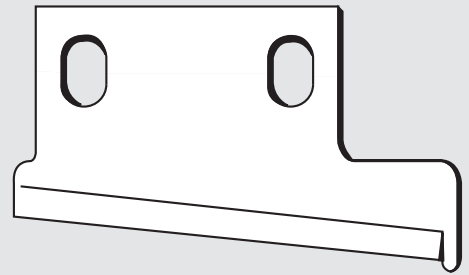
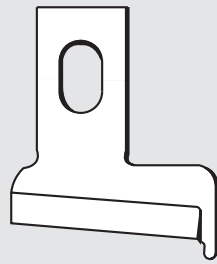

0540330110

0556013536

0556012783

0556012772

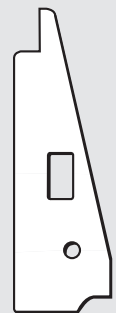
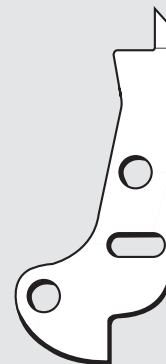
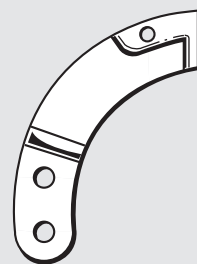
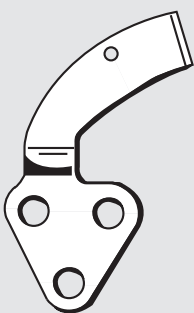

0577350230

0577350240

0577350080

0540350290

0540350340

0540350350



557, 558, 559, 578, 579, 580, 589



0557002872
(557605)
Bohrung 0,6



0557002872 A
Bohrung 0,8



0557003243
Bohrung 0,9



0557000602 A

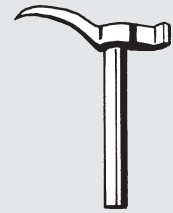

0557000611



0558009011

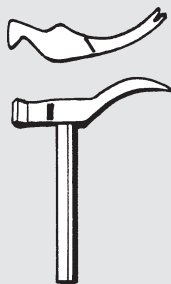

0557002876 K
(557614)

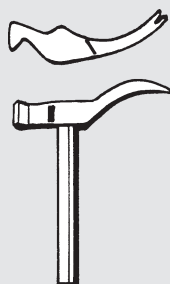

0557002035

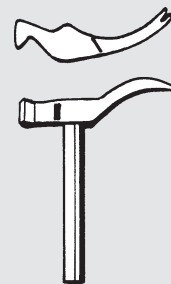

0557003398

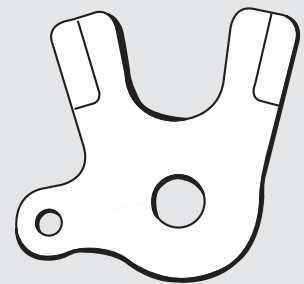

0557000593

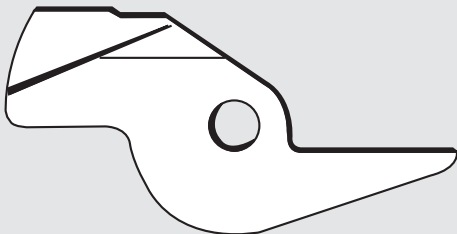

0558006110

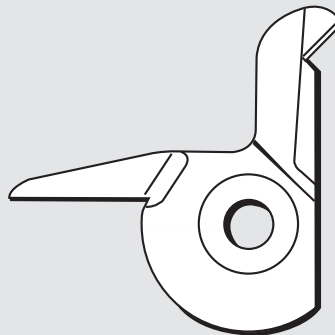

0558006109

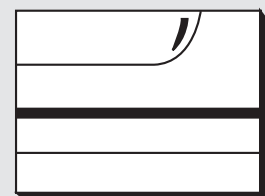

0557001684 MS
0557001686 MS

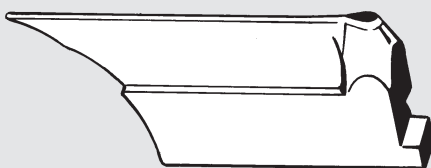

0558002561
0558002562
0558002566

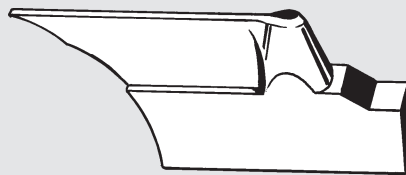

0558002564
0558002565
0558002567

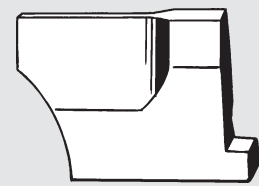

0558002405 16 mm
0558002406 18 mm
0558002408 22 mm
0558002410 26 mm
0558002411 28 mm



557, 558, 559, 578, 579, 580, 589

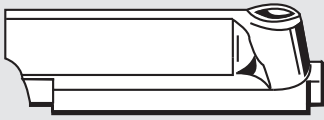

0578003363

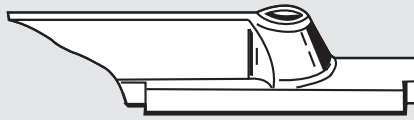

0578003365

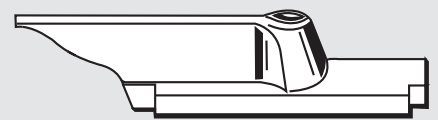

0578003366

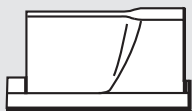

- 0578003281 10 mm
- 0578003282 12 mm
- 0578003283 14 mm
- 0578003284 16 mm
- 0578003285 18 mm
- 0578003286 20 mm
- 0578003287 22 mm
- 0578003288 24 mm

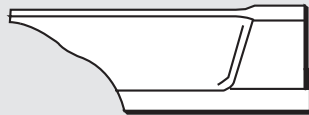

- 0578003289 26 mm
- 0578003290 28 mm
- 0578003291 30 mm
- 0578003292 32 mm
- 0578003293 34 mm
- 0578003295 38 mm

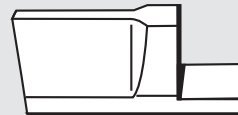

- 0578003323 20 mm
- 0578003324 22 mm

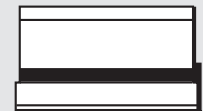

- 0578003304 12 mm
- 0578003308 20 mm
- 0578003309 22 mm
- 0578003311 26 mm
- 0578003314 32 mm
- 0578003315 34 mm
- 0578003316 38 mm

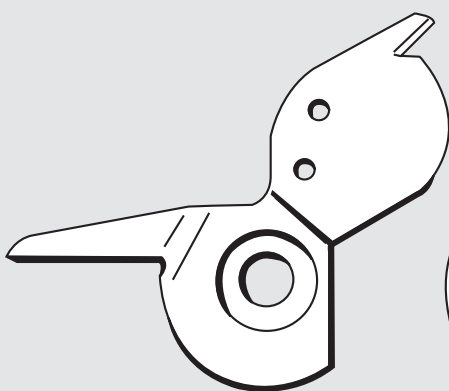

0558008816



0558008817

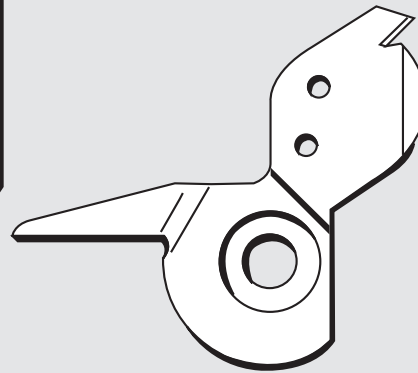

0558008858



0558008859

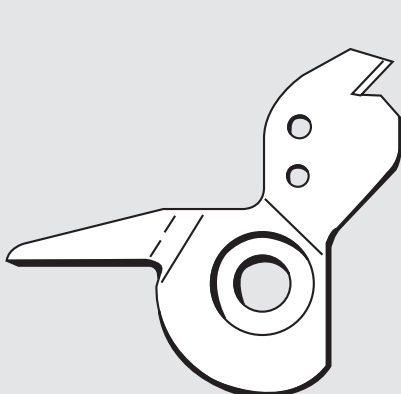

0558008868

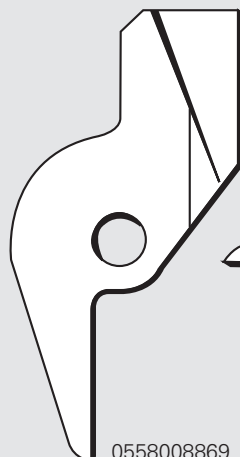

0558008869

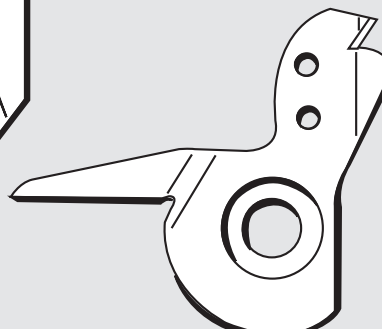

0558008878

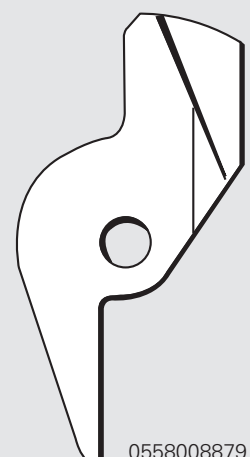

0558008879



580



0558002552

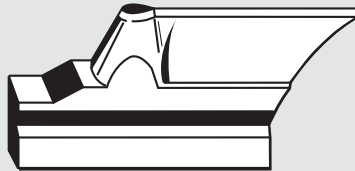

0558006855

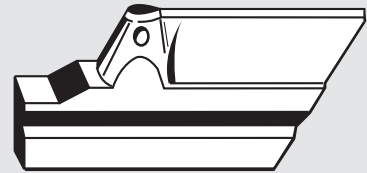

0580330370



0580330390

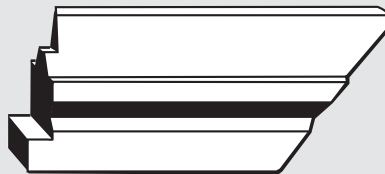

0580330400

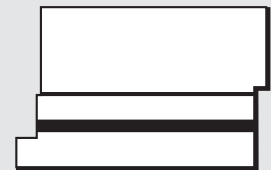

0580330300

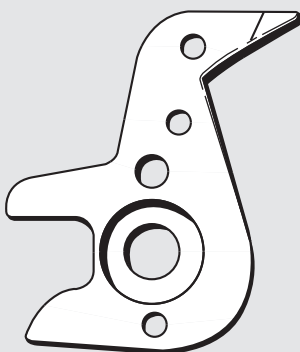

0580350280

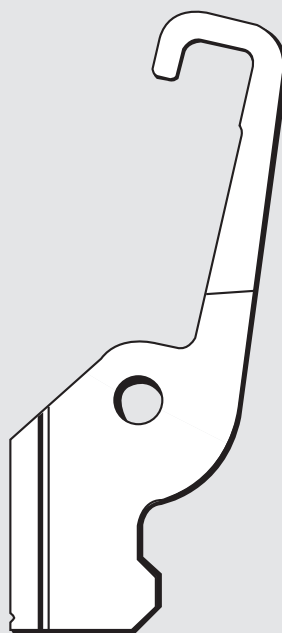

0580350270

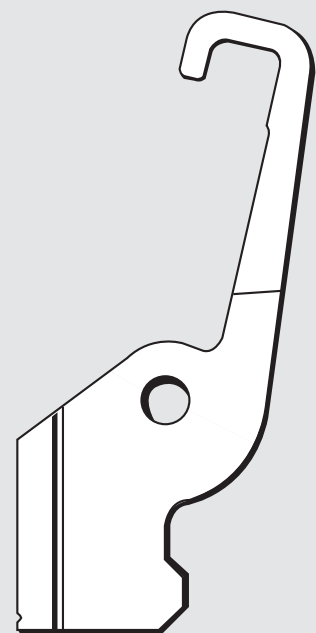

0580350970



**745, 746, 748, 749, 745-34 S
745-21, 745-22**



0246002553

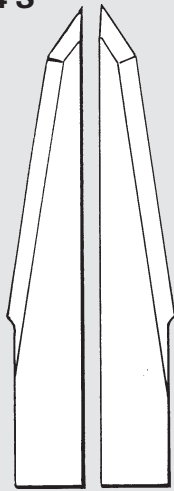

0746060689 0746060690

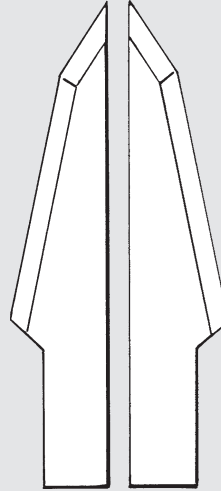

0746060691 0746060692

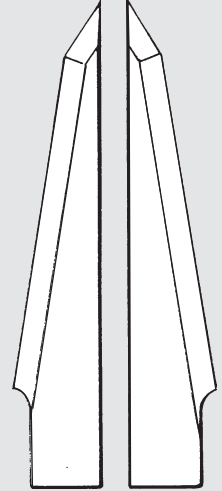

0746000995 A 0746000995

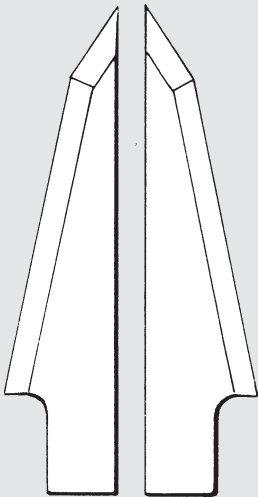

0746000996 A 0746000996

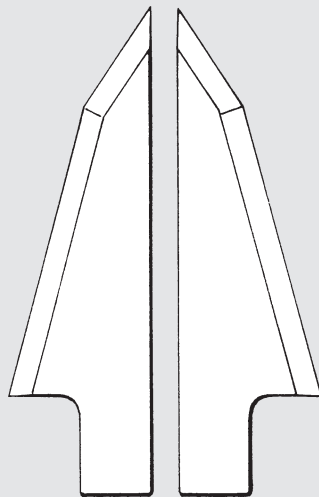

0746000997 A 0746000997

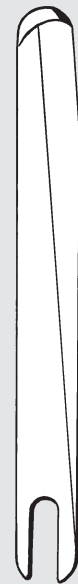

0748000419

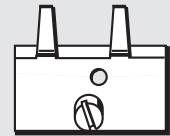

0246002401

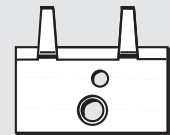

0246002402

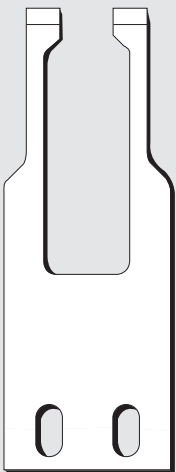

0246350040

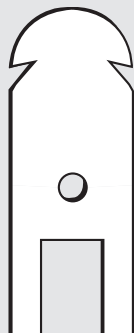

0246350060

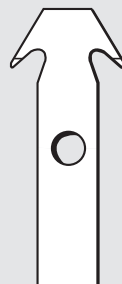

0246000595

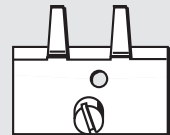

0246002405

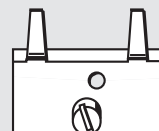

0246002408

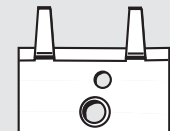

0246002409



Beisler

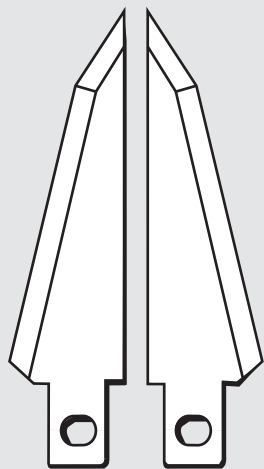

004537.00 004538.00

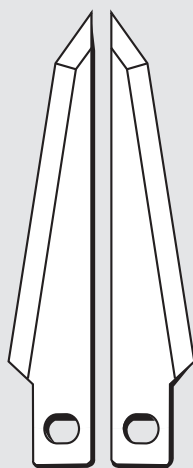

004539.00 004540.00



2500895.00

867

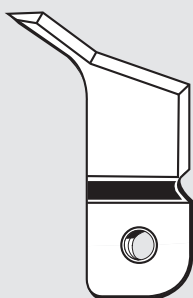

0867330270



0867330280



0867330430

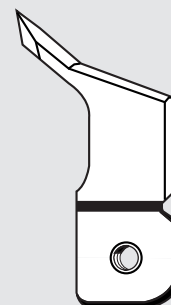

0867330570

1296

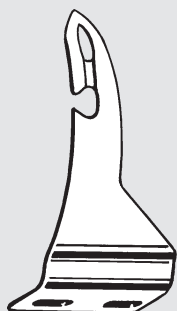

0129175540



0129171853

510, 530, 910

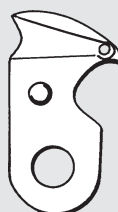

0510 B 2421-280-0A0

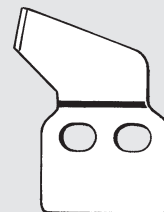

0510 B 2424-280-000



0510350060



3000

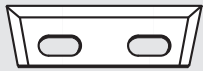

0793027524

971



0971440140



0971440180

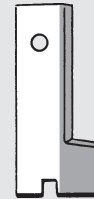

CT 971440140



CT 971440180

4120 i, 4180 i, 4181 i, 4182 i, 4182 i - 147
4220 i, 4280 i
888

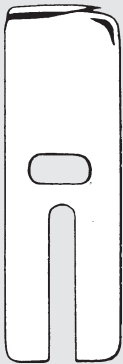

S 425311020 = 2,7

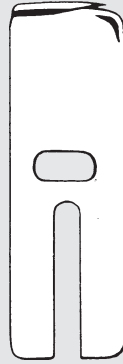

S 425311020 HSS = 2,7
S 425311026 HSS = 3,5



S 425311023



S 425311024



S 425311018



S 425311018 HSS



S 425311021



S 425311021 HSS



S 080870223



S 080870238



S 080870239



S 425870237
Solid carbide
Metal solide duro



21-5602
Kl. 1010/1020:
520087
Kl. 2001:
6502114
PL-2-13



21-3002
21-4012
520018
PL-2-30 (CT)



21-4587
512035



21-3003
650704
527013
PL-9-9
HSS



15487
21-3003-01
6507044
Ceramic



21-4001
520002
Kl. 1005F/1005FZ



21-3004
512018
Kl. 1002



MS 3-017 L

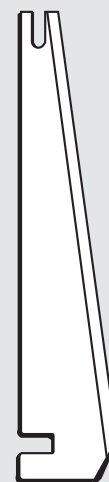

MS 3-017 R

MUSASHI-21



MO 800 Series, MO 1500 Series
MO 2000, 2400, 2500 Series, MO 3300, 3600, 3700, 3900 Series
MOC 3904, 3914 = Union SP 100
MOR, MOJ 3916
MO 6100 Series, MO 6700 Series, MO 6900 Series

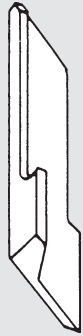

B 4111-804-000

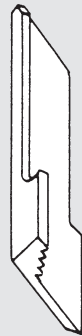

B 4111-804-00D

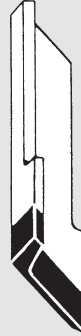

B 4111-804-00A (CT)

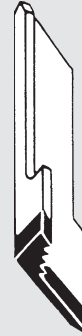

B 4111-804-00E (CT)

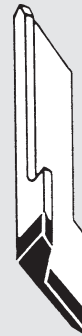

B 4111-804-00C (CT)



B 4118-804-000



B 4118-804-00C



CT B 4118-804-000



CT 118-45906

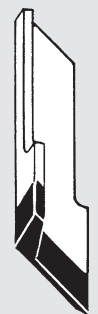

CT 118-45807



CT 118-45807 G



115-65900 (CT)



118-45609 (CT)



118-47407



118-45708 (CT)



118-47506



MO 800 Series, MO 1500 Series
MO 2000, 2400, 2500 Series, MO 3300, 3600, 3700, 3900 Series
MOC 3904, 3914 = Union SP 100
MOR, MOJ 3916
MO 6100 Series, MO 6700 Series, MO 6900 Series



120-04909 (CT)



124-45508 (CT)



131-50503 (CT)



131-50602 (CT)

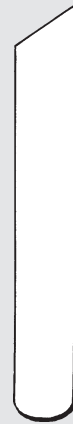

118-46003



118-97501



115-98406



115-66502



122-20307



124-47504



131-50701

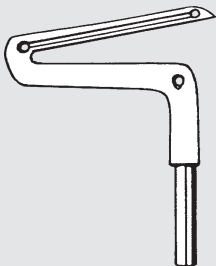

B 2521-804-000

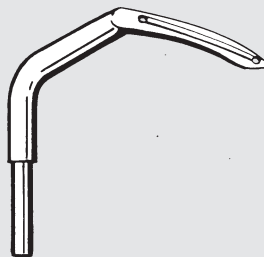

B 2118-816-000

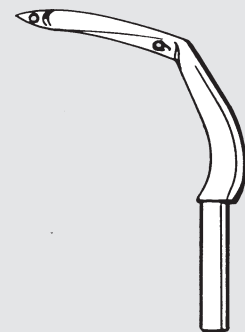

115-39202



B 2519-804-000



B 2519-814-000



B 2514-803-000



**MO 800 Series, MO 1500 Series
MO 2000, 2400, 2500 Series, MO 3300, 3600, 3700, 3900 Series
MOC 3904, 3914 = Union SP 100
MOR, MOJ 3916
MO 6100 Series, MO 6700 Series, MO 6900 Series**



115-44806



116-81301

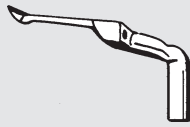

118-88005



118-88104



118-88203

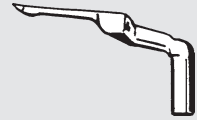

118-88302

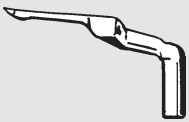

118-88609

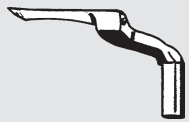

119-91403

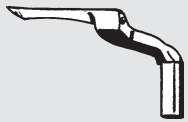

119-91908

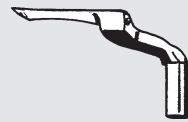

119-93607

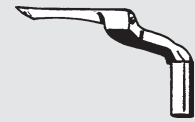

119-99208

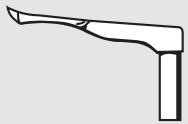

120-14908

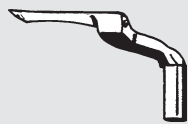

121-76004

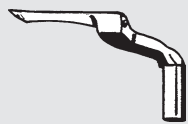

121-76103

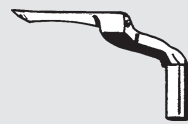

121-76202

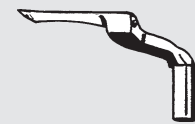

122-47102



122-47508



123-83501



123-83600

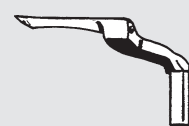

124-81107

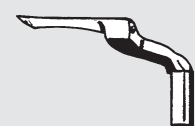

124-81008

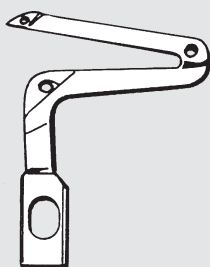

118-88401

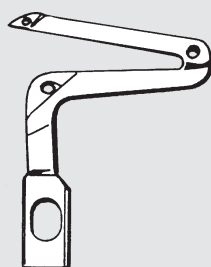

118-88500

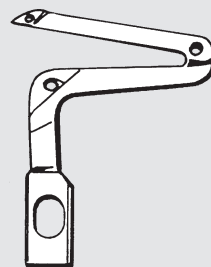

118-88501

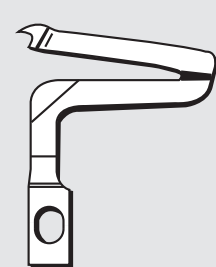

118-88708



MO 800 Series, MO 1500 Series
MO 2000, 2400, 2500 Series, MO 3300, 3600, 3700, 3900 Series
MOC 3904, 3914 = Union SP 100
MOR, MOJ 3916
MO 6100 Series, MO 6700 Series, MO 6900 Series

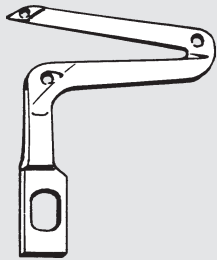

118-89904

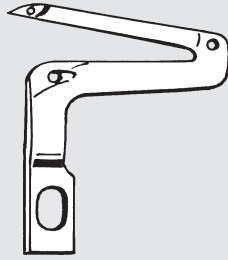

119-99307

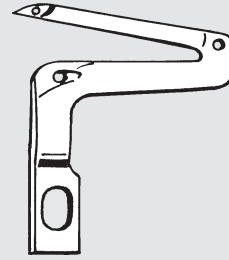

119-99802

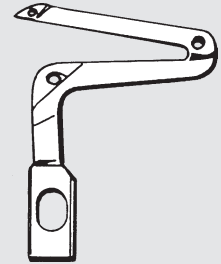

122-40107

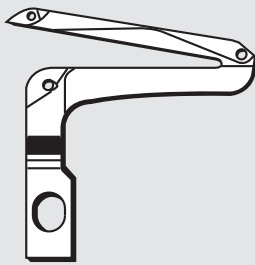

123-84202

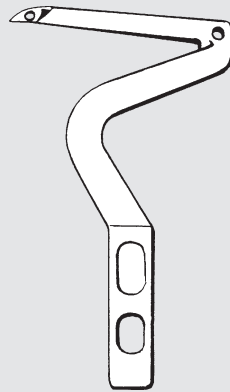

124-81800

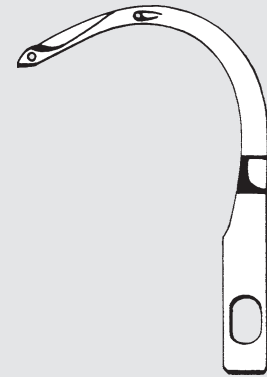

124-82600

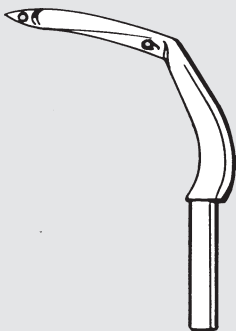

118-29405

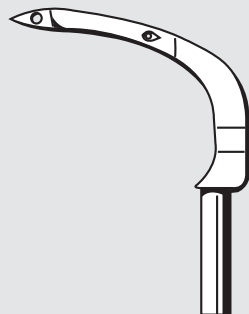

120-03604

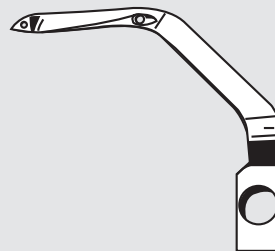

121-20705

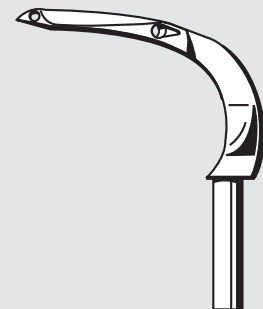

123-84400



**MO 800 Series, MO 1500 Series
MO 2000, 2400, 2500 Series, MO 3300, 3600, 3700, 3900 Series
MOC 3904, 3914 = Union SP 100
MOR, MOJ 3916
MO 6100 Series, MO 6700 Series, MO 6900 Series**

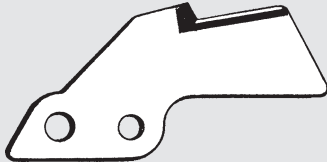

MAT-0220 3000 (CT)
T 022, T 035

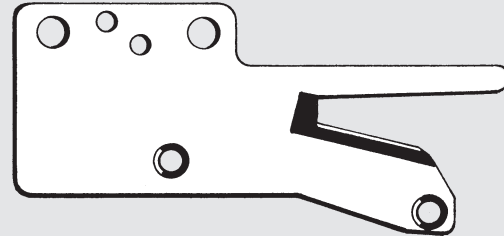

MAT-0220 4000 (CT)
T 022, T 035

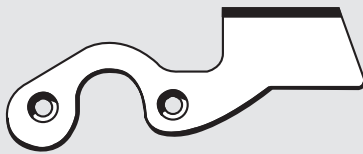

MAT-0350 6000 (CT)

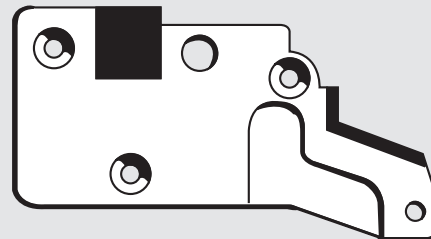

MAT-0350 5000 (CT)

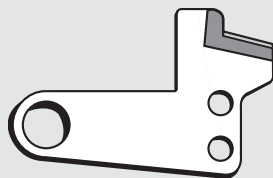

MAT-0360 6000 (CT)

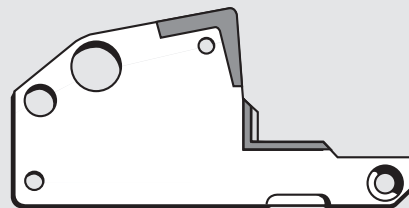

MAT-0360 500A (CT)

MH 1410

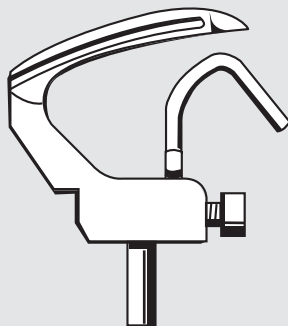

311-54503

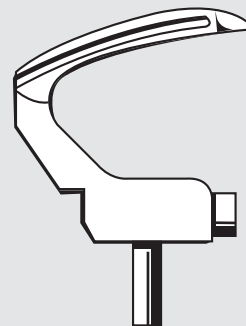

311-54602



MO 102, 103, 104, 202, 204, 234, 305, 335 Bernette



B 4108-352-00D (CT)



A 4113-102-000



A 4142-335-000 (CT)



A 4145-335-000

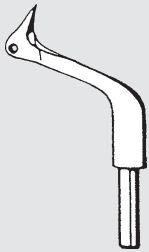

A 2512-102-000

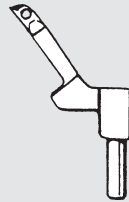

A 2512-103-000

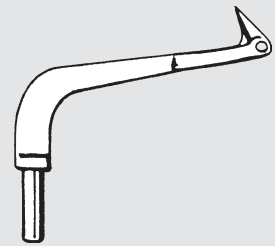

A 2511-202-000

MO 352, 357



B 4108-352-00D (CT)



B 4122-352-00 A

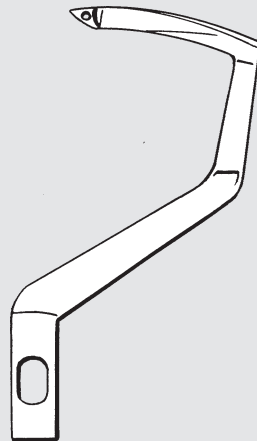

B 2011-357-000

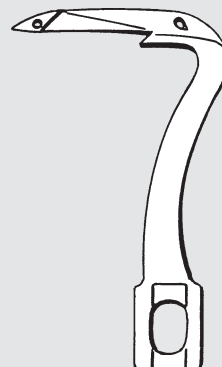

B 2521-352-000

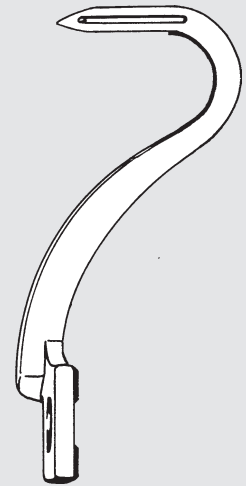

B 2520-352-000

PLW 1257



106-46909



106-50703



**AMS Series
LK Series
MOL 254**



138-81255

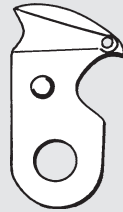

B 2421-205-0A0



B 2421-210-000



B 2421-210-AA0

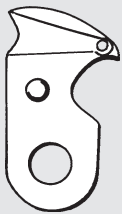

B 2421-280-0A0



B 2424-210-000



B 2424-210-A00

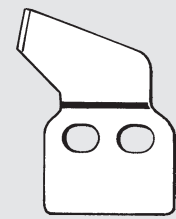

B 2424-280-000

**DDL 555, 5550, 5570, 5580, 5600, 5700, 9000, 9000 A, 9000 B
DDL 850-7, 8500-7, 8700-7
DLN 415, 5410, 6390-7, 9010, 9010A
DLD 5430
DLU 5490 N-7**



D 2402-555-BA0



D 2402-555-BAB



D 2402-415-BA0

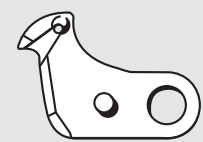

110-40052

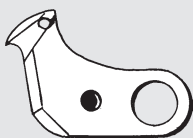

110-93259

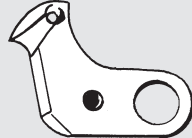

113-13053



114-08150



114-09257

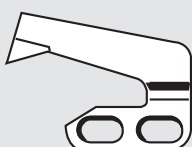

114-09604

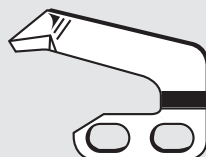

400-00324

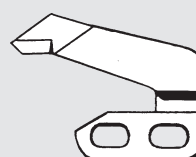

D 2406-555-BO0

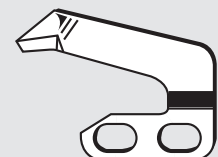

D 2406-555-DOH



LU Series



107-26404



213-89309

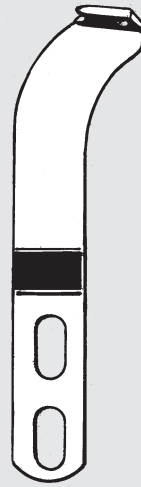

107-26305

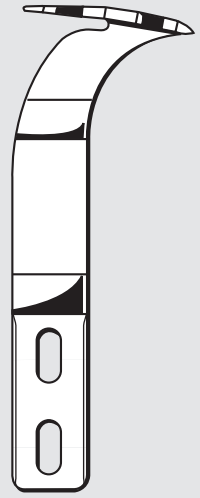

213-89200

LH 1152, 1162, 1164

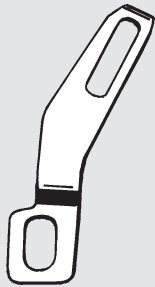

102-11209

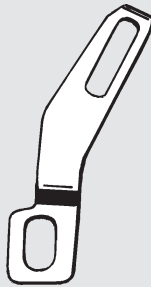

102-32403

**LH 3500, 3500 A
LH 3528, 3568
LH 4128, 4168**

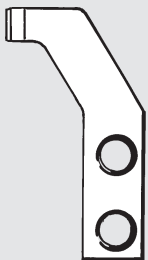

400-12404



400-12403

**LH 3120, 3126, 3128, 3162, 3178,
3182, 3188**

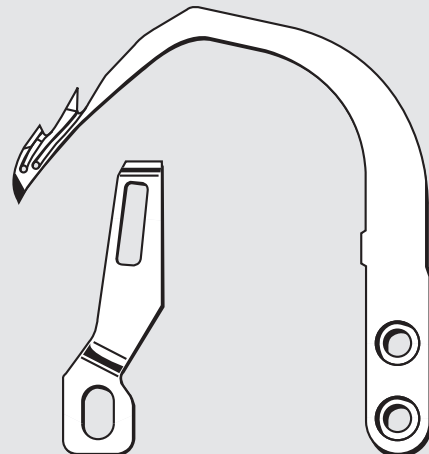

226-55302

102-11605



**DLM Series
DMN Series**

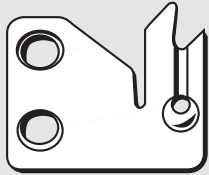

113-51400



113-51509



B 4121-052-A00



B 4121-522-000

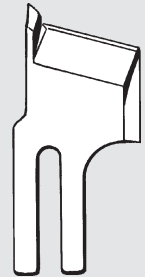

B 4145-530-B00

MF 850, 860, 880, 890, MF 2600, MFB 860, MFB 2600

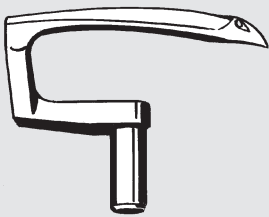

B 2514-860-G00



MAS-11012-000



MAS-11013-000

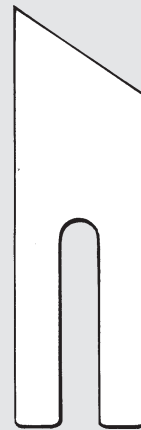

MAS-11016-000

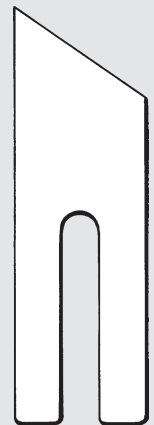

MAS-11017-000

MH 481, 484

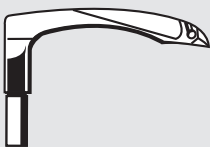

B 2030-481-000

MH 380, 382

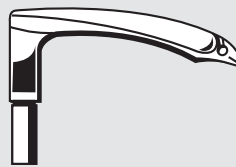

B 2030-380-000

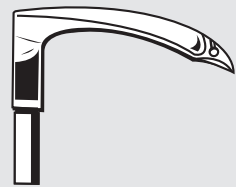

B 2031-380-000

MF 7000, MFC 7000

siehe Union CS/FS 100 Seite 109
see Union CS/FS 100 page 109
véase Union CS/FS 100 Página 109

**MF 7600, 7700, 7800
MF 7200 D
MF 7800 D**

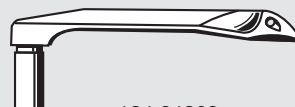

134-24809



MS 1260, 1261, 1261 M

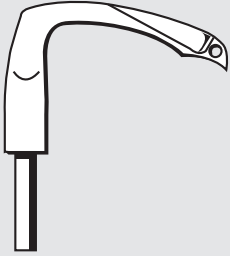

129-68509 (L)

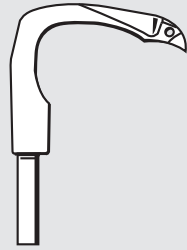

129-68806 (R)

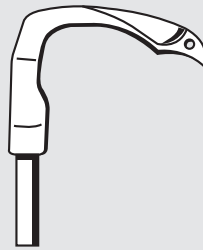

129-69101 (C)

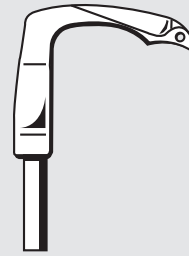

129-79308 (C)

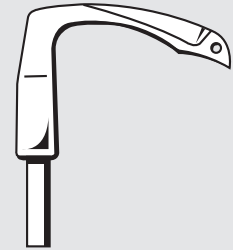

129-79209

MS 1190

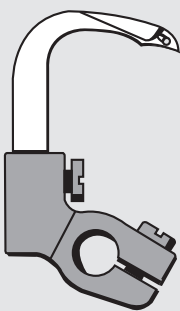

129-41050

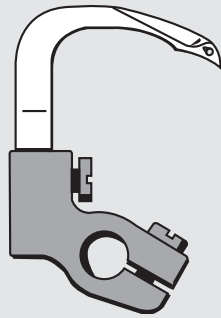

129-41852

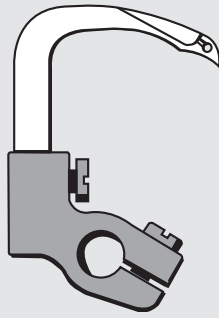

129-41951

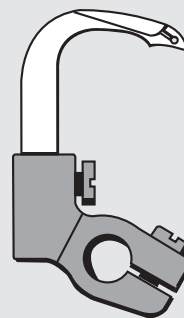

129-40557

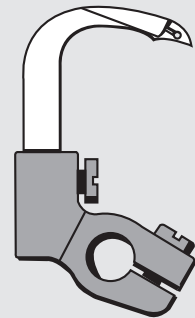

129-40953

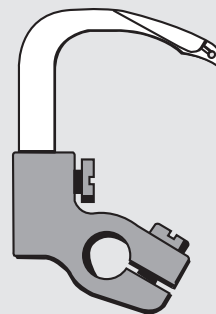

129-41456

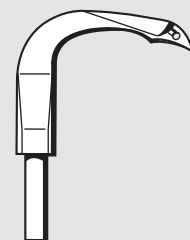

129-40508

DU 141 H-7

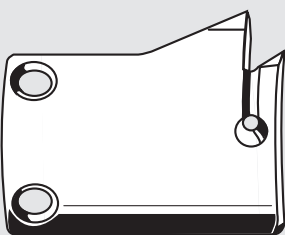

D 2423-141-E00



D 2424-141-E00

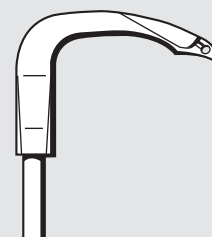

129-41407

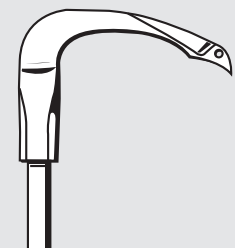

129-41555



PLC 1610, 1660

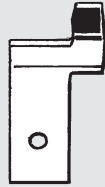

230-05903



230-05804

APW Series



164-16109
164-18600
SUPER-Stahl
SUPER-steel



164-18709
164-18006
SUPER-Stahl
SUPER-steel



166-07400
SUPER-Stahl
SUPER-steel



166-07301
SUPER-Stahl
SUPER-steel



254-43805
SUPER-Stahl
SUPER-steel



254-46808
SUPER-Stahl
SUPER-steel

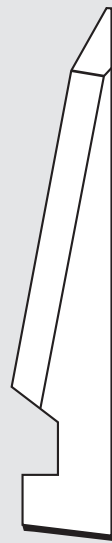

166-07608
SUPER-Stahl
SUPER-steel



166-07509
SUPER-Stahl
SUPER-steel



LBH 761-763, 771-773, 781-784, LBH 793
LBH 1700, LBH 1790, LBH 781NS
ACF 172-1790

HSS=
High Speed steel
Acero rápido de
alto rendimiento

= Singer Kl. 71

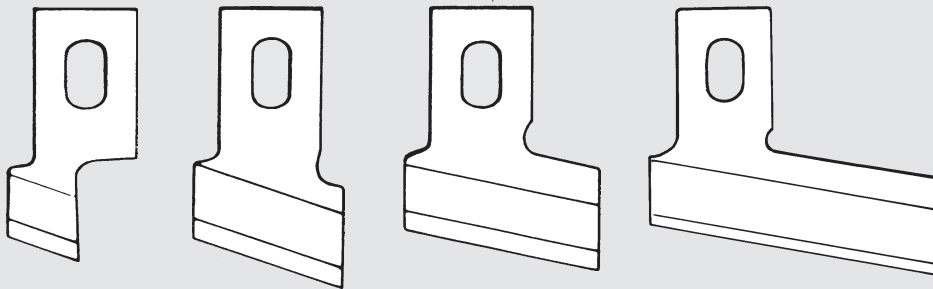

- B 2702-047-F00 1/4"
- B 2702-047-K00 3/8"
- B 2702-047-I00 7/16"
- B 2702-047-L00 1/2"
- B 2702-047-V00 9/16"
- B 2702-047-M00 5/8"
- B 2702-047-A00 11/16"
- B 2702-047-N00 3/4"
- B 2702-047-P00 7/8"
- B 2702-047-Q00 1"
- B 2702-047-S00 1 1/4"
- B 2702-047-R00 1 1/8"

= Singer 71-90

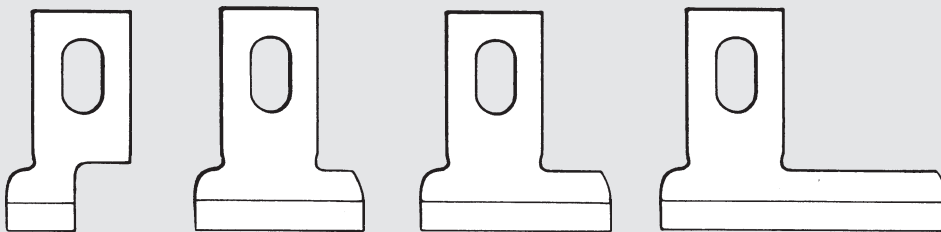

- B 2745-771-F00 1/4"
- B 2745-771-K00 3/8"
- B 2745-771-L00 1/2"
- B 2745-771-H00 9/16"
- B 2745-771-M00 5/8"
- B 2745-771-N00 3/4"
- B 2745-771-P00 7/8"
- B 2745-771-Q00 1"

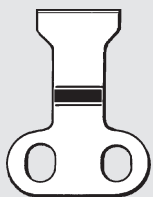

B 2408-761-000

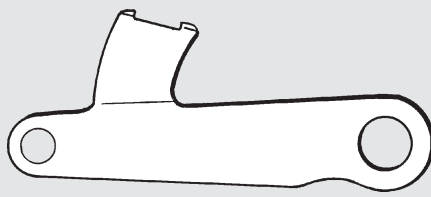

B 2406-761-0A0

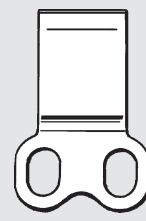

B 2408-771-000

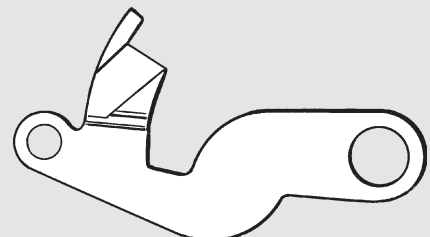

B 2406-771-0A0

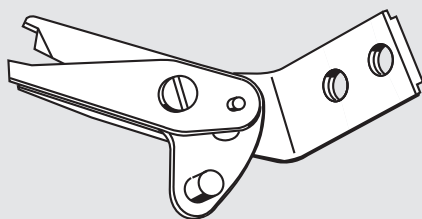

B 2001-771-0A0

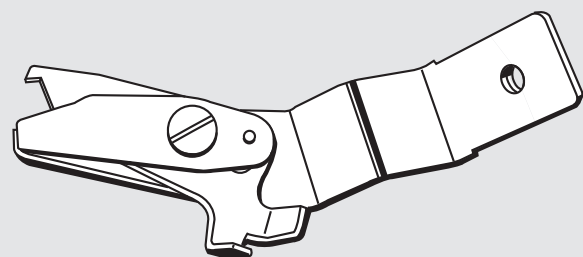

400-04255



MBH 180, MEB 1890 = Reece S 200

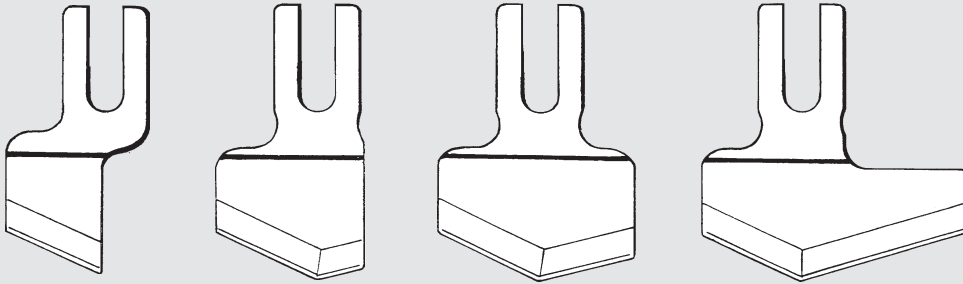

- B 2701-180-F00 1/4"
- B 2701-180-K00 3/8"
- B 2701-180-L00 1/2"
- B 2701-180-V00 9/16"
- B 2701-180-M00 5/8"
- B 2701-180-N00 3/4"
- B 2701-180-P00 7/8"
- B 2701-180-Q00 1"
- B 2701-180-R00 1 1/8"
- B 2701-180-S00 1 1/4"
- B 2701-180-T00 1 3/8"

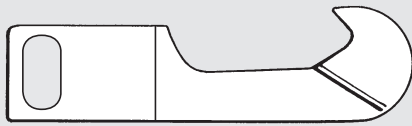

B 4002-180-000



B 1109-180-000



B 4001-180-000



B 2523-180-000



B 2524-180-000

LZ 2280, 2282, 2282 N, 2282 NU, 2286 NU, 2288 NU, 2290

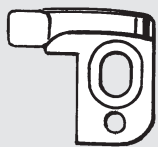

235-06009



CT 235-06009



225-57706



225-57557



CT 235-06108
Solid carbide
Metal solide duro

**MB 372, 373, 377, 1370, 1373, 1377, 1800
AMB 289**



B 1239-372-000

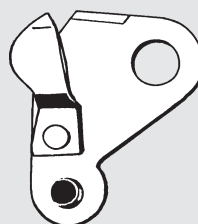

B 2406-373-0A0



B 2410-373-000



MEB 2688, 3200



140-30803



140-30902



320-40800



400-15694



140-31017

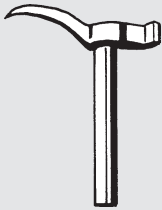

140-31009

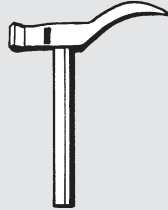

140-31108

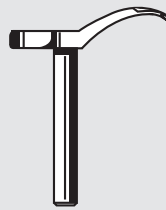

140-31116

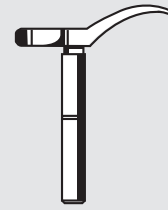

400-15684



400-15685

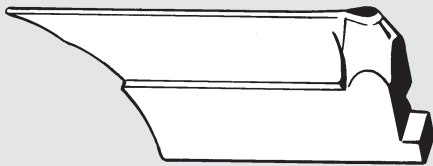

140-41206



320-23319



320-16107



320-18509



320-18012

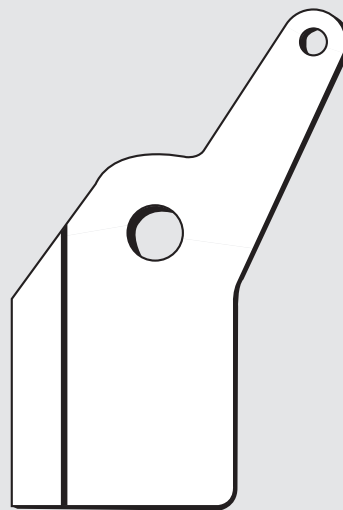

320-20505

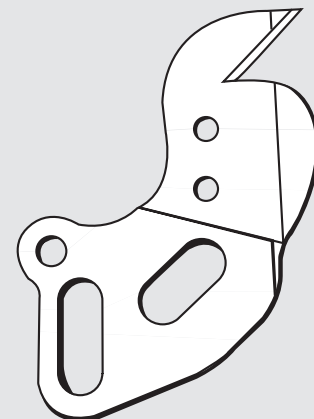

400-15996



Babylock EF 205, 405, 406, 434, 436, 605, 738
BL 3-408, 418
BL 4-605

SL 330, 500, 800, 803, 843
BL 3200



305249



205-9102-01 A (CT)



305248
205-9101-01 A



405-9102-01 A



408-9101-01 B



408-9102-01 A



PL-Q11-01 A

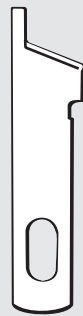

PL-Q11-01 C



PL-R11-01 A



SE-R11-01 A

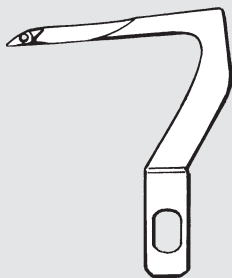

418-6101-02 A



714-6101-01 A



60507 (CT)

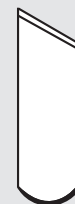

60544



**DPW-1300 / PX-302
V 7102 ML**

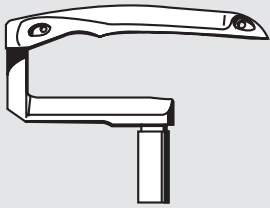

19-351

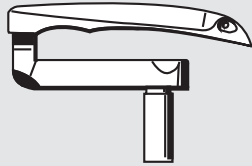

19-353

**DFB
BX**

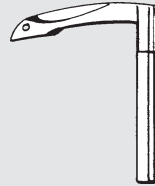

19-431



19-437

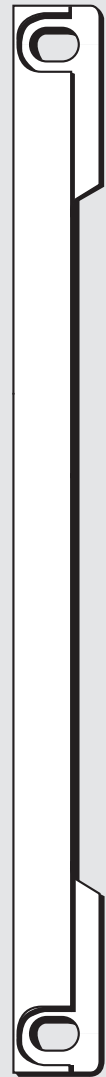

05-429

DLR

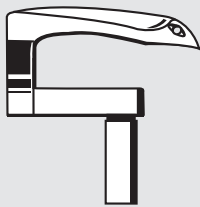

19-512

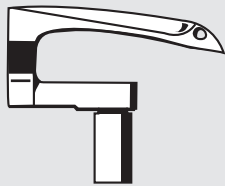

19-514

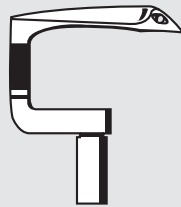

19-518

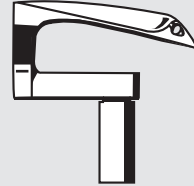

19-521

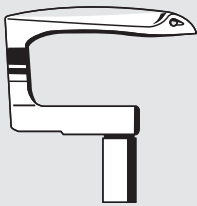

19-522

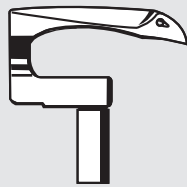

19-546

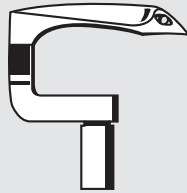

19-547

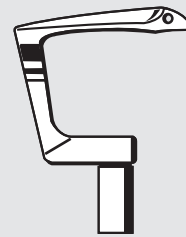

19-548

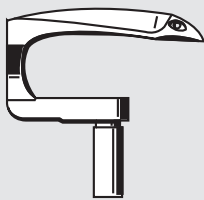

19-535

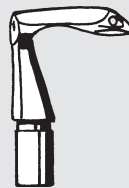

19-581



19-582

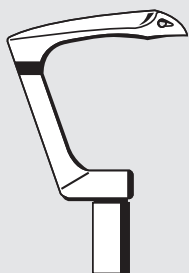

19-549



19-583

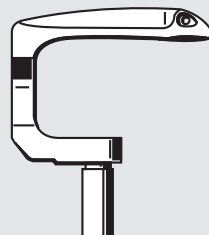

19-536

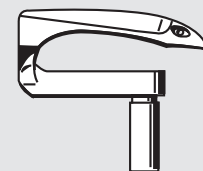

19-531



**DVK 1700
DVK 3200**

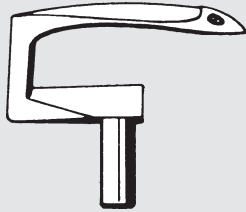

19-703-0

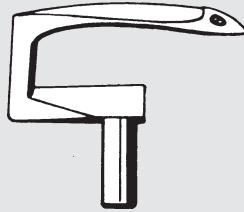

19-712

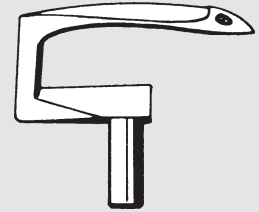

19-713



07-406 (CT)



07-124 (CT)



07-206

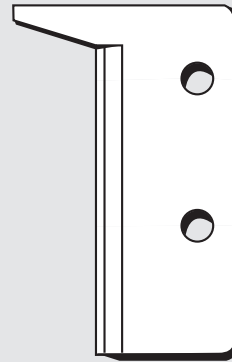

52-275

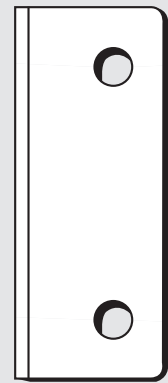

52-288

**DVK 1700
DVKB-2000
BLX 2200**



07-702 (CT)



07-703 (CT)



07-707

W 8100



07-168
07-170



07-169



**W 8002, 8003, 8103
V Series
VW Series**

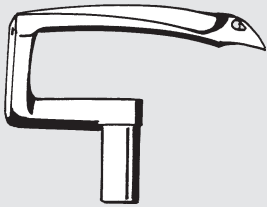

19-801

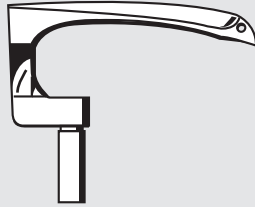

19-814

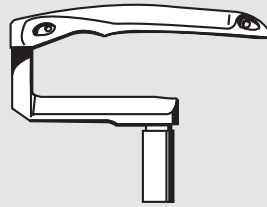

19-351



19-807

WX, LX, MC 30



07-558

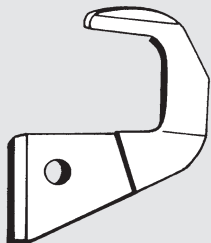

07-570 (CT)



07-507

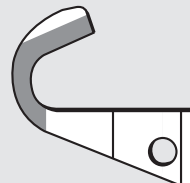

07-505 (CT)



05-812



05-658

RX-, WX-, BLX Series

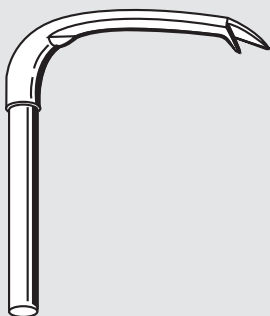

19-505

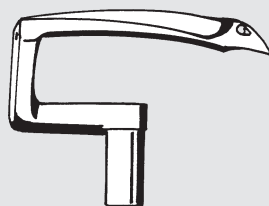

19-539

**DX-, RX Series
MZ Series**

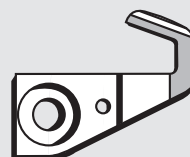

07-544

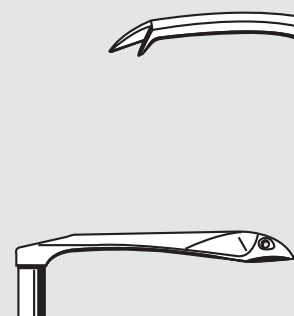

19-525



19-505



SH-6000 Series
(Global, Pfaff, Singer usw.)



377462 (CT)
6031314 C 500

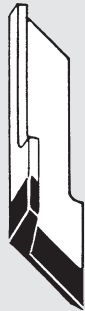

344559 (CT)

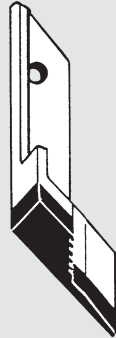

377465 (CT)



377559 (CT)
G 6050113 C 500

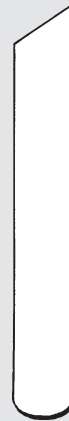

377443
6031218 P 700



377560
G 6050114 P 700

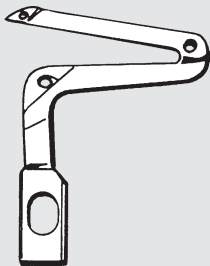

377602
LL 603884

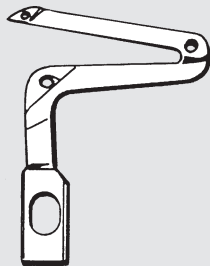

377640
LL 604885

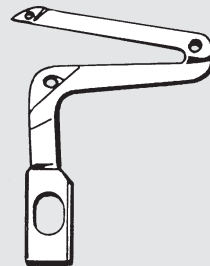

377641
LL 604884
LL 600884

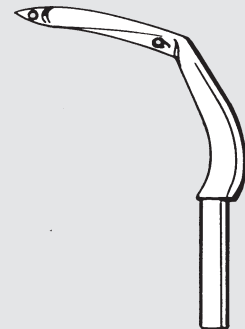

UL 605294

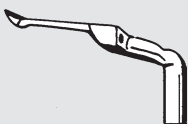

377600 (A)
UL 603880
UL 600880

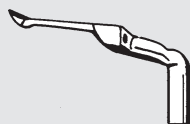

377601 (C)
UL 603886
UL 600886

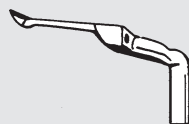

377638 (D)
UL 604883
UL 600883

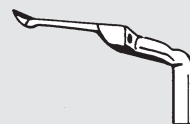

377639 (F)
GUL 604152

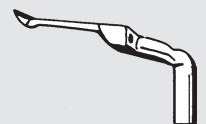

377740 (B)
UL 603881
UL 600881



Baureihe 10, 40, 50

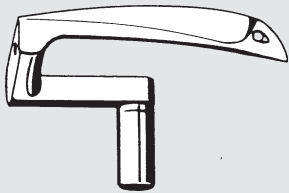

96-712082-05
Kl. 10, 50



96-705142-05

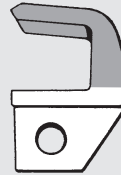

CT 705142

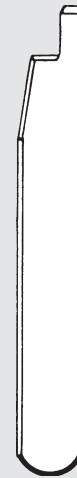

96-700591-05 (HSS)
CS 816



CT 700591



96-700535-05 (HSS)
ZA 815



CT 700535

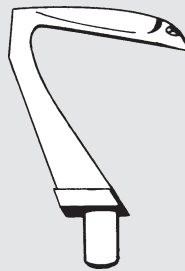

96-700565-05
CS 37
Kl. 40

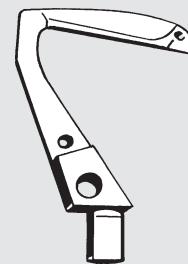

96-722820-05
Kl. 40



96-701080-05



96-722166-05

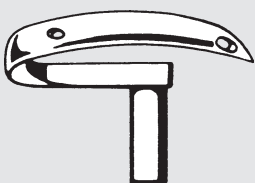

96-702750-05
AP 37 B

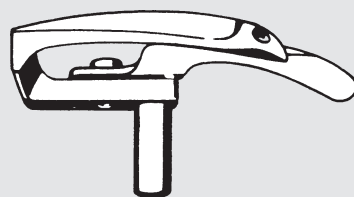

96-702417-91
AH 37 E

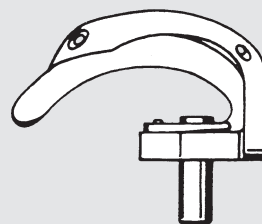

96-706509-05
CHG 37

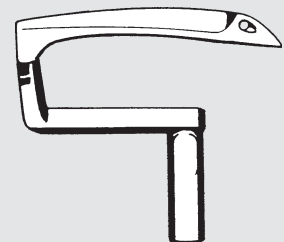

96-710414-05
F 23100-37 A



OAH, ODA usw.

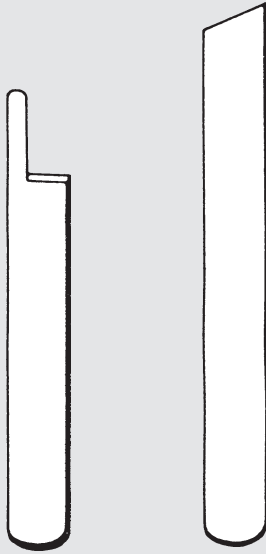

96-705205-05
JABD 816



96-706135-05
JABD 815



96-707786-05
JAB 816 A



JC 816

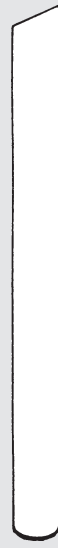

96-706651-05
JA 815



96-705438-05
JAB-A 816

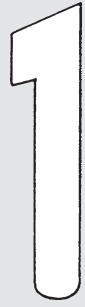

96-705468-05
JAB-A 815

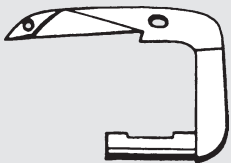

96-702693-05
J 37 L

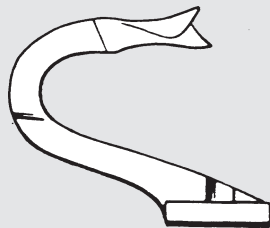

96-702414-05
JLB 37 R

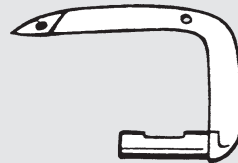

96-702692-05
JC 37 L

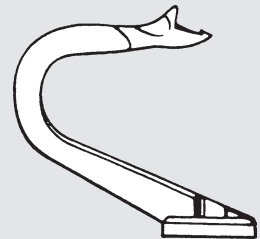

96-702684-05
JG 37 R

4542, 4562

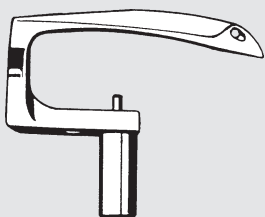

257550-91
09-400401-00

68



96-795104-00



S 1323 usw.



96-720745-05
S 815-8
720745 (CT)

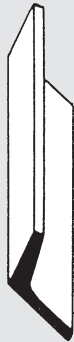

96-720742-05
SH 816-8



96-720744-05
SK 816

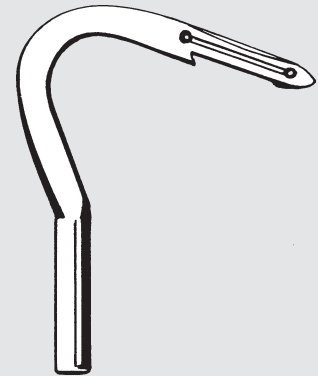

96-720392-05
S 37 BL

AG



CAM 315



CAM 316

Teile für Mauser-Overlock / Safety-Maschinen siehe Pegasus.
Parts for Mauser-Overlock / Safety Machines see Pegasus.
Piezas para Mauser-Overlock / Máquinas de seguridad véase Pegasus.

Mauser-Klasse	=	Pegasus-Klasse
401	=	L 22
500	=	L
504	=	R 53, R 57
2001	=	S 22
2003	=	S 52
2004	=	S 52
2005	=	S 52
2014	=	S 32
2015	=	S 32
2016	=	S 32
4542	=	W 542
4562	=	W 562
4664	=	W 664
4742	=	W 742

Mauser-Klasse	=	Pegasus-Klasse
4762	=	W 762
9622	=	E 22
9622 L	=	E 22 L
9632	=	E 32
9632 L	=	E 32 L
9651	=	E 51
9652	=	E 52
9652 L	=	E 52 L
9654 A	=	E 54
9656	=	E 256
9732	=	ETS 32
9732 L	=	ETS 32 L
9751	=	ETS 51
9752	=	ETS 52



CT 6-90 D

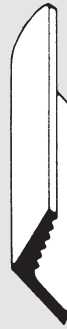

A-90-1

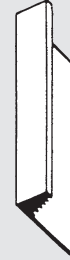

A 90-3



6-91



6-91 E



CT 6-91 E



6-91 C



6-91 H



6-91 K



59



72



DB 130, 189, 199
LS 2-150, 180
LS 190, 210



MF 16 A 0838

LG 2-3370, LS-1280
LS 2-180, LS 2-190, LS 2-210
LS 2-1180, LS 2-1280, LS 2-1380, LS 2-1780
LS 2-2210

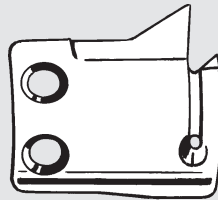

MF 00 A 0834



MF 00 A 0838

DB-199, LS 2-190
PLK-1210, PLK-2520

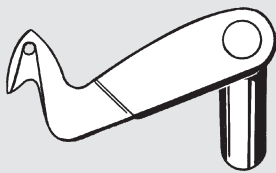

MF 90 B 2838
MF 90 B 0838

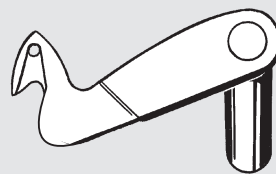

MG 44 B 0838



MF 90 A 0838

109, 303



MS 01 B 0838



MS 01 A 0838

DB 189

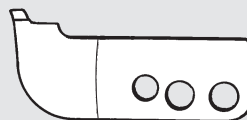

MF 40 A 1835
MF 40 A 2835

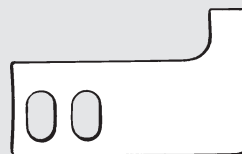

MF 40 A 1834

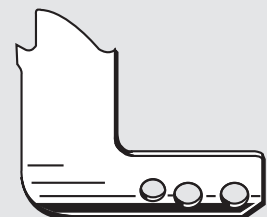

MF 40 A 2180



**LS 2-Series
LT 2-Series
LU 2-Series
LU-Series**



MN 50 A 0838



MN 50 B 0838



MP 41 A 0838



MP 41 B 0838

**DY 359
PLK-2520 A
LY-3310-B1T
LY-3750-B1T
LY2-3710-B1T
LY1-3750-B1T**

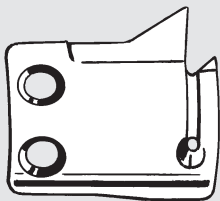

MG 52 A 0834



MG 52 A 0838

339, 349



MG 40 B 0834

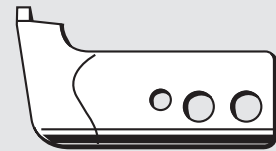

MG 40 B 0835

**PLK-Series
PLK-E-Series
PLK-G-Series**



MS 03 B 0838



MS 14 A 0838
MS 03 A 0838

**LS 2-180 B1T
PLK-1410, 1710
PLK-E 2010R
PLK-E 2516R
PLK-G 5045R**

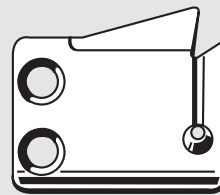

MF 02 A 0834



MS 10 A 0838
MF 02 A 0838



400-100, 405-100, 458-100

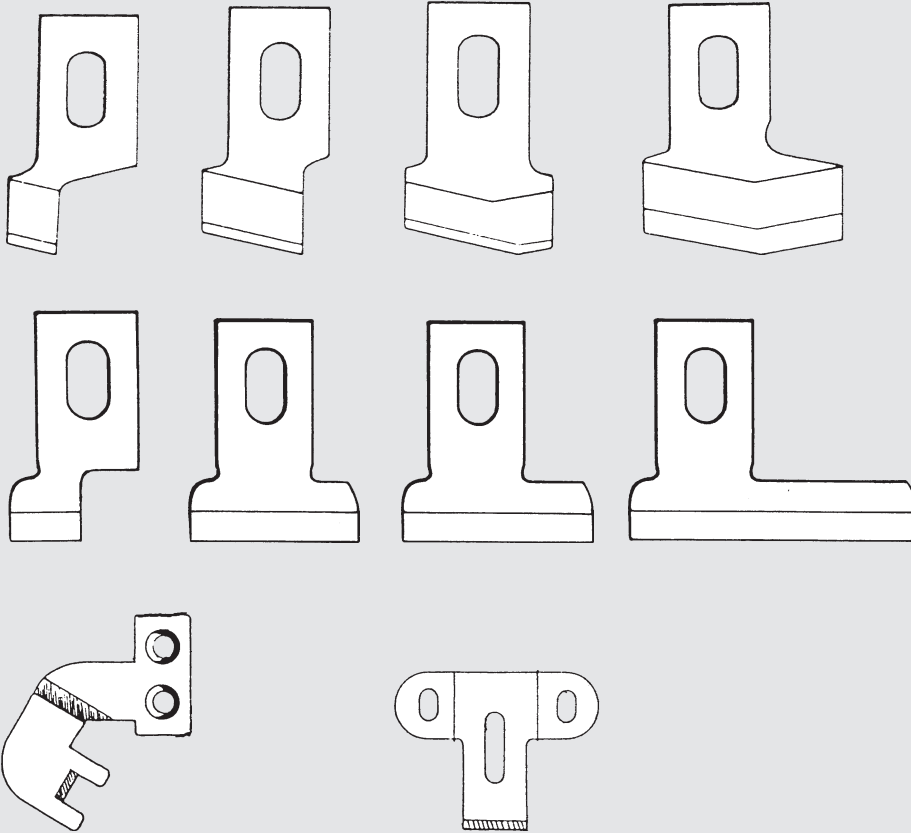

HSS = High speed steel
Acero rápido de alto rendimiento

- = Pfaff-No.
- 996448000 = 20241 - 6,4
- 996449000 = 20241 - 9,5
- 996450000 = 20241 - 11,0
- 996451000 = 20241 - 12,7
- 996451000 = 20241 - 14,0
- 996451000 = 20241 - 16,0
- 996452000 = 20241 - 17,5
- 996452000 = 20241 - 19,0
- 996452000 = 20241 - 20,0
- 996453000 = 20241 - 22,2
- 996454000 = 20241 - 25,4
- 996455000 = 20241 - 28,6
- 996456000 = 20241 - 31,7
- 996456000 = 20241 - 33,3
- 996456000 = 20241 - 36,5
- 996458000 = 20241 - 38,1
- 996458000 = 20241 - 39,7

- 120748 - 6,4
- 120748 - 9,5
- 120748 - 11
- 120748 - 12,7
- 120748 - 14
- 120748 - 16
- 120748 - 17,5
- 120748 - 19
- 120748 - 22,2
- 120748 - 25,4

154851000

154852000

835-261, 263
885-261, 263
UAN 2641 / 2661

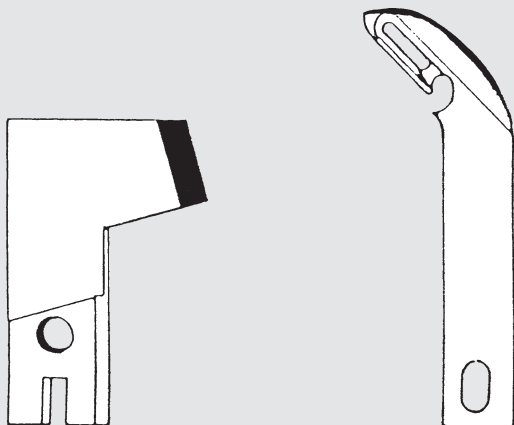

186188202 (CT)

186185007

UAN 1700, 1701

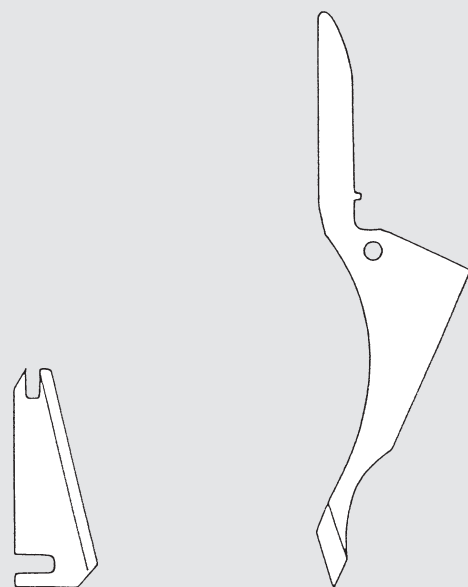

181814003

181812000 (HSS)



DCR 601, 801, 901, 905
E22, E22L, E32, E32L, E51, E52, E52L, E54, E256
ETS32, ETS32L, ETS51, ETS52
EX/EXT 3200, 5100, 5200, 5400 Series

L32, L52
R53, R57
S22, S32, S52
W&G 504, 515

MX 3200, 5200
LX 3200, 5200
M 600, M 700
BL 500, BL 600



202570
323-870-200
09-009052-54

201121 A
323-870-214
09-009050-06 (CT)

205607 (CT)
09-009801-41
links/lefthand/
à la izquierda

205890 (CT)
09-009732-15

202571
323-870-201
09-009052-55

202527 (CT)
323-870-207
09-009070-82

277000 (CT)
09-009846-02

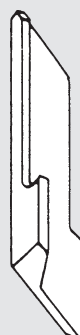
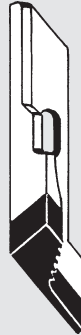
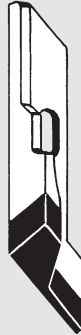
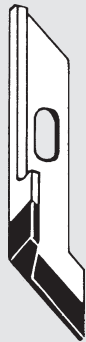

CT 210755
91-179421-01

211771 (CT)
09-009807-78

211662 (CT)
09-009802-00

211662A (CT)
09-009857-11

204835 (CT)
09-009071-09

204152
09-009065-29



202295
323-870-210
09-009-066-42

202572
323-870-202

205609
09-009801-40
links/lefthand/
à la izquierda

202893
323-870-215
09-009819-09 (CT)

201127
323-870-211
09-009054-43
202573
323-870-203
09-009052-57



DCR 601, 801, 901, 905
E22, E22L, E32, E32L, E51, E52, E52L, E54, E256
ETS32, ETS32L, ETS51, ETS52
EX/EXT 3200, 5100, 5200, 5400 Series

L32, L52
R53, R57
S22, S32, S52
W&G 504, 515

MX 3200, 5200
LX 3200, 5200
M 600, M 700
BL 500, BL 600



204161
323-870-213
09-009053-33



204351
323-870-218
09-009606-90 (CT)



204161 A
09-009831-32



211661
09-009803-45



210762
09-009620-39



277009
09-009846-08



208393
09-009842-89



213108
09-009812-97

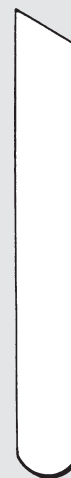

211742
09-009825-62



211788
09-009806-67



202874 (1)
323-810-211
09-009053-31



204062 (2)
323-810-218
09-009054-19



202828 (4)
323-810-224
09-009065-90



204663 (7)
323-810-008
09-009068-07



204990 (12)
323-810-231
09-009603-48

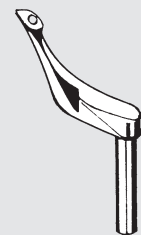

204702 (4)
323-810-009
09-009067-70



DCR 601, 801, 901, 905
E22, E22L, E32, E32L, E51, E52, E52L, E54, E256
ETS32, ETS32L, ETS51, ETS52
EX/EXT 3200, 5100, 5200, 5400 Series

L32, L52
R53, R57
S22, S32, S52
W&G 504, 515

MX 3200, 5200
LX 3200, 5200
M 600, M 700
BL 500, BL 600

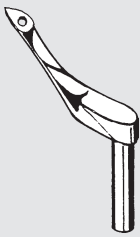

204703 (6)
323-810-010
09-009067-68



204704 (3)
323-810-011
09-009068-98



204705 (5)
323-810-012
09-009067-69

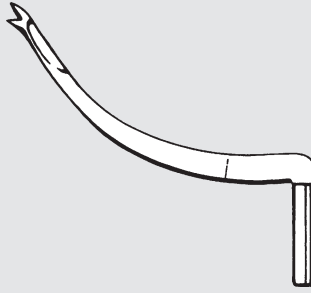

201234 A
323-810-003
09-009050-62

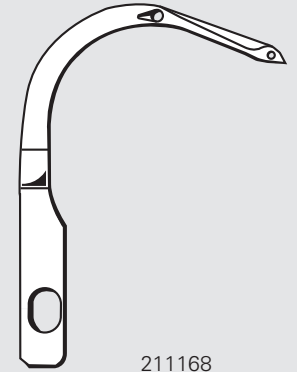

211168

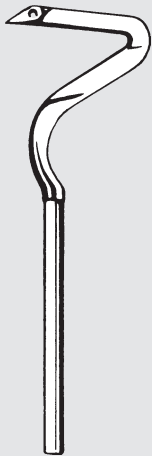

201085 B
323-810-002
09-009049-56

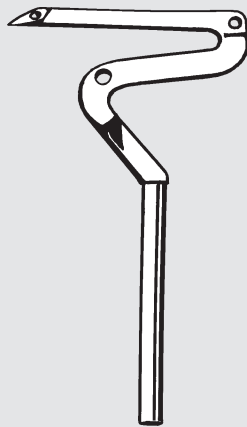

202703
09-009065-89

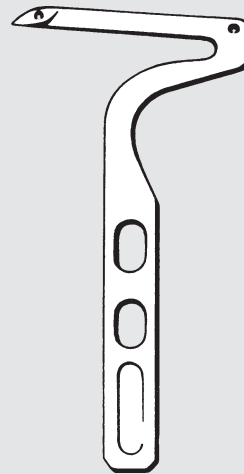

204072
323-810-216
09-009054-20

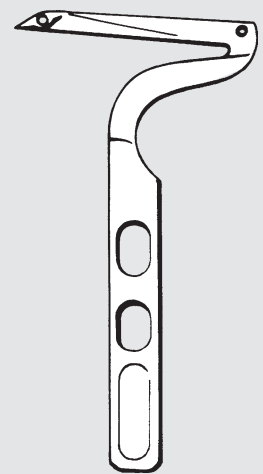

204991
323-810-232
09-009603-49

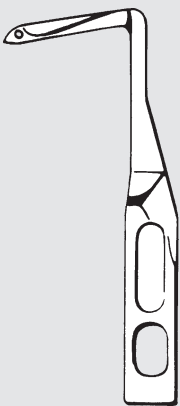

204431
323-810-219
09-009065-26

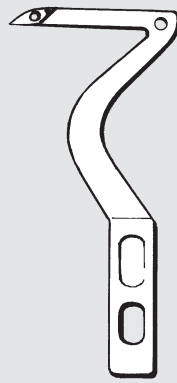

210354
323-810-018
09-009618-12

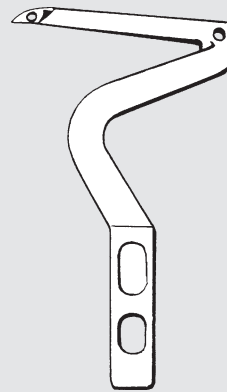

210356
323-810-019
09-009615-99

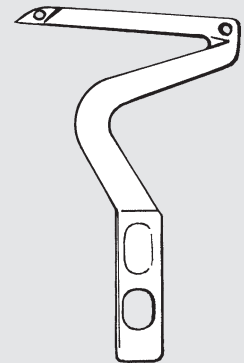

211651
09-009802-29



DCR 601, 801, 901, 905
E22, E22L, E32, E32L, E51, E52, E52L, E54, E256
ETS32, ETS32L, ETS51, ETS52
EX/EXT 3200, 5100, 5200, 5400 Series

L32, L52
R53, R57
S22, S32, S52
W&G 504, 515

MX 3200, 5200
LX 3200, 5200
M 600, M 700
BL 500, BL 600

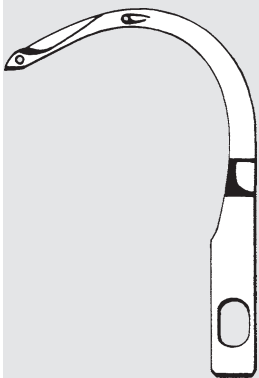

210357
09-009807-47

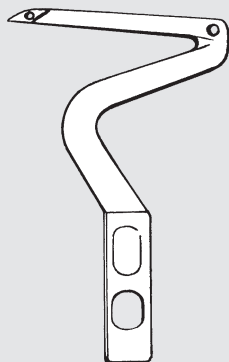

212215
09-009802-28

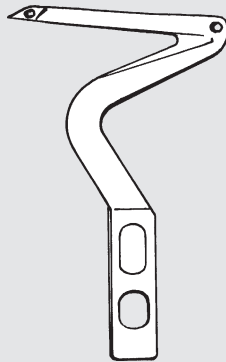

212644
09-009804-51

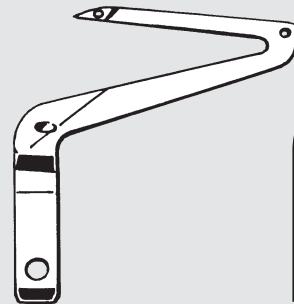

213105
09-009812-96

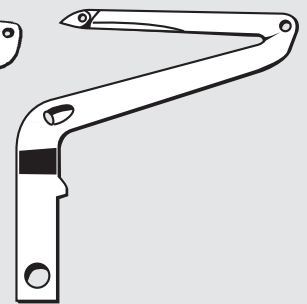

277021



210358 (2)
323-810-021
09-009620-31



210359 (4)
323-810-022
09-009616-01



210360 (6)
323-810-023
09-009618-08



210364 (22)
323-810-025
09-009616-03



210365 (24)
323-810-026
09-009616-04



210366 (26)
323-810-027
09-009620-33



210367 (28)
09-009620-34



210729 (30)
323-810-031
09-009617-97



210730 (32)
09-009617-98



211719 (38)
09-009733-31



210512 (21)
09-009617-06

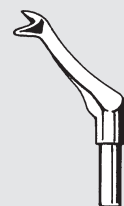

210513 (23)
09-009617-07

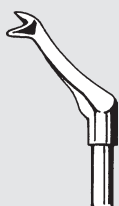

211845 (29)
09-009733-37



212092 (10)
09-009811-92



204949 (11)
09-009833-45



204963 (8)
09-009611-28



204964 (9)
09-009611-29



DCR 601, 801, 901, 905
E22, E22L, E32, E32L, E51, E52, E52L, E54, E256
ETS32, ETS32L, ETS51, ETS52
EX/EXT 3200, 5100, 5200, 5400 Series

L32, L52
R53, R57
S22, S32, S52
W&G 504, 515

MX 3200, 5200
LX 3200, 5200
M 600, M 700
BL 500, BL 600

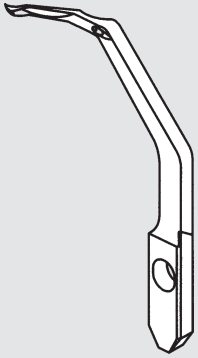

277018
09-009846-18

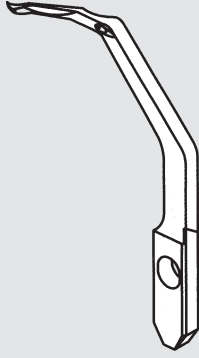

277018 C
09-009846-19

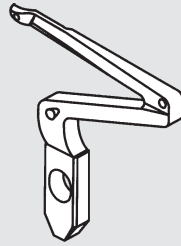

277015
09-009846-14

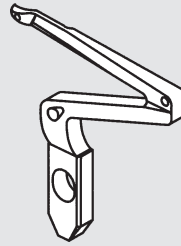

277015 A
09-009846-15

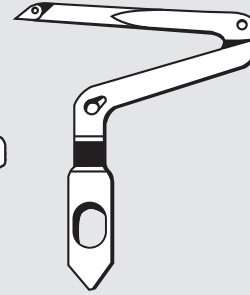

277016 A

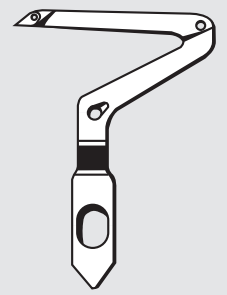

277034



277010 (2)
09-009846-09



277010 A (5)
09-009846-10



277010 B



277011 (3)
09-009846-11



277012



277013



277014 (1)
09-009846-12



277014 A (8)
09-009846-13



277014 B (9)
09-009844-22



277017 (11)
09-009846-17



277019 (12)
09-009846-20



308030 (CT)

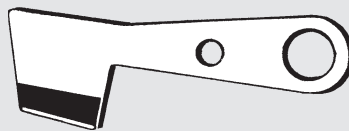

301008
09-009621-65 (CT)

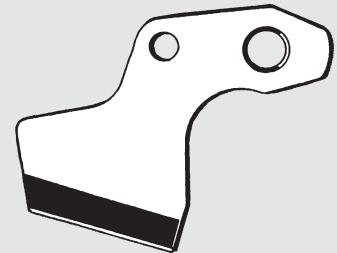

301036
09-009806-73 (CT)

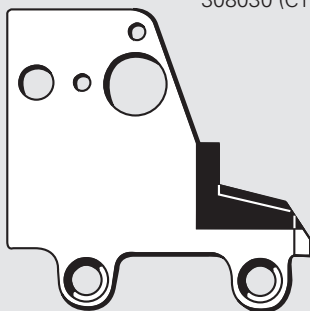

308026-91 (CT)

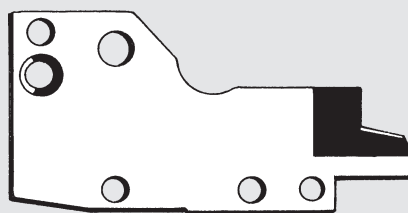

301006
09-009621-64 (CT)

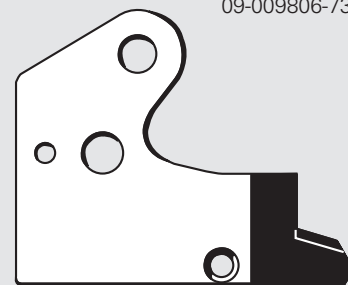

179458-05 (CT)



DCR 601, 801, 901, 905
E22, E22L, E32, E32L, E51, E52, E52L, E54, E256
ETS32, ETS32L, ETS51, ETS52
EX/EXT 3200, 5100, 5200, 5400 Series

L32, L52
R53, R57
S22, S32, S52
W&G 504, 515

MX 3200, 5200
LX 3200, 5200
M 600, M 700
BL 500, BL 600

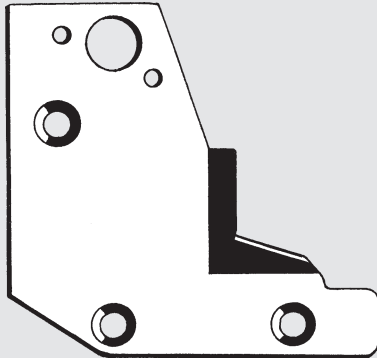

301035
09-009806-72 (CT)



179459-05 (CT)

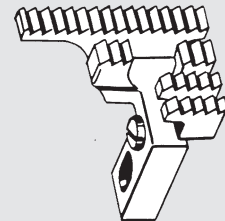

208063
09-009071-19

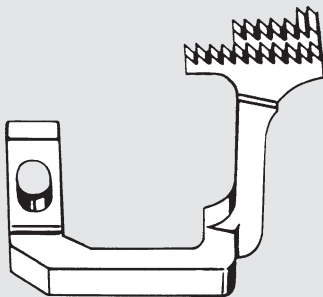

204907
09-009068-97

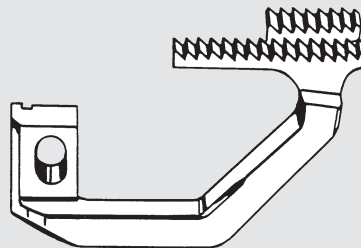

210494
09-009616-98

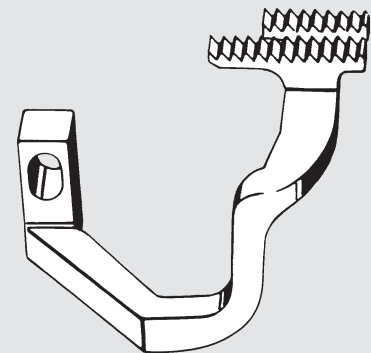

208215
09-009071-27



208338
09-009611-70

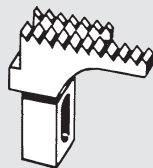

208336
09-009611-68

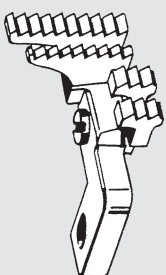

210568
09-009617-26

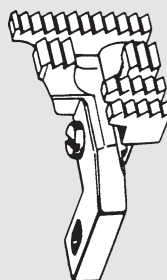

210581
09-009606-75

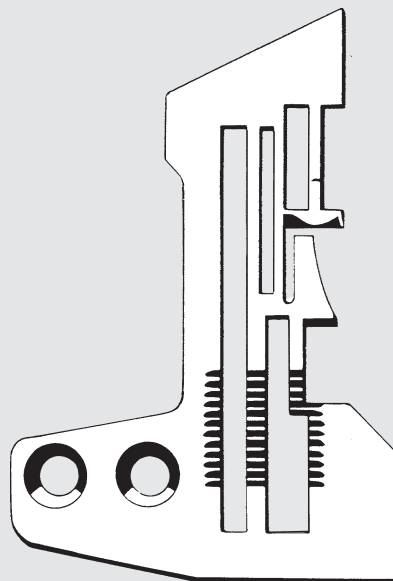

210787
09-009620-45

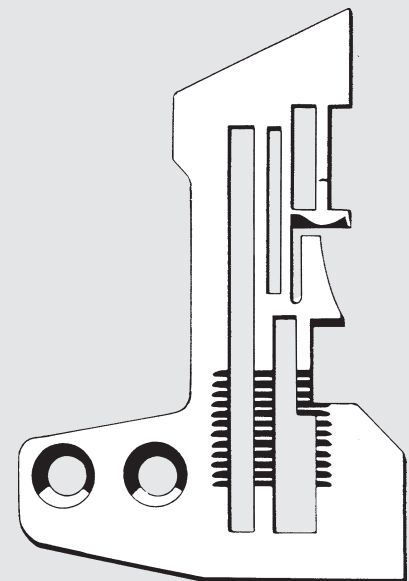

210788
09-009620-46



DCR 601, 801, 901, 905
E22, E22L, E32, E32L, E51, E52, E52L, E54, E256
ETS32, ETS32L, ETS51, ETS52
EX/EXT 3200, 5100, 5200, 5400 Series

L32, L52
R53, R57
S22, S32, S52
W&G 504, 515

MX 3200, 5200
LX 3200, 5200
M 600, M 700
BL 500, BL 600

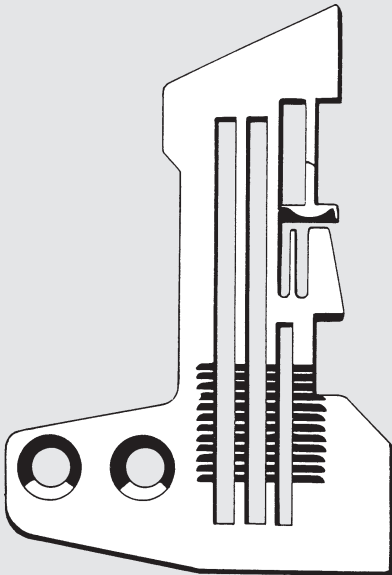

210810
09-009620-66

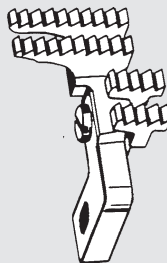

210575
09-009617-33

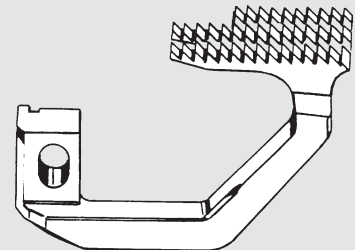

210445
09-009616-58

TM 625

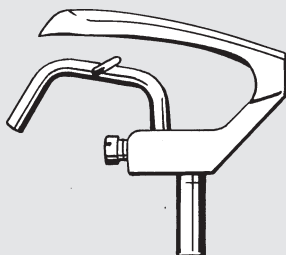

188004

M 732



209685

DCM 203, DCM 220, 230



138559
09-009048-49



137562
09-009048-39



W 280-, 500-, 600-, 700-, 1500-, 2600 Series
WT 200-, 600 Series

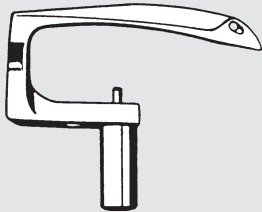

257550-91
09-400401-00

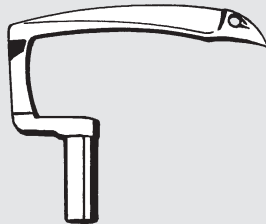

257555
09-009854-48



350018-91
(CT)



350024

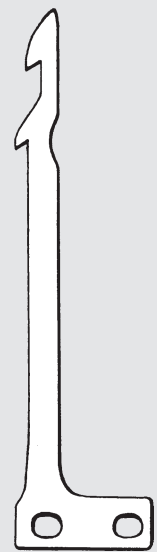

350220
09-009825-63

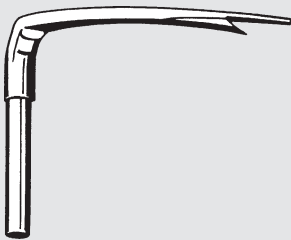

257552
09-400404-00

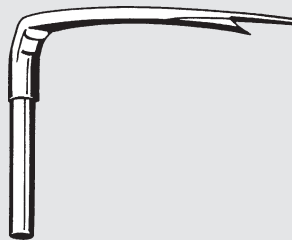

257565
09-009826-28



257566
09-009826-26



350218
09-009825-64



257573 (CT)



257573 A (CT)



306394 (CT)
09-400427-00



257574 (CT)

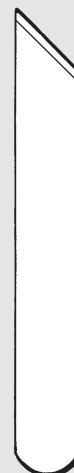

204161
09-009053-33



204161 A
09-009831-32



FS, FV, FW Series

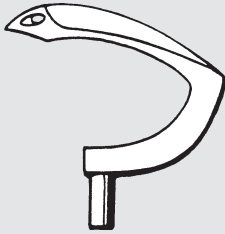

236504 A
09-009852-28



236502 A
09-009852-26

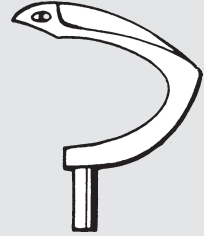

236503 A
09-009852-27

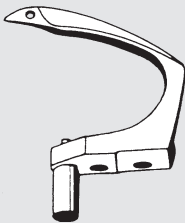

236500 A
09-009854-55

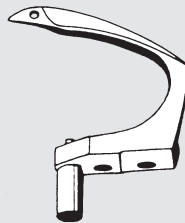

236500
09-009854-54

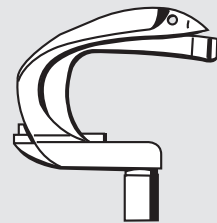

236501 A

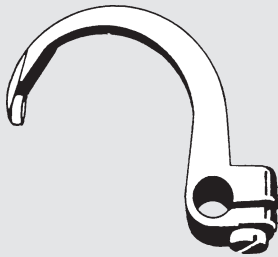

236610



236101
09-009854-49



236609
09-009854-56



236618



236606 SUPER
09-009854-52



236608 SUPER
09-009854-53



133, 134



15323



- 15320-2,0
- 15320-2,5
- 15320-3,0
- 15320-3,5
- 15320-4,0
- 15320-4,5
- 15320-5,0
- CT 15320-3,0
- CT 15320-3,5
- CT 15320-4,0
- CT 15320-4,5
- CT 15320-5,0
- CT 15320-6,0

141, 143



19506 x 5,0



19506 x 7,0



19506 x 9,0

142, 242, 244, 1242, 1243, 1244



113460



10192



91-048908-10-30

91-048909-93/001 (CT)

151, 153



15435 x 4,0
15435 x 5,0



15435 x 7,0

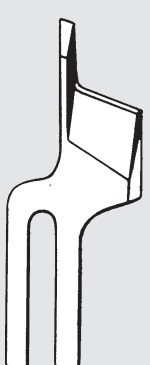

15435 x 9,0

**155, 175, 194, 294,
1293, 1294, 1295, 1296, 3713**



19737 x 5,0



19737 x 7,0



19737 x 9,0



Ersatzteile
aus eigener
Herstellung

**Teile passend für
Pfaff-Nähmaschinen**

**143, 191, 193
471, 474, 491, 493, 571, 574, 591
1471, 1474, 1491, 1493, 1494
1571, 1574, 1591**

**2571, 2574, 2591
3734-2/01, /21
3834-4/11, /21**

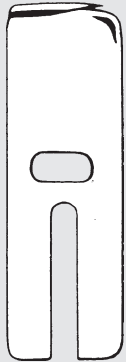

91-011165-04/001 = 2,7
91-011165-04/002 = 3,0

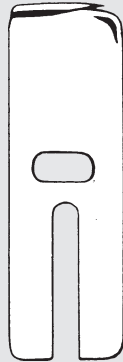

91-011165-04/011 = 2,7 (HSS)
91-011165-04/013 = 3,5 (HSS)

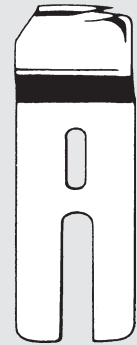

91-011233-04/011 = 2,7 (HSS)

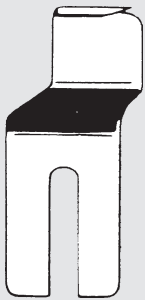

91-011179-04/001 = 2,7
91-011179-04/003 = 3,5



91-011179-04/011 = 2,7 (HSS)



91-011324-04/001 = 2,7
91-011324-04/002 = 3,1
91-011324-04/003 = 3,5

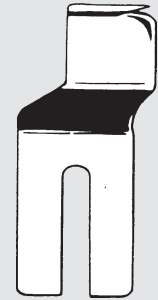

91-011324-04/013 = 3,5 (HSS)



91-119202-04/001



91-119202-04/011 (HSS)



91-119444-04/001



91-119444-04/011 (HSS)

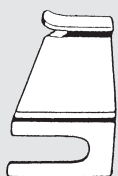

91-119714-05



91-119715-05

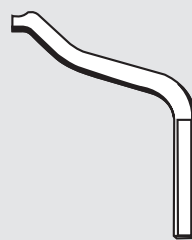

91-156114-05



91-175952-05
Kl. 493-755-743-04



**143, 191, 193
471, 474, 491, 493, 571, 574, 591
1471, 1474, 1491, 1493, 1494
1571, 1574, 1591**

**2571, 2574, 2591
3734-2/01, /21
3834-4/11, /21**

91-119283-01

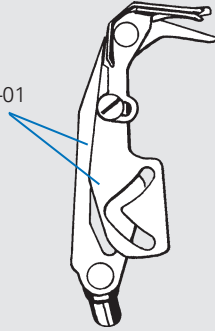

91-119486-91



91-150526-04/001
Bx5,0

91-164673-01

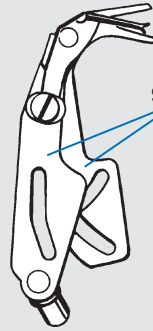

91-164672-91



91-150868-24/002
BN5

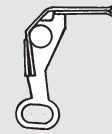

91-119455-05



91-150739-24/001
Bx5,0

194-900, 1293



91-011957-15

333, 335, 337



91-014046-05

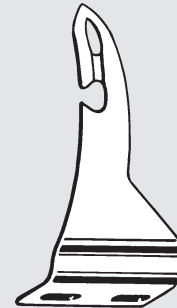

91-165505-05
91-175540-05

441, 442

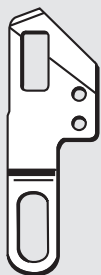

91-173197-15

**5463, 5467
5483, 5487, 5489
3801, 3806, 3811, 3832**



91-172358-05
91-172071-05



91-054896-05

540



91-018147-05



Ersatzteile
aus eigener
Herstellung

**Teile passend für
Pfaff-Nähmaschinen**

**421, 422, 441, 521, 1521, 1525, 1526
1421, 1422, 1425, 1426, 1446
3587, 3588, 3590
3715**

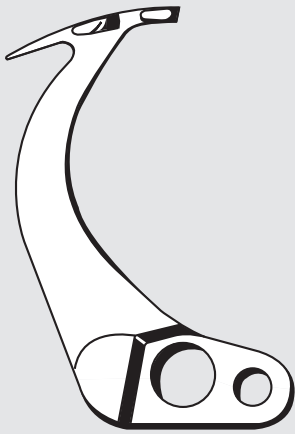

91-164925-05

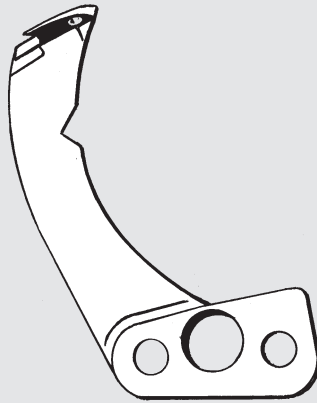

91-176357-05

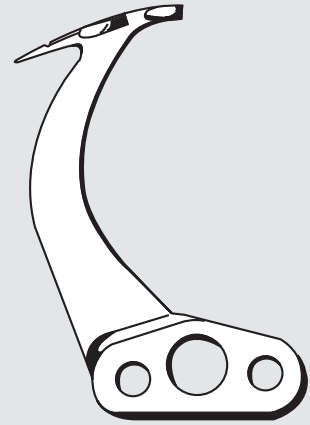

91-176094-05

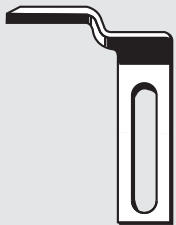

91-176098-05



91-186659-05



91-166700-04/001 =7,0
(HSS)



91-166700-04/002 =9,0
(HSS)



91-166700-04/003 =12,0
(HSS)



91-186661-05



91-166701-04/004 =7,0
(HSS)



91-166701-04/005 =9,0
(HSS)

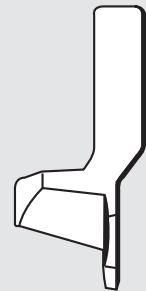

91-166701-04/006 =12,0
(HSS)



3548, 5642, 5645, 5646

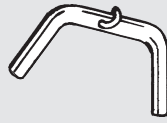

91-172802-01

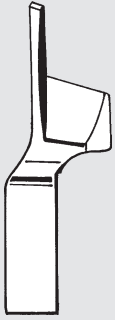

91-173792-05 x 7,0

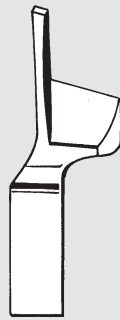

91-173792-05 x 9,0



91-178926-05

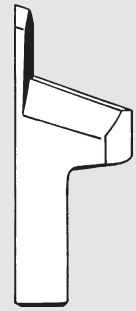

91-177919-05

**418, 437, 438, 439
917, 918, 919, 937, 938, 939
2438, 3568, 3704, 4238
KSM 200
918U, 938U, 939U**

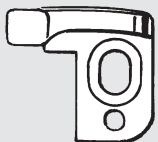

91-167973-05

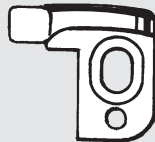

91-167350-01 (CT)



91-168498-15



91-168499-05



91-150166-05
solid carbide
metal solide duro



91-150446-05
solid carbide
metal solide duro

3306, 3307, 3860



91-132558-05



91-110482-05

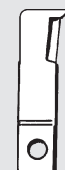

91-180295-05



Ersatzteile
aus eigener
Herstellung

**Teile passend für
Pfaff-Nähmaschinen**

**461, 463, 469
481, 483, 487, 489
1051, 1053
1181, 1183**

**1481, 1483, 1487, 2481, 2483
5463, 5483, 5489
3566, 3568, 3586, 3588
3819, 3822, 3827**

**951, 953
563**

**3511, 3701
3519, 9083**



69595 x 5,0 (HSS)



69595 x 7,0 (HSS)



69595 x 9,0 (HSS)



069596 x 7,0 (CT)
069596 x 9,0 (CT)



169395 x 5,0 (HSS)



169395 x 7,0 (HSS)



CT 169395 x 7,0



169395 x 9,0 (HSS)



CT 169395 x 9,0



91-170440-05 (HSS)



91-170560-04/002 =7,0
(HSS)



91-170560-04/003 =9,0
(HSS)



91-265118-05 (HSS)
KI. 3822-1/24



91-189140-05 (HSS)



91-165629-05 (HSS)



461, 463, 469
481, 483, 487, 489
1051, 1053
1181, 1183



91-171853-15/000

1481, 1483, 1487, 2481, 2483
5463, 5483, 5489
3566, 3568, 3586, 3588
3819, 3822, 3827



91-264338-15



91-165642-15

951, 953
563



91-169239 x 0,8

3511, 3701
3519, 9083



91-169239 x 1,0

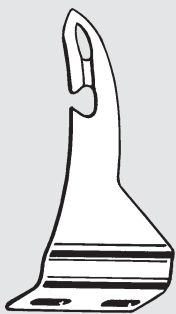

91-165505-05
91-175540-05

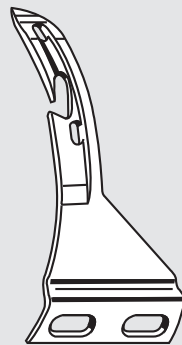

91-165641-05

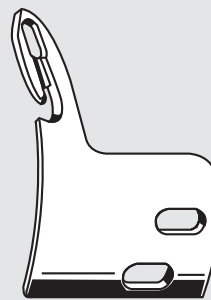

91-262184-05

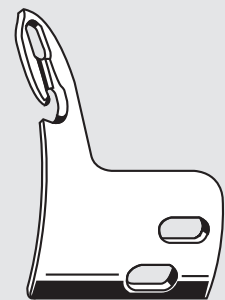

91-264240-05

3334, 3335, 3336, 3337, 3338, 3339



91-182344-05



91-065546-05

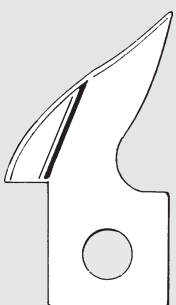

91-022453-05
91-022097-05

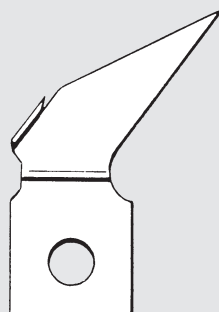

91-022096-05
91-132168-05



91-130182-05

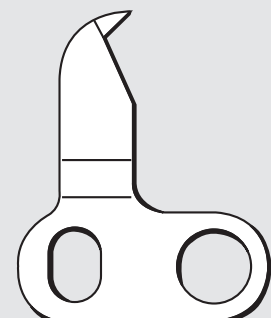

91-130183-05



Ersatzteile
aus eigener
Herstellung

Teile passend für
Pfaff-Nähmaschinen

1114



J101.10.1-2



J101.10.1-7

1163, 9063

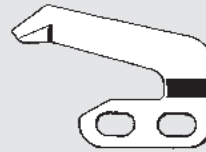

JGR1046-8

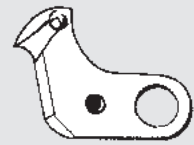

JGR1049/2-8

1122



J211-0060

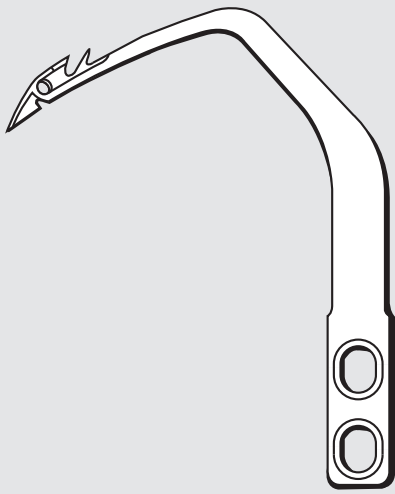

J211.7.7

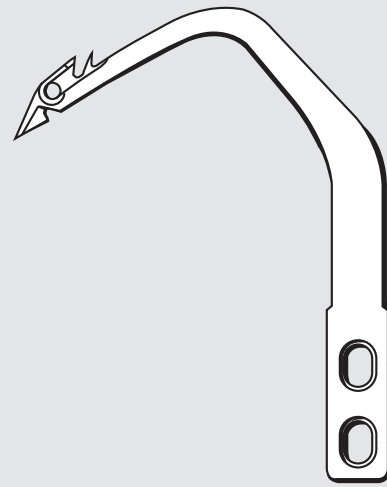

J211-0690

3371



J501GB107

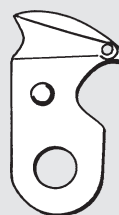

J501BJ133

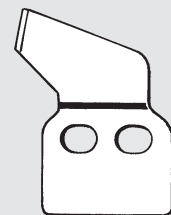

91-181729-05
J501GB160



5704, 5714, 5716, 5742
= Pegasus



J202527 A



J201121 A



J202295

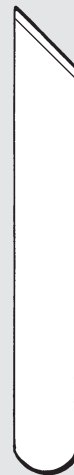

J204161



J208393

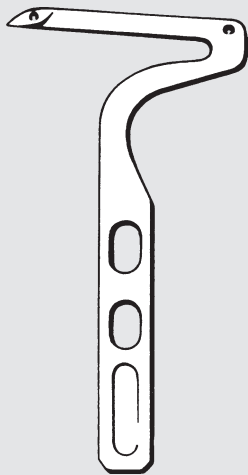

J204072

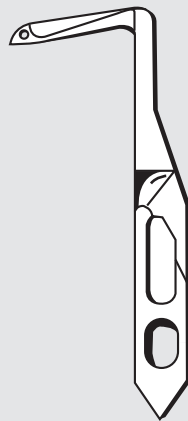

J209685



J204062

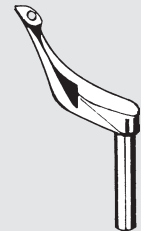

J204702



J204703



J204949

3519

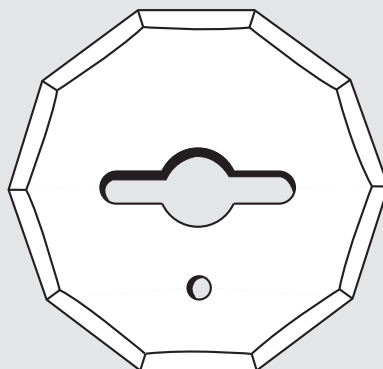

- 99-134505-05
- 99-134505-05 (HSS)
- 99-134505-05 (TIN)



Ersatzteile
aus eigener
Herstellung

Teile passend für
Pfaff-Nähmaschinen

3114, 3116, 3117, 3119, 3527

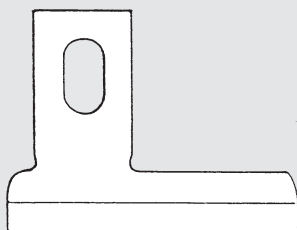
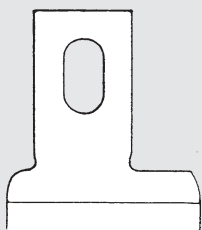
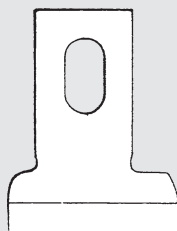
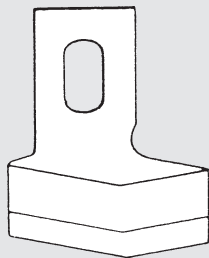
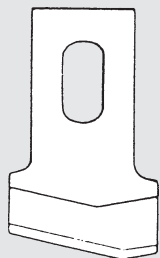
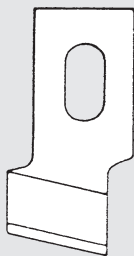
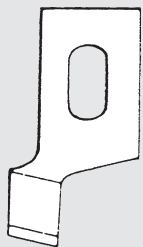

HSS = High speed steel
Acero rápido de
alto redimiento

91-020241 - 6,4	91-020241 - 22,2
91-020241 - 9,5	91-020241 - 25,4
91-020241 - 11,0	91-020241 - 28,6
91-020241 - 12,7	91-020241 - 31,7
91-020241 - 14,0	91-020241 - 33,3
91-020241 - 16,0	91-020241 - 36,5
91-020241 - 17,5	91-020241 - 38,1
91-020241 - 19,0	91-020241 - 39,7
91-020241 - 20,0	

91-120748 - 6,4	= 71-90 1/4
91-120748 - 9,5	= 71-90 3/8
91-120748 - 11,0	= 71-90 7/16
91-120748 - 12,7	= 71-90 1/2
91-120748 - 14,0	= 71-90 9/16
91-120748 - 16,0	= 71-90 5/8
91-120748 - 17,5	= 71-90 11/16
91-120748 - 19,0	= 71-90 3/4
91-120748 - 22,2	= 71-90 7/8
91-120748 - 25,4	= 71-90 1
91-120748 - 28,6	= 71-90 1 1/8

4644, 4661

siehe Pegasus W 664
see Pegasus W664
véase Pegasus W 664



**S 2, S 200, S 2000
S 4000, S 5000**



S 2-51 N
20-0051-1-024
left



S 2-51 R
20-0051-1-024
center



S 2-51 M
20-0051-1-024
right

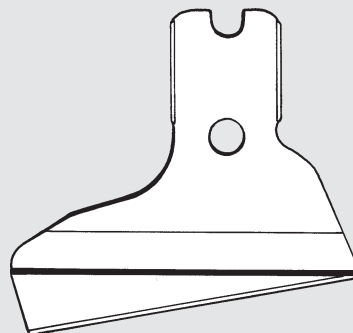

20-0356-0-003 ED

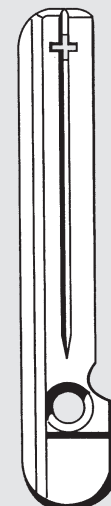

20-0051-0-003



20-0119-2-000
20-0112-0-000
S 119-N



20-0116-3-000
20-0111-0-000
S 116-N 2



20-0094-1-000



20-0094-0-000

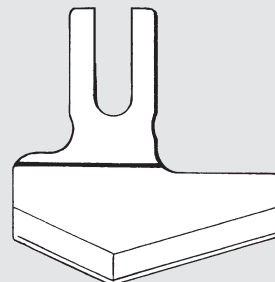
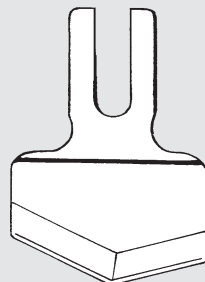
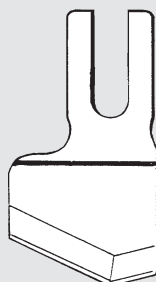
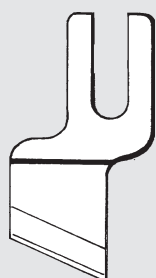

- 23-2356-2-049 1/4
- 23-2356-2-050 3/8
- 23-2356-2-051 7/16
- 23-2356-2-052 1/2
- 23-2356-2-053 9/16
- 23-2356-2-054 5/8
- 23-2356-2-055 3/4
- 23-2356-2-056 7/8
- 23-2356-2-057 1
- 23-2356-2-058 1 1/8
- 23-2356-2-059 1 1/4
- 23-2356-2-060 1 3/8
- 23-2356-2-999 1 1/2



S 101, 104

Looper set USA: 03-5250-0-000

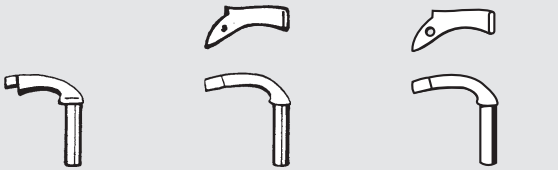

14-4004-0-000
10-4004 USA
14-4005-0-000
10-4005 USA
0,5 mm
14-4005-0-030
0,8 mm

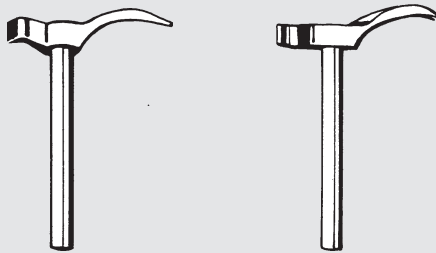

14-4008-1-000
10-4008 USA
14-4009-1-000
10-4009 USA

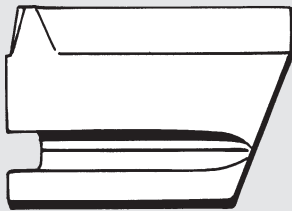

Block/Steel Type A-69-R

- 10-1069-0-001 1/2 - 13
- 10-1069-0-002 5/8 - 16
- 10-1069-0-003 3/4 - 19
- 10-1069-0-004 7/8 - 22
- 10-1069-0-005 1 - 25
- 10-1069-0-006 1 1/8 - 29
- 10-1069-0-007 1 1/4 - 32
- 10-1069-0-008 1 3/8 - 35
- 10-1069-0-009 1 1/2 - 38

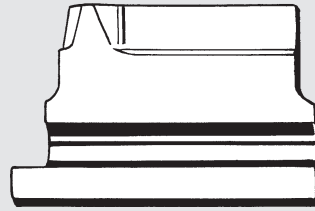

Block/Steel Type A-69-B

- 10-1069-0-073 1/2 - 13
- 10-1069-0-074 5/8 - 16
- 10-1069-0-075 3/4 - 19
- 10-1069-0-076 7/8 - 22
- 10-1069-0-077 1 - 25
- 10-1069-0-079 1 1/4 - 32
- 10-1069-0-080 1 3/8 - 35
- 10-1069-0-081 1 1/2 - 38

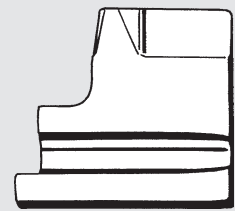

Block/Steel Cord Trim

- 10-1069-0-020 5/8 - 16
- 10-1069-0-021 3/4 - 19
- 10-1069-0-022 7/8 - 22



14-1197-1-000

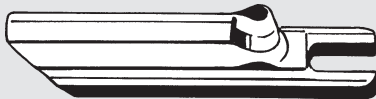

10-3072-0-024 1 1/4 C72-RJRE
10-3072-0-059 5/8 CT-RE
10-3072-0-060 3/4 CT-RE
10-3072-0-067 5/8 CT-LE
10-3072-0-023 1 1/4 NE (ohne Auge/without eye)

10-3072-0-014
Weitere Abmessungen auf Anfrage
Further dimensions on request
Otras medidas de ser demandadas

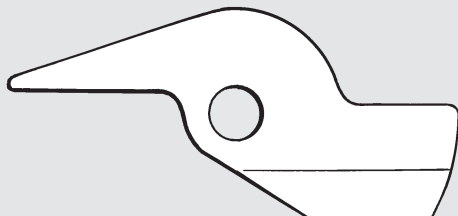
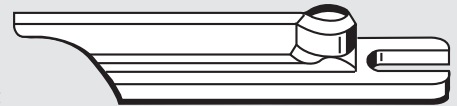

10-2206-1-000

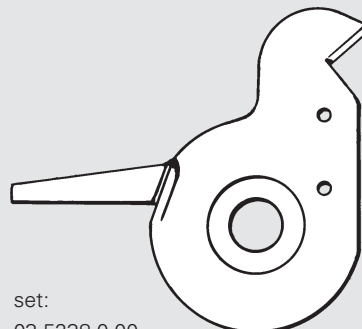

set:
03-5238-0-00

10-2207-1-000

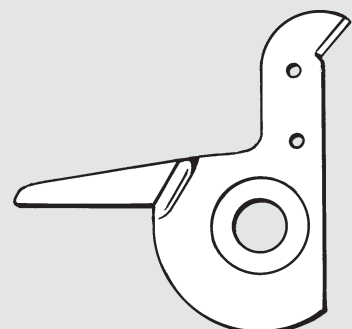

10-2207-1-600



**S 100 (Global BH 770), S 111
S 211, S 311 XL 21**



17-0069-4-048
Global:
522-080-694048

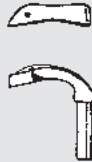

17-0069-4-049
Global:
522-080-694049



17-0069-4-019

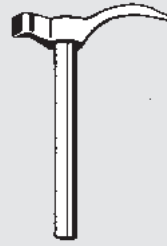

17-0004-9-894
Global:
522-980-049894

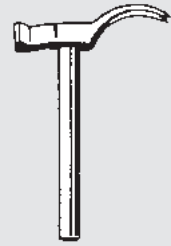

17-0004-9-895
Global:
522-980-049895

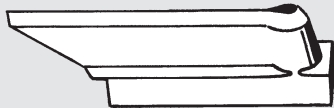

17-0064-5-864 (CA)
Global:
522-080-645864

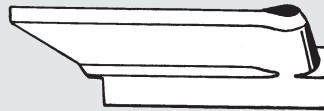

17-0064-5-950 (CB)
Global:
522-080-645950



17-0087-0-204

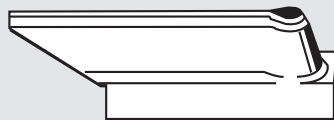

19-0087-0-432

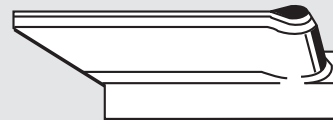

19-0087-0-434



17-0064-5-849 16 mm
17-0064-5-852 22 mm
17-0064-5-854 26 mm
17-0064-5-855 28 mm
17-0064-5-856 32 mm
17-0064-5-858 38 mm

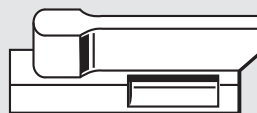

19-0064-5-855

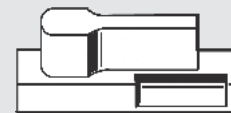

19-0064-5-952



31, 32, 36, 38, 42, 46, 47, 48
Lockwelt 2000, 3000, 6000, 7000

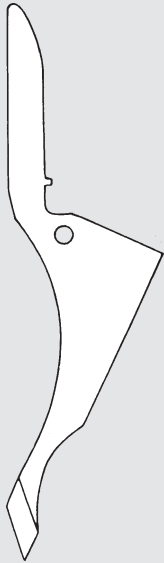

40-0012-2-045 (HSS)
P 12 XN 1
Kl. 42

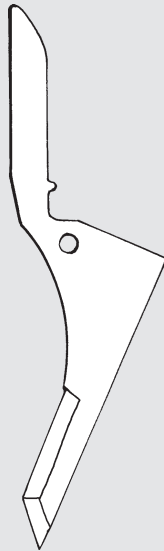

42-0012-0-000 (HSS)
P 12 XN 1-SP
Kl. 42



40-0127-2-000
P 127
40-0127-0-001 (TIN)

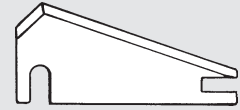

46-1001-4-136
P 127 Special
0,6 mm HSS

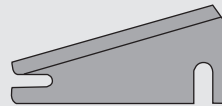

46-1001-5-487
Ceramic
Kl. 36, 38, 46, 47

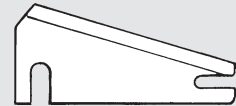

46-1004-9-073
Kl. 36, 38, 46, 47



32-2019-1-000
Kl. S32



46-1125-5-000
Kl. 36, S46, 47



46-1001-5-289



40-0057-6-000



40-0058-5-000



48-1125-5-594 (CT)
Kl. 38, 46, 47, 48



46-1125-5-581
Kl. 38



48-1125-5-721
Kl. 48



67-2462-0-553

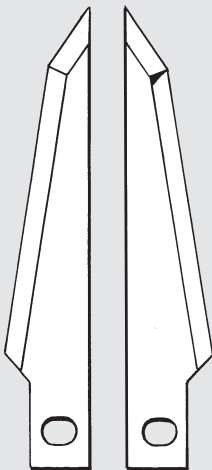

32-2047-1-001 32-2047-1-002
67-2047-1-001 67-2047-1-002
32-2047-1-050
Kl. S 32

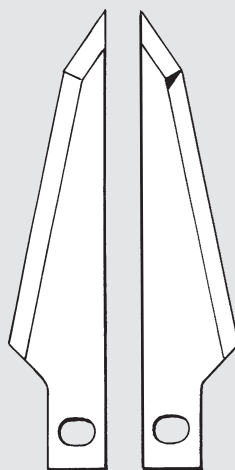

32-2048-1-001 32-2048-1-002
67-2048-1-001 67-2048-1-002
32-2048-1-050
Kl. S 32

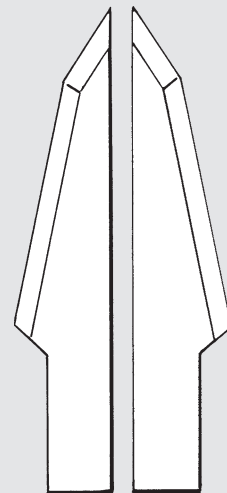

68-0052-0-012

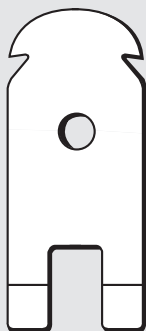

68-0050-0-012



DVN

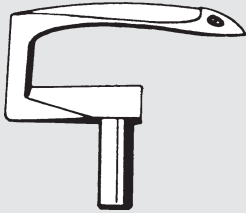

10528

DTN

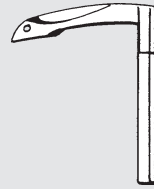

10083



10204



27, 28, 29, 227, 228, 229, 327, 328, 329, 527, 529
627, 629, 637, 639, Orion
Omnitex
Vega



202142-0-10
209348-0-10
270-112



207000-2-00 (CT)
209347-0-00 (CT)



202143-0-10
209350-0-10
270-112/1



203066-0-10
279-112



207006-2-00 (CT)



202145-0-10
270-113

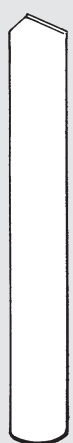

207011-0-00



202146-0-11
270-113/1



207015-2-00 (CT)



207024-2-00 (CT)



207017-2-00 (CT)



209593-0-00



203010-0-10
209358-0-10
277-112



207002-2-00 (CT)
209357-2-00 (CT)



920780-0-10



**27, 28, 29, 227, 228, 229, 327, 328, 329, 527, 529
627, 629, 637, 639, Orion
Omnitex
Vega**



202932-0-10
209356-0-10
279-B-112



207001-2-00 (CT)
209355-2-00 (CT)



203012-0-10
277-113
27.77-113



207016-2-00 (CT)

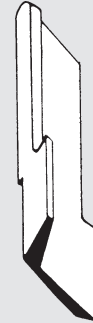

203783-0-10
209352-0-10
27.77-1121

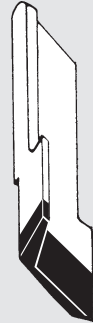

207003-2-00 (CT)
209351-2-00 (CT)

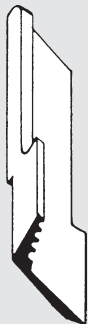

203759-0-10
209354-0-10
27.77-112

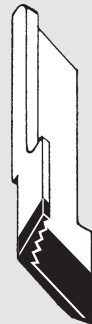

207004-2-00 (CT)
209353-2-00 (CT)

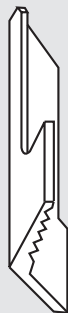

209341-0-10



209342-2-10 (CT)



209340-2-10 (CT)



209425-2-01 (CT)



204693-0-11
290-113 SP (1 mm)



207020-2-01 (CT)



207651-0-00
(1,5 mm)



204693-0-11 BAK
Ceramic



209426-2-00 (CT)



205151-0-00



27, 28, 29, 227, 228, 229, 327, 328, 329, 527, 529
627, 629, 637, 639, Orion
Omnitex
Vega



211424-2-00 (CT)



208011-0-01



206208-0-00
kleines Öhr
small eye
Agujero pequeño



206209-0-00
großes Öhr
large eye
Agujero grande



204021-0-10
27.277-074
großes Öhr
large eye
Agujero grande



204033-0-10
27.277-0745
kleines Öhr
small eye
Agujero pequeño



204022-0-10



202092-0-11
270-D-074-1

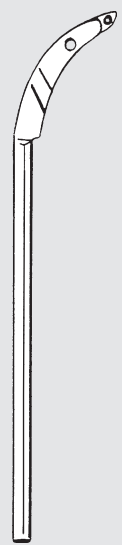

206512-0-02

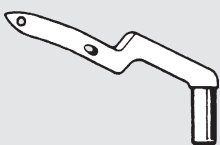

209213-0-00
großes Öhr
large eye
Agujero grande

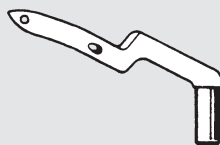

209223-0-00
großes Öhr
large eye
Agujero grande

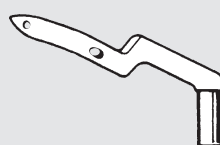

209248-0-00
kleines Öhr
small eye
Agujero pequeño

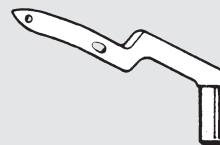

209249-0-00
kleines Öhr
small eye
Agujero pequeño

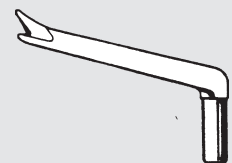

209247-0-00



27, 28, 29, 227, 228, 229, 327, 328, 329, 527, 529
627, 629, 637, 639, Orion
Omnitex, Vega

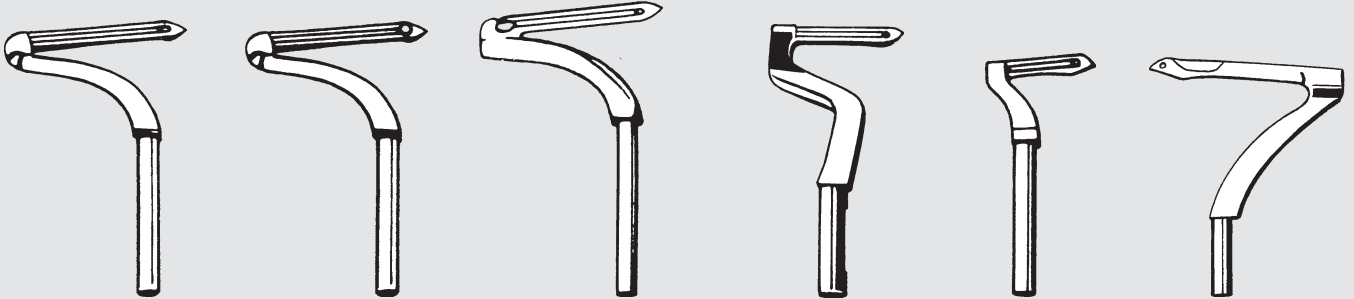

202094-0-13
270-075
kleines Öhr
small eye
Agujero pequeño

202095-0-13
270-075/2
großes Öhr
large eye
Agujero grande

202413-0-13
270-075/1

207722-0-01

204676-0-11
290-075/2

206048-0-13

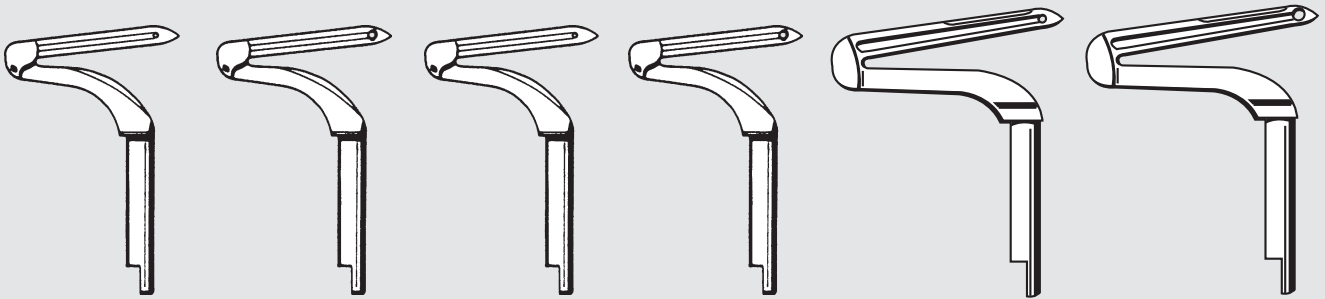

209264-0-00
kleines Öhr
small eye
Agujero pequeño

209265-0-00
großes Öhr
large eye
Agujero grande

209266-0-00

209267-0-00

211266-0-00
kleines Öhr
small eye
Agujero pequeño

211267-0-00
großes Öhr
large eye
Agujero grande

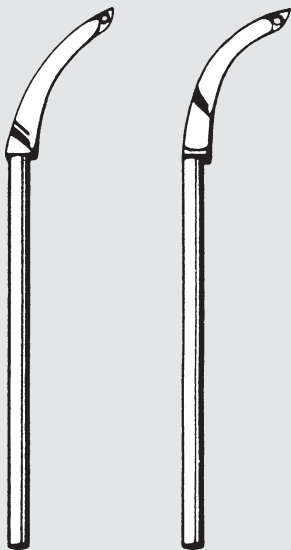

203005-0-10
277-074

203755-0-10
207208-0-00
2777-074



209261-0-00



211248-0-00
kleines Öhr
small eye
Agujero pequeño

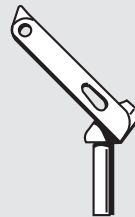

211249-0-00
großes Öhr
large eye
Agujero grande



207995-0-00



207996-0-00



27, 28, 29, 227, 228, 229, 327, 328, 329, 527, 529
627, 629, 637, 639, Orion
Omnitex

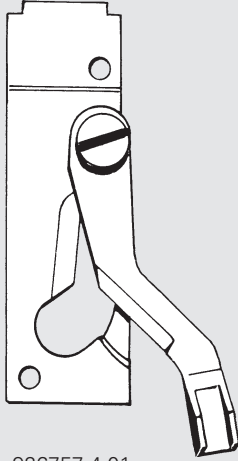

926757-4-01



926753-2-01 (CT)



926756-2-01 (CT)



926758-0-01



923918-0-01



923919-0-01

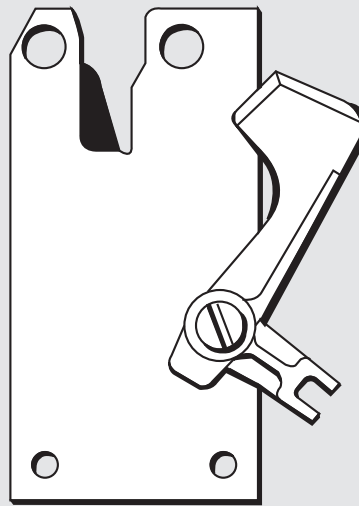

928533-4-01

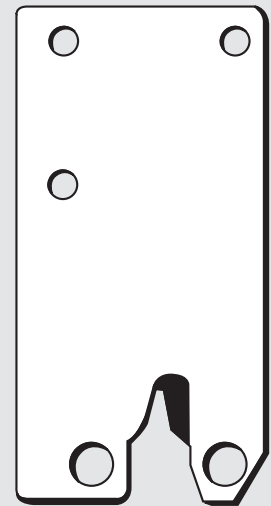

928531-2-00 (CT)



926752-4-00

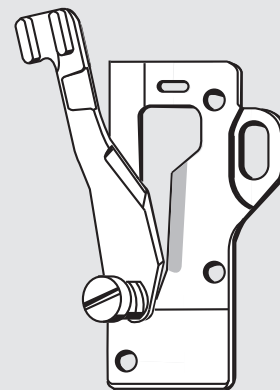

925891-4-00



27, 28, 29, 227, 228, 229, 327, 328, 329, 527, 529
627, 629, 637, 639, Orion
Omnitex

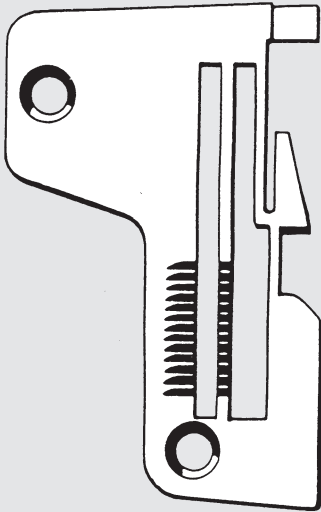

202148-0-10
270-114

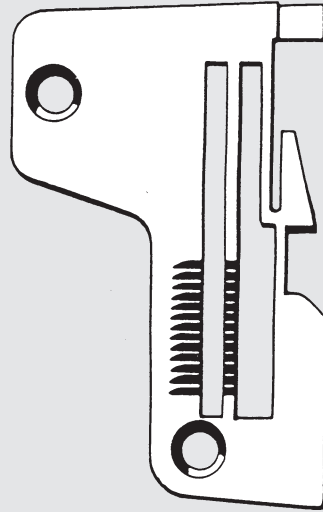

202504-0-10
270-1141

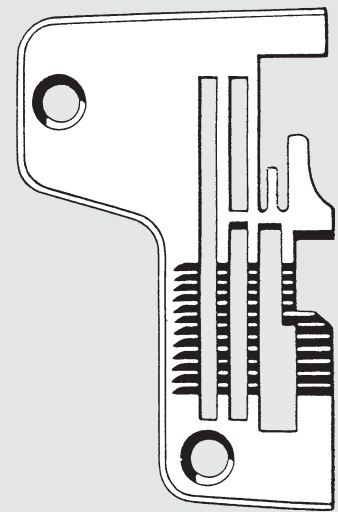

204026-0-10
27-277-114

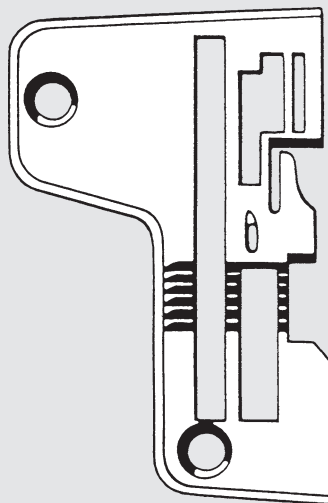

204695-0-11
290-114/1

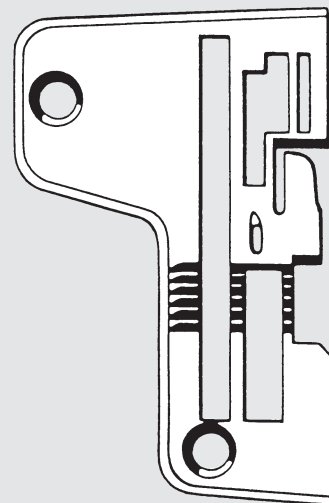

204809-0-00



**21 und 24 Stella
25 und 26 Stella**



200271-0-10
1112
CT 200271-0-10



200274-0-10
1113
CT 200274-0-10



200403-0-10
2112



CT 200404-0-10

427, 429

siehe/see/véase
Siruba

**63, 64, 65, 155, 261, 262, 263, 264 Sirio
73
91, 93, 94 MIZAR**

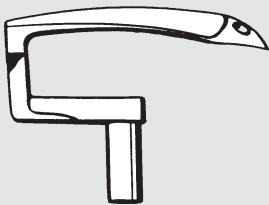

302057-0-13
633-075/2

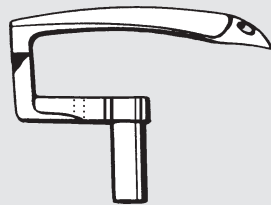

312057-0-00

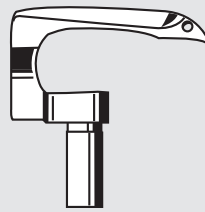

303419-0-12

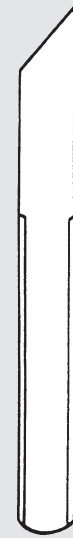

302808-0-10
63.78-113



315507-0-00

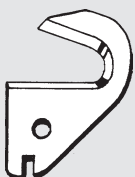

303012-0-10



302807-0-10
63.78-112



305671-2-00 (CT)



315506-2-00 (CT)



63, 64, 65, 155, 261, 262, 263, 264 Sirio
73
91, 93, 94 MIZAR



318735-0-00



318792-2-00 (CT)



318791-2-00 (CT)

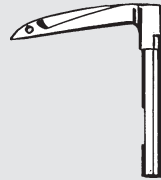

304186-0-13
Kl. 264-22-4ML-01



101572-0-12



318794-2-00 (CT)

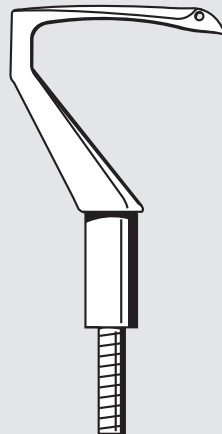

315863-2-02

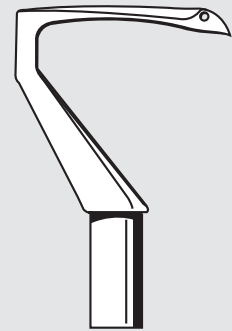

321128-0-10
F 63-45-3 MD-05

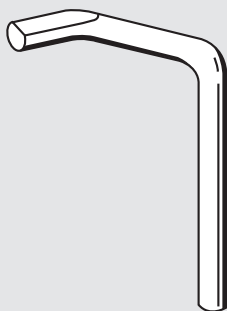

315805-0-00

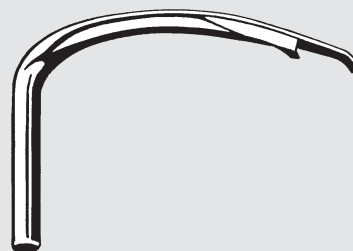

319093-0-00

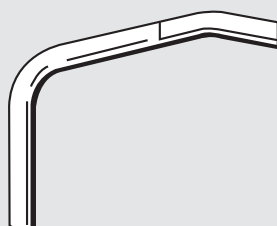

308142-0-00

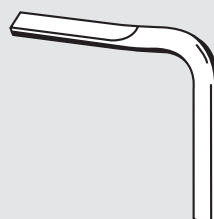

321164-0-00



63, 64, 65, 155, 261, 262, 263, 264 Sirio
73
91, 93, 94 MIZAR

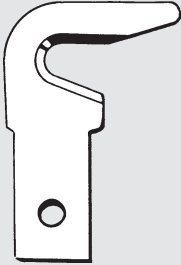

306223-0-10

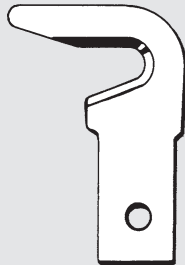

306224-0-10



306234-0-00



306235-0-00

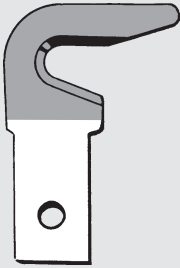

306286-2-00 (CT)

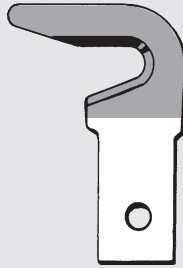

306285-2-00 (CT)



306284-2-00 (CT)



306283-2-00 (CT)

171, 177



924670-0-20



924638-0-10



944422-0-00



933185-0-00



933201-0-00



933186-0-00



183 - 00 - 4 MR 04 - 6,0 mm



350453-0-00



350452-0-00

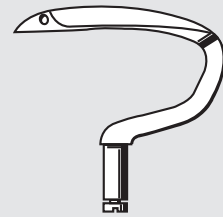

350145-2-11

183 - 00 - 4 MR 01 - 5,6 mm



350069-0-00



350183-0-00

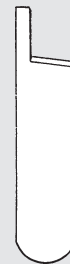

350107-0-00

184

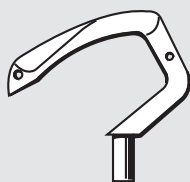

351161-0-10

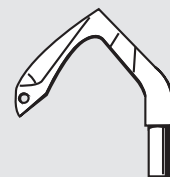

351163-0-10



14 U

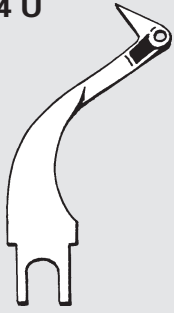

410262

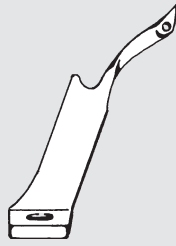

410434

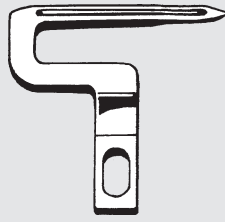

410452

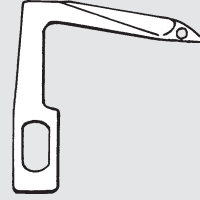

412553

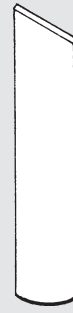

410295



412585

47 W, 51 W, 52 W, 52 K
104 W, 110 W, 136 W, 236 G, 236 U, 236 W

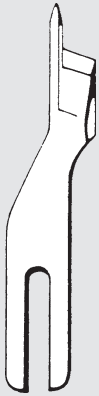

241574 (HSS)

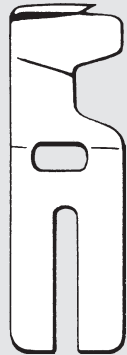

238548



233934

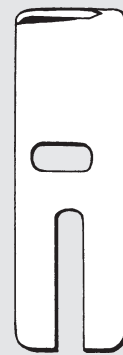

238508

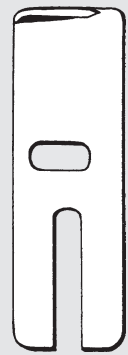

238508 (HSS)

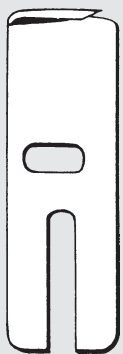

238543

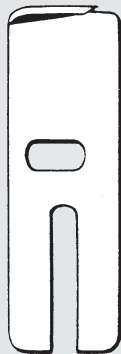

238546



8061 A-3,1

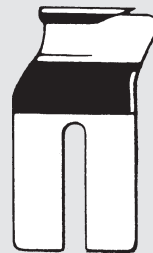

249191-3,1



249191 (HSS)

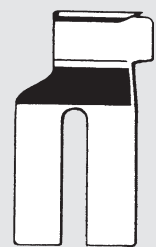

263735

261-U

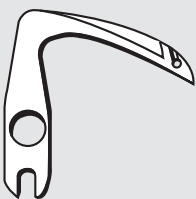

32820

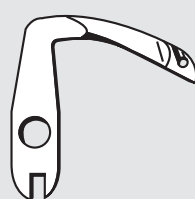

32821

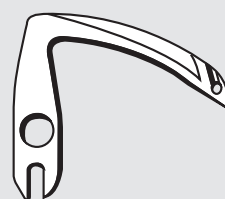

32823

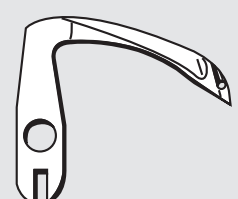

32824



71-1, 3, 5, 6, 11, 12, 13, 30, 31, 32, 34, 35, 40, 42, 45, 101, 107
271-K 11, -K 13
371, 471, 1371 A

HSS = High speed steel
Acero rápido de
alto rendimiento

23443 - 23459:

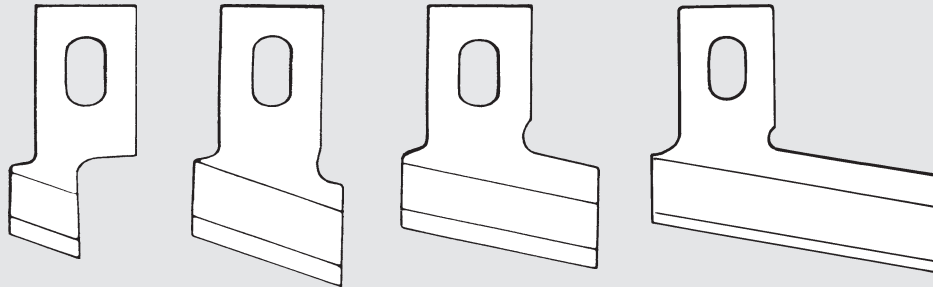

71 1/8	71 13/16
71 1/4	71 7/8
71 5/16	71 15/16
71 3/8	71 1
71 7/16	71 1 1/16
71 1/2	71 1 1/8
71 9/16	71 1 3/16
71 5/8	71 1 1/4
71 11/16	71 1 3/8
71 3/4	71 1 1/2

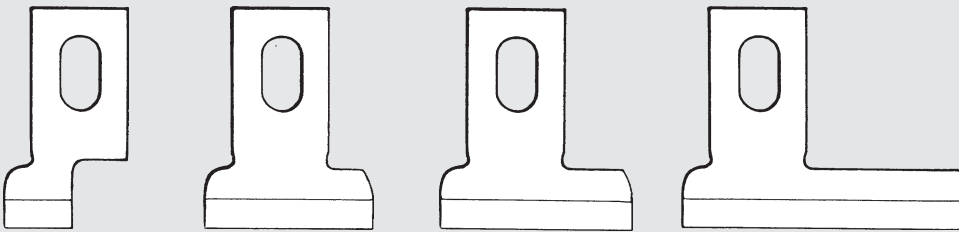

71-90 1/8	71-90 11/16
71-90 1/4	71-90 3/4
71-90 5/16	71-90 13/16
71-90 3/8	71-90 7/8
71-90 7/16	71-90 15/16
71-90 1/2	71-90 1
71-90 9/16	71-90 1 1/8
71-90 5/8	71-90 1 1/4

81



42305
CT 42305



42309
CT 42309

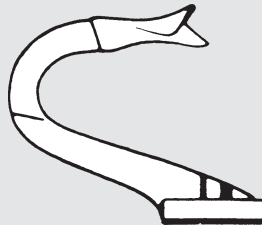

42072

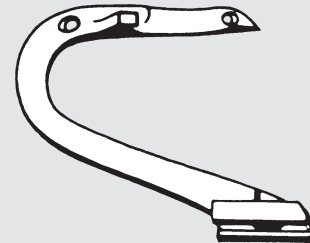

42220

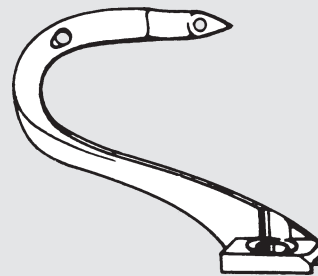

42239

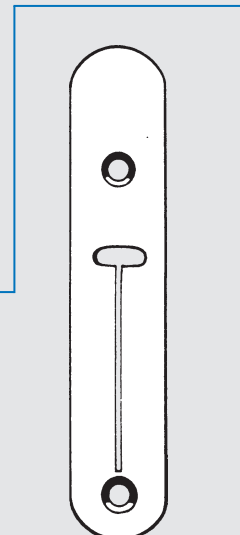

39608
Kl. 71-30

71, 271 K



40048
Kl. 71-30



39609
Kl. 71-30



39867
Kl. 71-48/71-112

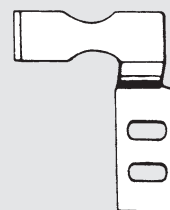

40035
271926



96, 451 K 11
245, 251



147211
276489 (CT)



5730, 142032, 52131
5730 3/32

175, 375
Consew 260, 261



175085



175547

246 K, 460, 990



164308



CT 164308



164550

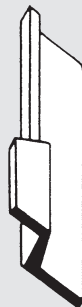

164026

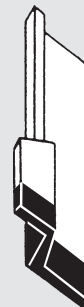

CT 164026



164556



CT 164556



82264



CT 82264



107797



164037



164728
164233
164552

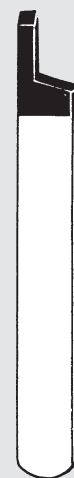

164809 (CT)



164813 (CT)



246 K, 460, 990



164045



164252



164375



164619

68, 69, 269 W, 270

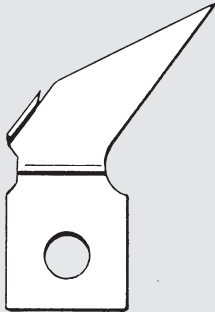

55459



55458



239372



239367

281



785780-001



299 U

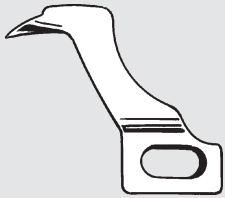

548231

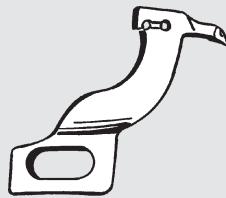

548232

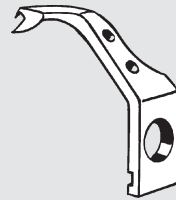

548207

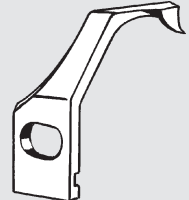

548205

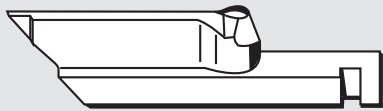

544599

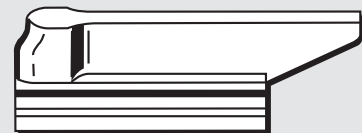

548762 1/2"

548763 5/8"

548764 3/4"

548765 7/8"

548766 1"

548767 1 1/8"

548768 1 1/4"

548769 1 3/8"

548770 1 1/2"

548771 1 5/8"

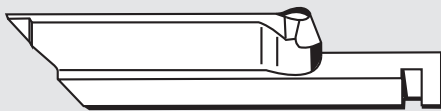

548886

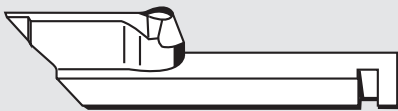

548935

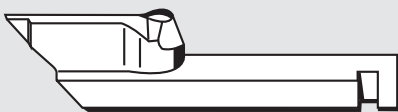

548936

300 U, 300 W, 302 U, 320 W

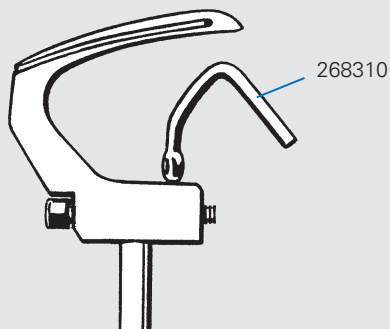

268382
281208

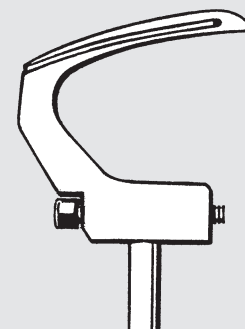

268380



369

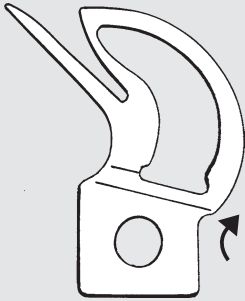

239715

375 B

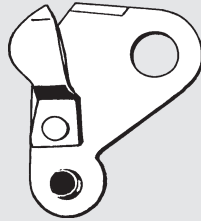

373537



373539

400 W 11



270616



270619

491 D, 591 D, 591 E, 601 D

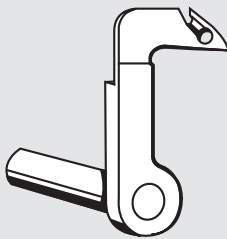

414030

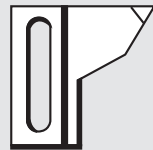

414029



540741

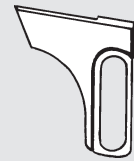

540760

660 AX 2

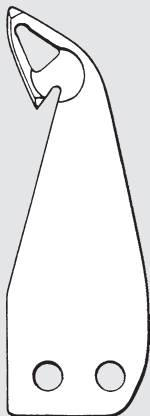

GU 3605
Peschke Nr. 19



GU 3606
Peschke Nr. 18

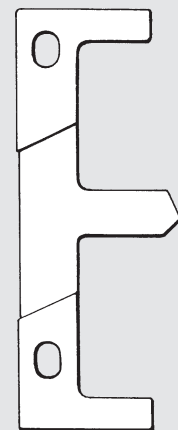

107519



**1831 U, 1832 U, 1842 U
(= Kingtex SH 6000)**



377462 (CT)
6031314 C 500

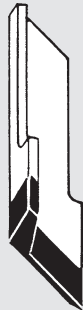

344559 (CT)



377465 (CT)



377559 (CT)
G 6050113 C 500 (CT)



377443
6031218 P 700



377560
G 6050114 P 700

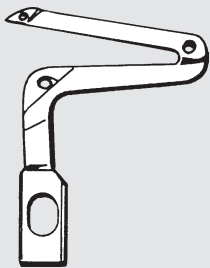

377602
LL 603884

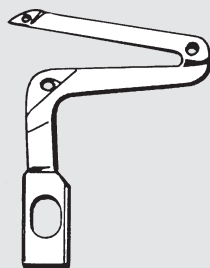

377640
LL 604885

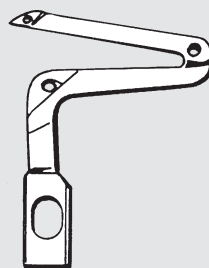

377641
LL 604884
LL 600884

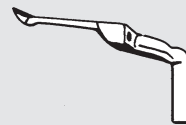

377600 (A)
UL 603880
UL 600880

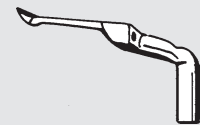

377601 (C)
UL 603886
UL 600886

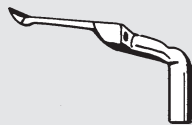

377740 (B)
UL 603881
UL 600881

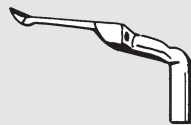

377638 (D)
UL 604883
UL 600883

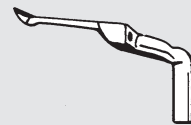

377639 (F)
GUL 604152

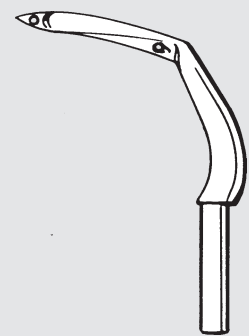

UL 605294

695 = Union Kl. 39500
698 = Union Kl. 39800

801 U = Brother Kl. B 561
802 U = Brother Kl. B 571
812 U = Brother Kl. B 581
831 U = Brother Kl. B 511

832 U = Brother Kl. B 531
842 U = Brother Kl. B 551
881 = Brother
882 = Brother
892 = Brother



727, 737, 747, 757
700 H, 700 F, 700 FS
700 FX



KR 35



KR 55



KR 23 (CT)



KR-23 A (CT)



K-23 C (CT)

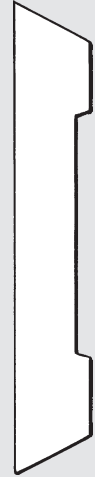

KR-35 C

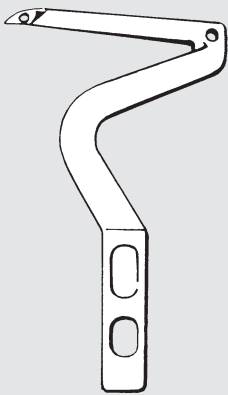

KL 25

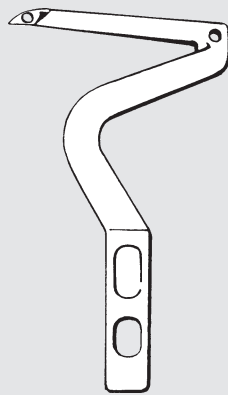

KL 25 A

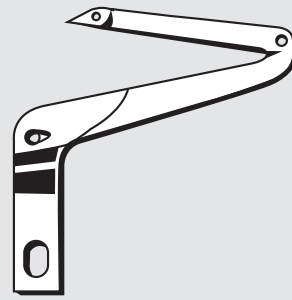

KL 65

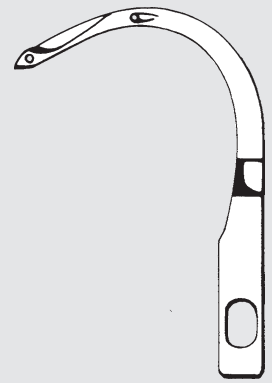

KM 04



LP 22



LP 24



LP 26

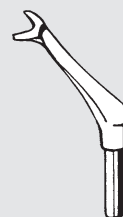

LP 21

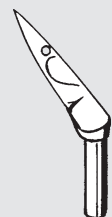

LP 36 A



C 007



CRL 09 J

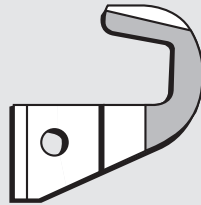

CRL 103

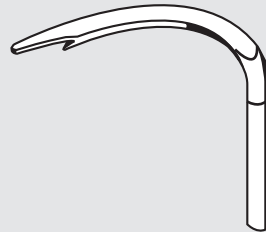

MH 41



MT 01

F 007

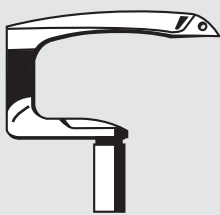

FS 03

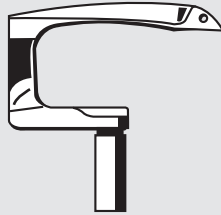

FS 04

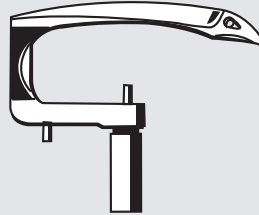

ME 28

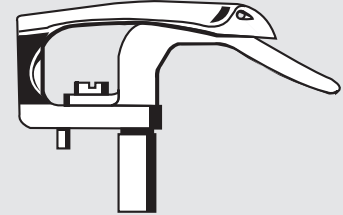

ME 28 P

HF 008

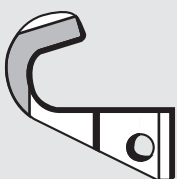

FR 34



FR 40

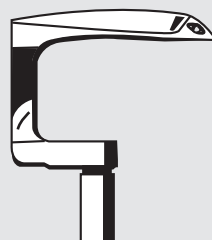

HE 21 Q

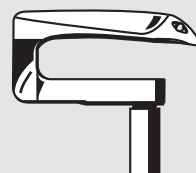

HE 22 Q



HE 22 R

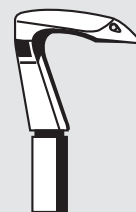

HE 21



HE 22



SC 88

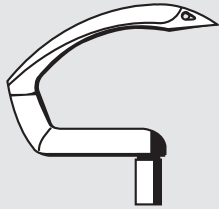

CB 28

VC 008

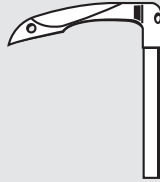

VE 51

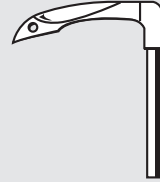

VE 51 P

Z 008

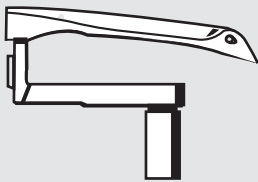

ZD 21

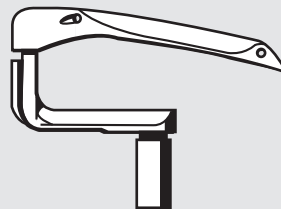

ZD 22



VLA 48-4
(18702 Adamson)



1870053



1840096

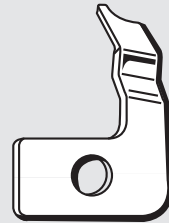

1840097



1870047
Kl. 141-23
-28
410
415



1870004
Kl. 141-21
-24
-27
-30
-40
-50



6300, 6600



1250004-229 B



1250004-237 B



1650004-229 (CT)



1270004-229 (CT)

AD 158

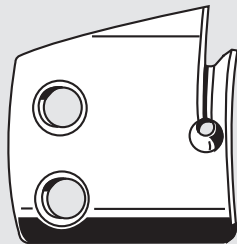

2111407-553-B

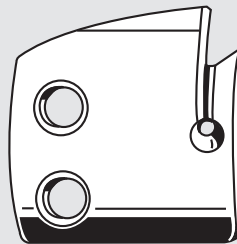

2111417-553-A



2111417-556-B

Treasure



11837 (T 830)



11563



2100, 2200

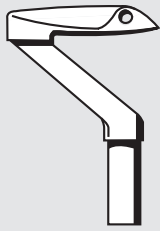

2108

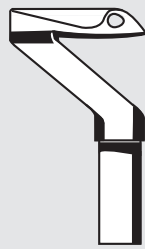

2108 G

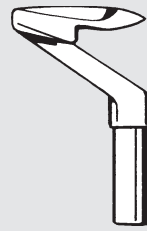

2108 A



2108 B



2111



2149 (AB)

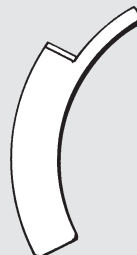

2170 (AA)

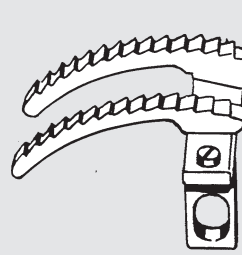

2105

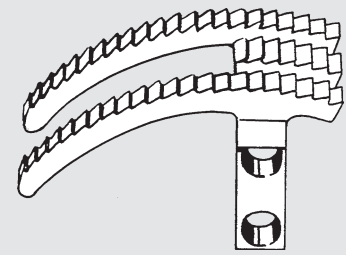

2126

2000 3000



2008 K (UX)



2008 Q (UXA)
3008 Q

33700

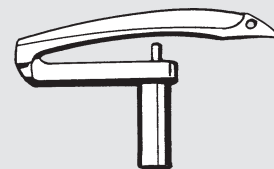

33709 C

35600, 35700, 35800



35796 B

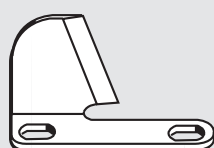

35796 C

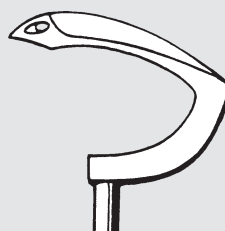

AV = 35809 AY



AU = 35808 AY



AY = 35809 BY



**34700, 34800
92800, 93800, 94800**

Serie CS + FS Seite 109
page 109
pagina 109



34709 (UR)



34709 D (URD)



34770 K

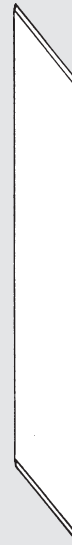

34749

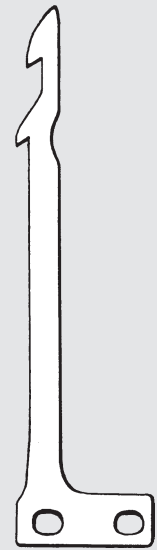

34749 K
34749 M
34749 P

36200 Flatseamer

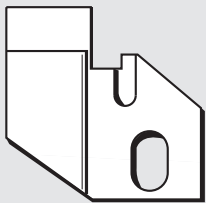

999-302 N 1033



36250 SUPER
A 10469



G 36250
= CT 36250



36270 SUPER
36270 B
A 10470



CT 36270

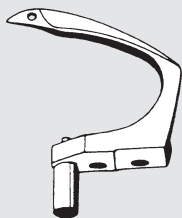

36208 A

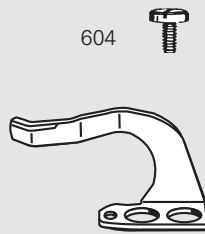

604

36210



36251 F



36251 FD



36251 E (A)



36251 W

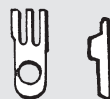

36240 (D)

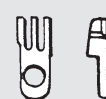

G 36240 (VD)

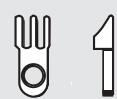

36240 J



39500



G 39570
39570

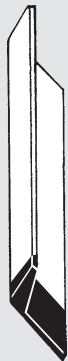

CT G 39570



39570 SC
Solid carbide
Metal sólido duro

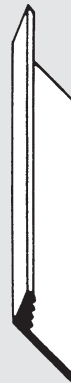

G 39570 A
(A 9181)

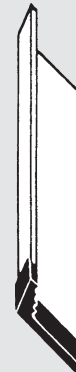

A 9392 (CT)



G 39570 JU
(A 9259)



39570 J



CT 39570 J

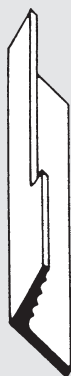

39570 K

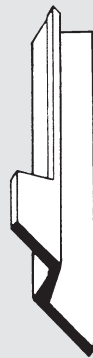

39570 L



CT 39570 L

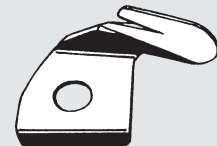

39556 K



39556 L



39549



39549 BAK
Ceramic



G 39549 N (CT)



39549 SC
Solid carbide
Metal sólido duro

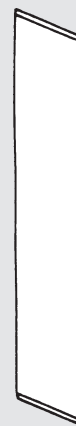

G 39549 JU
(A 9071)



G 39549 SU (CT)

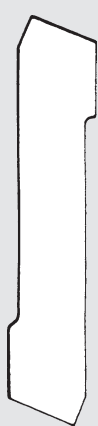

39549 J



39500



CT 39549 J

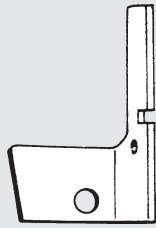

99669 K (GM)

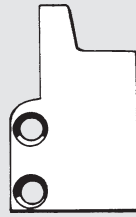

99670 L



99669 (GC)

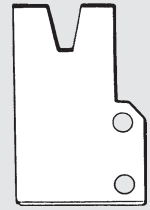

99670 (GD)



39508 B

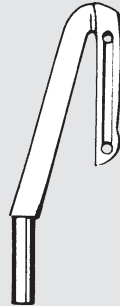

39508 D

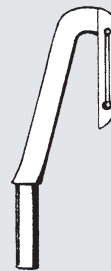

39508 P



39560 B

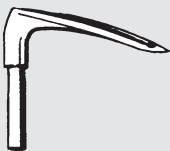

39508 A (CC)
G 39508 A (UM)

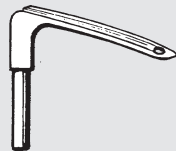

39508 E (CK)



G 39508 AV (GC)
(A 9050)

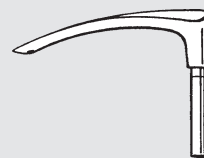

39508 C

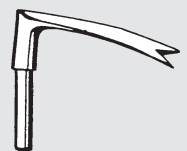

39560 A (E)

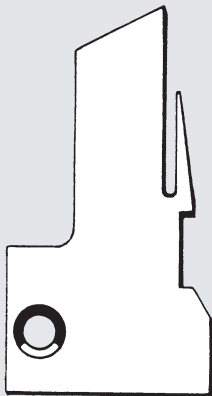

39524 AB 1/8
(AX 1/8)
ohne Transporterschlitz

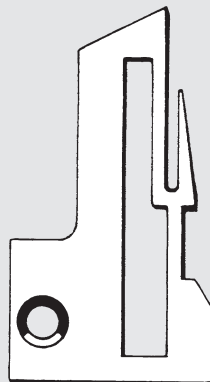

39524 AB 1/8
(AX 1/8)

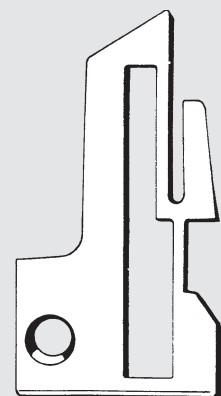

39524 AB 5/32
(AX 5/32)



39500

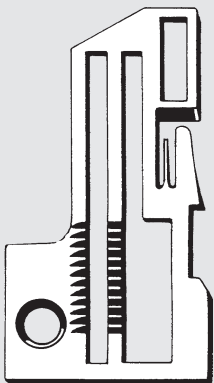

G 39524 AV (GB)

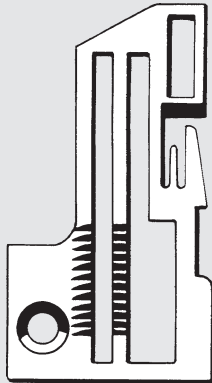

G 39524 AW (GC)
GB 39524 AW (HN)

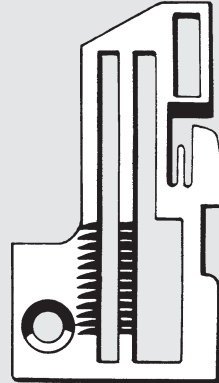

GA 39524 AW (HH) 5/32

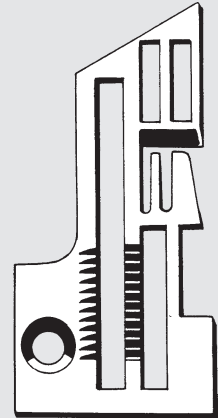

39524 W (AN)

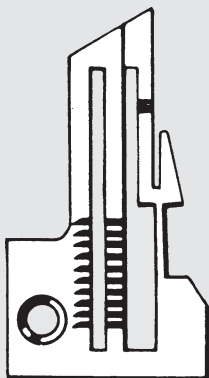

39524 B 3/32
(V 3/32)

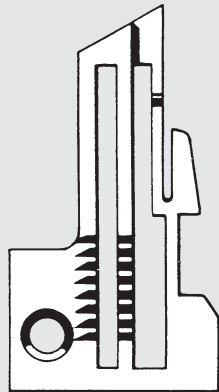

39524 B 1/8
(V 1/8)

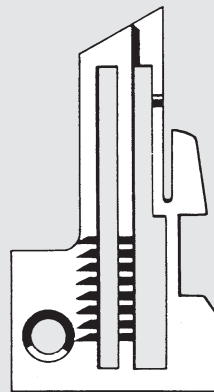

39524 B 5/32
(BH)

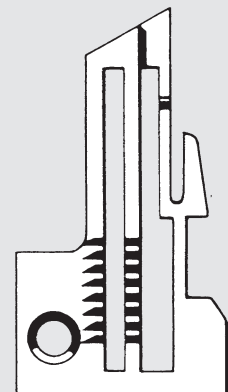

39524 P
(AJ)

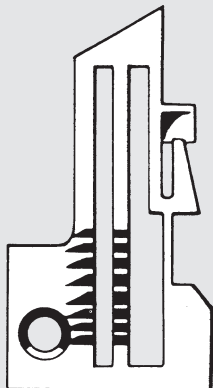

39524 C 1/8
(AC 1/8)

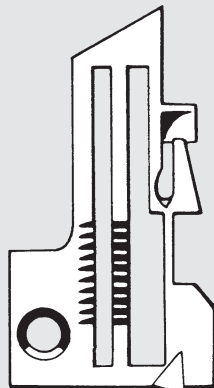

39524 C 5/32
(AC 5/32)

A 9953 1/8
(HV 1/8)

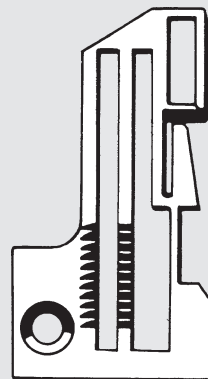

GA 39524 C 1/8 (HB)

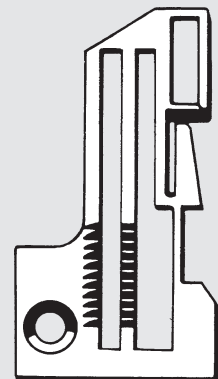

GA 39524 C 5/32 (HC)



39500

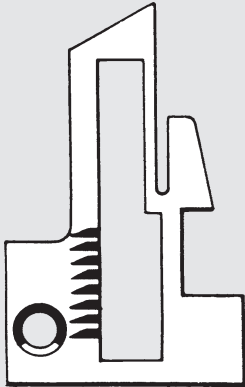

39524 J

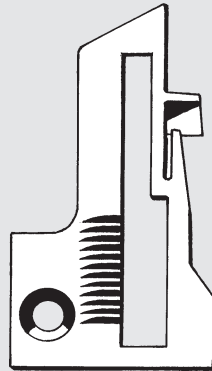

39524 AS (BE)

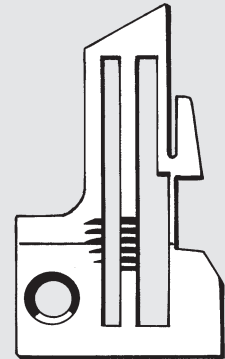

39524 D (AM)

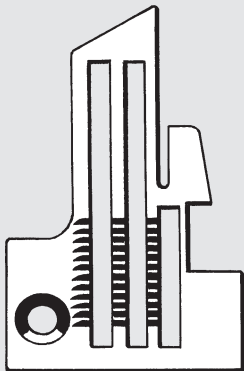

39524 N (AH)

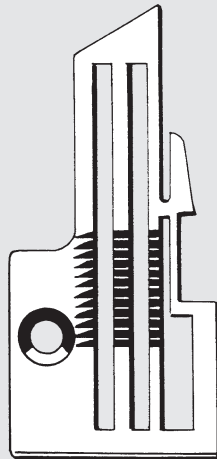

39524 BF 1/8 (BK)

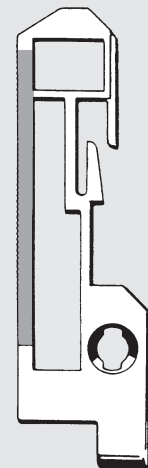

A 9608 B (HG)

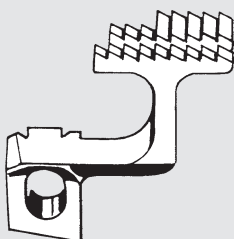

39526 AW

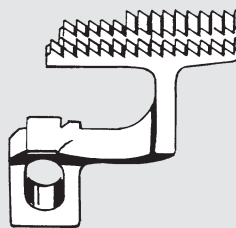

39526 B

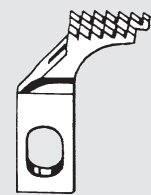

39505 B



39800

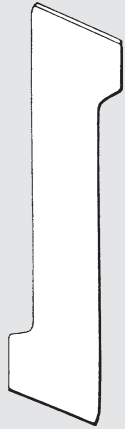

39849



CT 39849

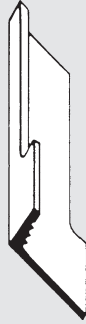

39870

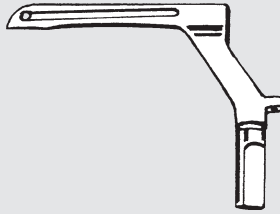

39808 CY

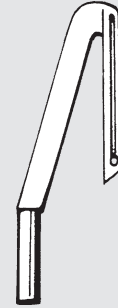

39808 D (ACZ)

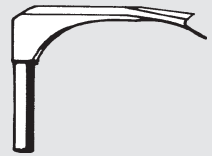

39860 H

SP 151, SP 161, SP 172

= Juki Seite 29-33
page 29-33
pagina 29-33

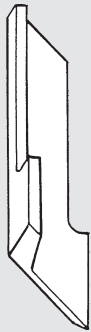

118-45906

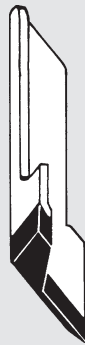

CT 118-45807



122-20307

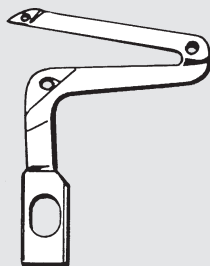

122-40107

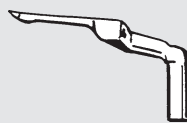

122-47508

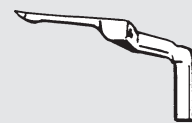

122-47102



39200

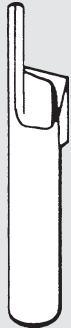

39270 A



39270 D



39270 E
Kl. 39200 / 39600

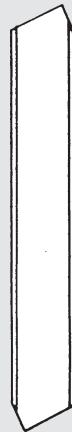

39249 A



39249

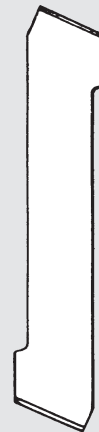

39249 K

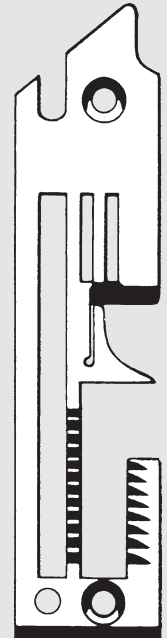

39224 AC 3/32
39224 AC 1/8
39224 J
39224 AA

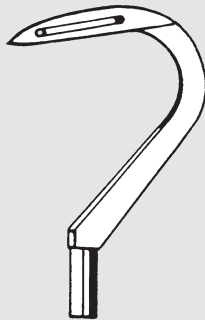

39208 B

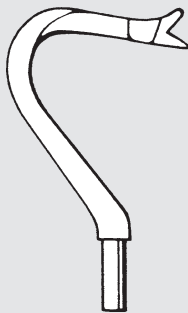

39160

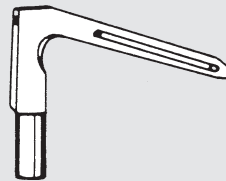

39208 AA

FS 122, 123, 132, 133, 311, 312, 322, 323, 332
CS 122, 132
92800, 93800, 94800
MFC 7000 Series
MF 7000 Series

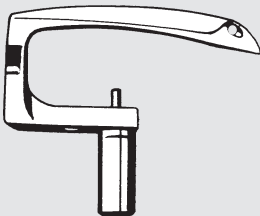

52708 B

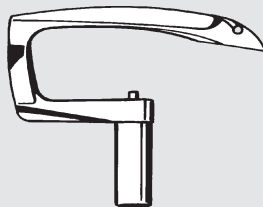

50309 K



34770 K



34770 EL



34709 D (URD)

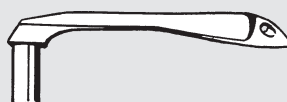

34709 (UR)

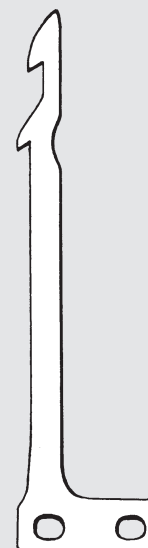

34749 K
34749 M



34749 EL



41300

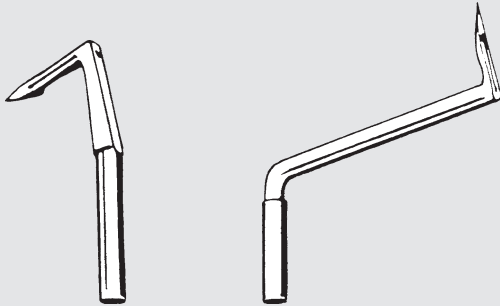

41308 B

41308 BX = 41309 A

51200

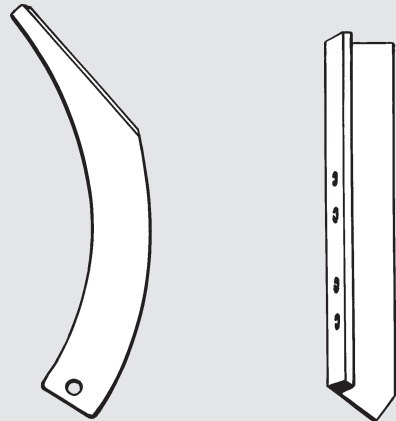

51249 B

51270 S

51700, 56700

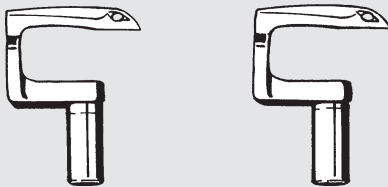

51708

51709

52700

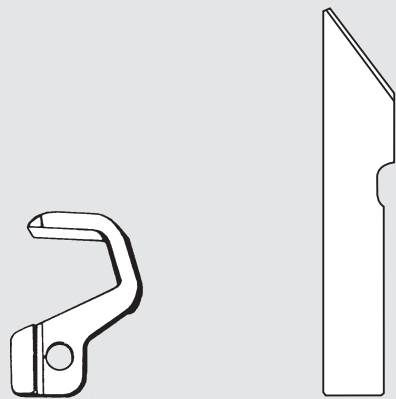

52770 C (B)
52770 D (E)

52749 A

57700

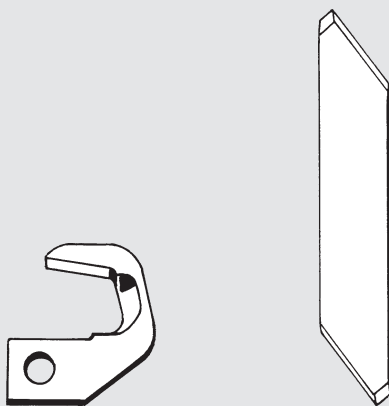

57770 A (D)

57949



52700 BKZ Galkin

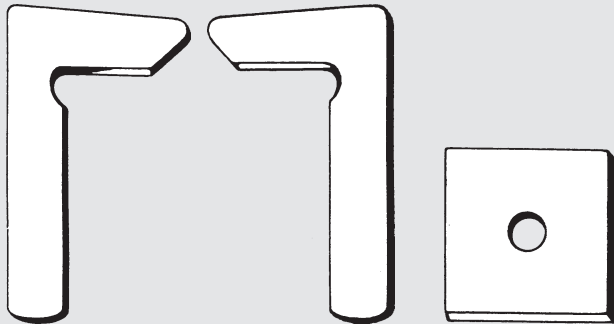

167 L
CT 167 L

168 R
CT 168 R

169

57700 BKZ Galkin

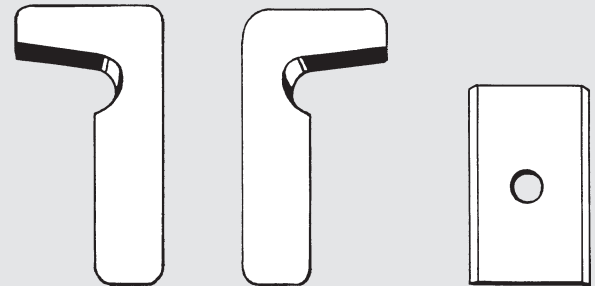

CT 11110

11111
CT 11111

CT 11109

53100

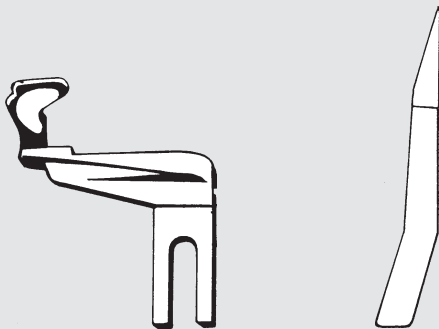

G 53170 R

9949 AR

53300, 53400

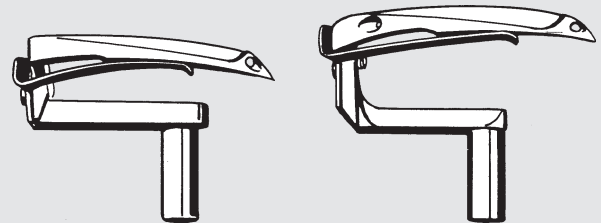

53407

53409

54200, 54400

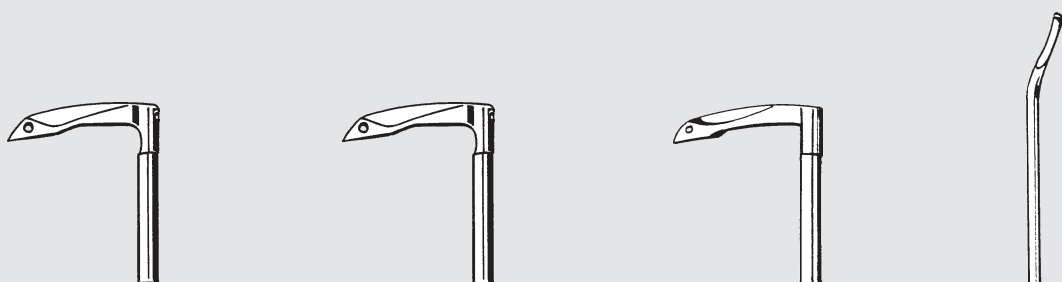

54208 B

54208 (BZ)

54208 A (CB)

54211 A



**52700, 52800, 52900
57700, 57800**

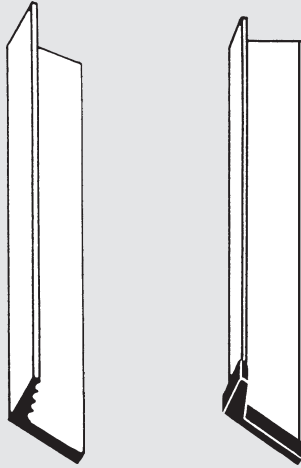

52970 E

A 9464 (CT)
= 52970 D (CT)

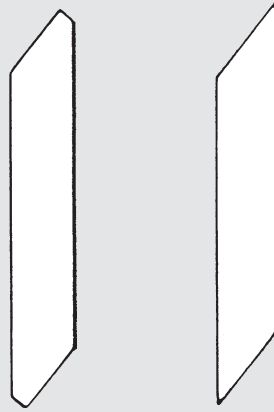

52949 A

52949



52970 C

CT 52970 C

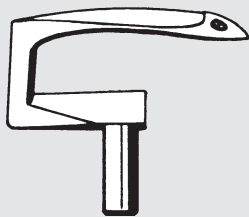

52808 E

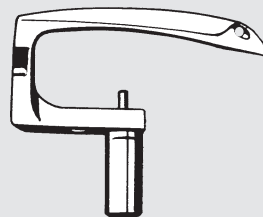

52708 B

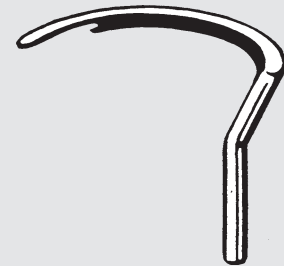

52845 A (B)
= 52945 M (F)

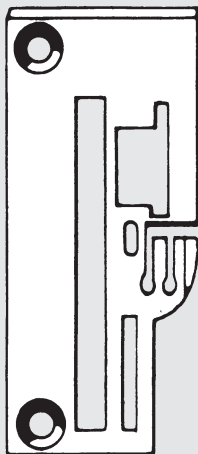

G 52928 A 5-8

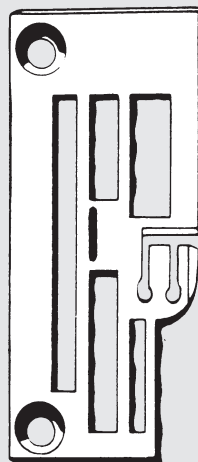

52928 A 16-8

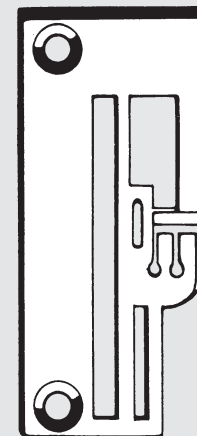

52924 BH 5-8



51400, 51408, 51900, 52300, 52900
XF 500, LF 611
53700, 53800, 56900

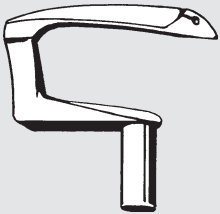

G 51409 C

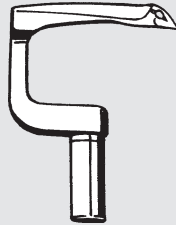

51409

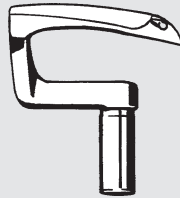

51408-12

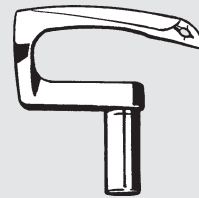

51408-16

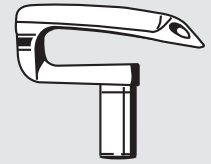

51508 M-18

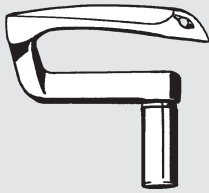

51908 B-8

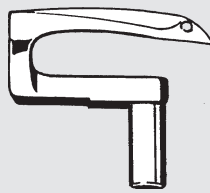

51908 B-9

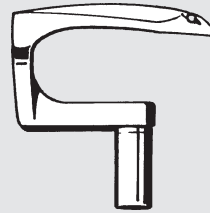

51909 C

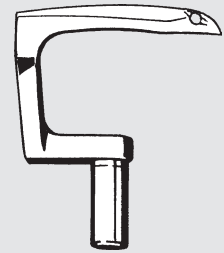

51909 D-9



51470



51449



CT 51449



52949 B



A 9540



15400



15470



15449



15408 A



15408 G



15460

75400



75449



75470 LA

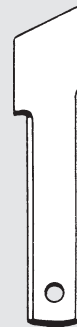

75449 LA

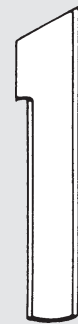

75449 LB
75449 LA

Lewis



36-16
KI. 150



36-19
KI. 156-20



36-21
KI. 200



**81200, 80200, 80600, 80700
80800, 81300 A, 81500**

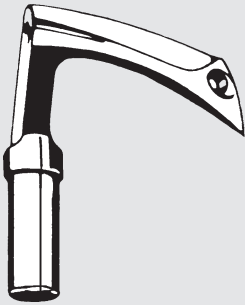

AS 26 XA

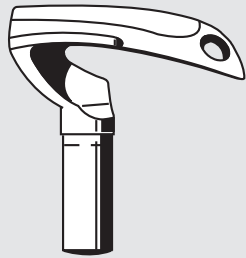

A 8375

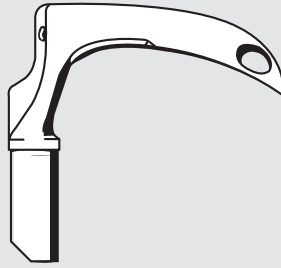

A 8376

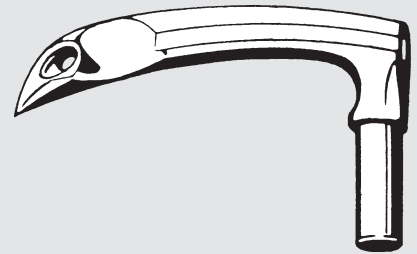

81208

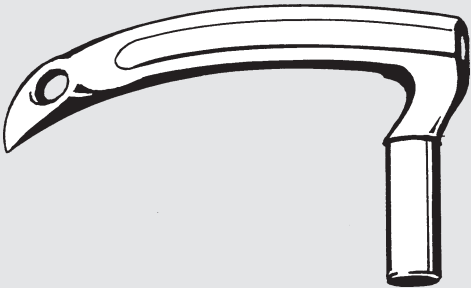

81508



81311 B

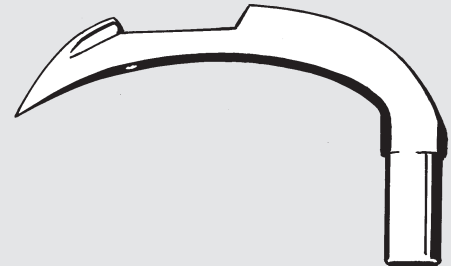

81308 B

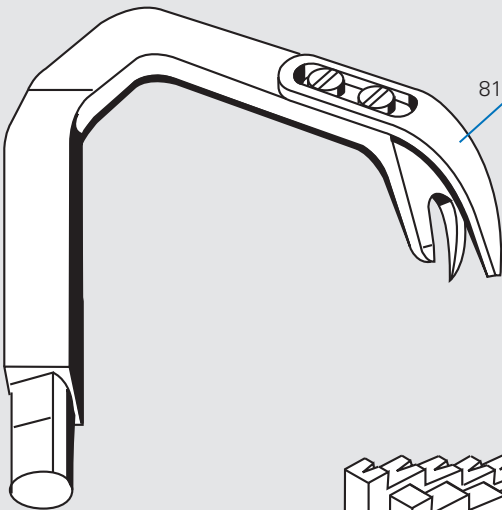

81507

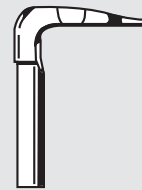

81511

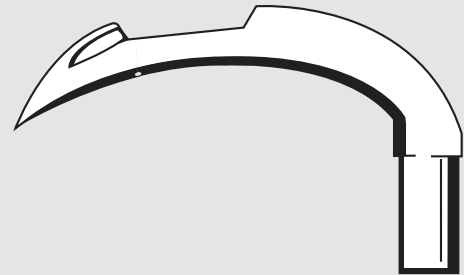

81308 C

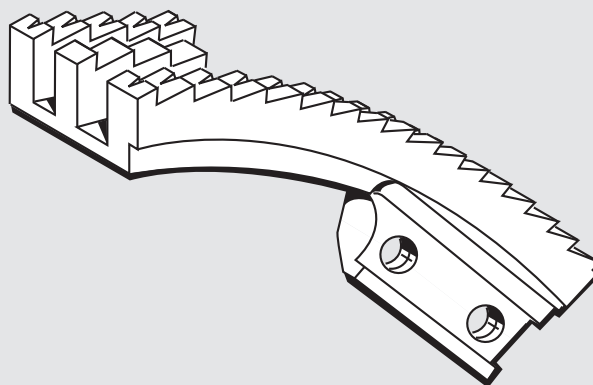

81326



81200, 80200, 80600, 80700
80800, 81300 A, 81500

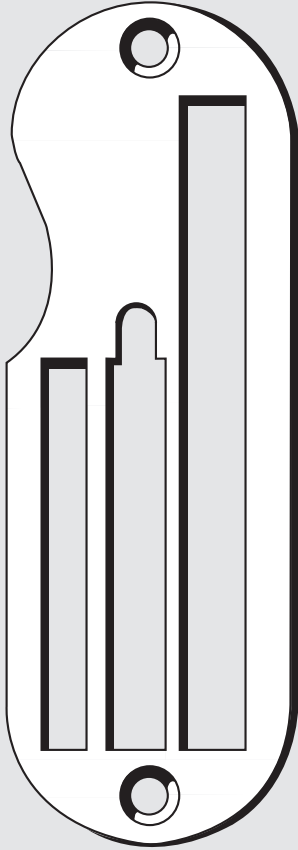

80224

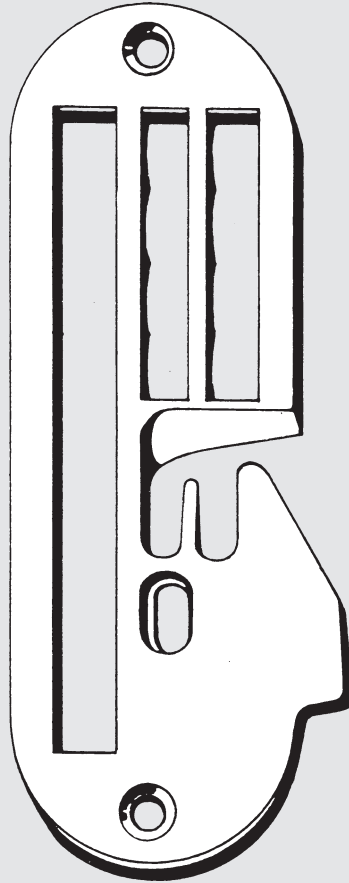

81224 AB

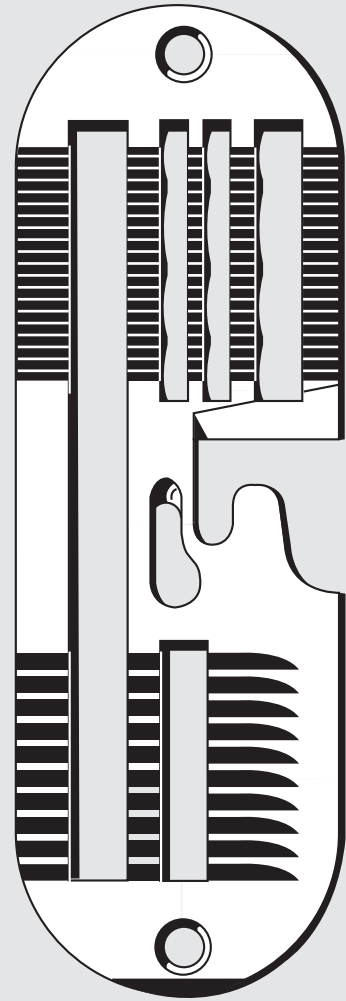

81324 A

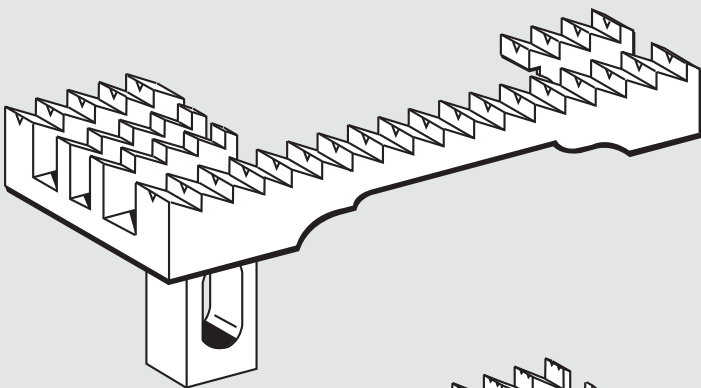

81305 A

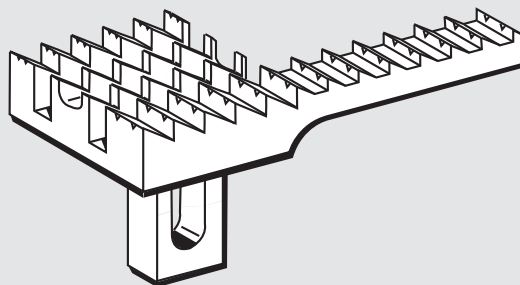

80205

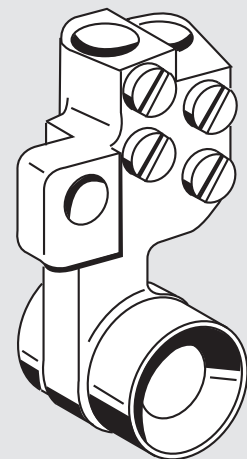

A 8377



Overlock



1662



1657

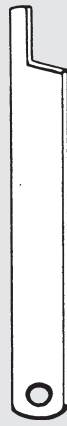

1662 A



1655



5350

1301, 1311 Flatlock und Feldlock



3544 A (HSS)
312-870-003



CT 3544 A
312-870-004



3543 (HSS)
312-870-001



CT 3543
312-870-002



3018
312-800-026

503, 504, 514, 515, 516
E 32, E 52, E 56 etc.

siehe Pegasus
see Pegasus
véase Pegasus



800, 1412 Superlock



D 110-10
313-870-003
CT D 110-10



D 119-10
CT D 119-10



D 110-8 A
313-870-015
CT D 110-8 A



D 119-7
313-870-002
CT D 119-7

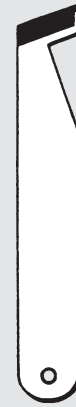

441031 (CT)
313-870-005 (CT)



442001
313-810-012

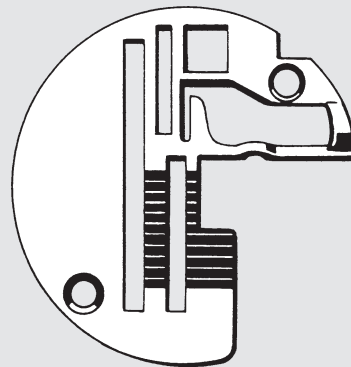

D 250-17 B

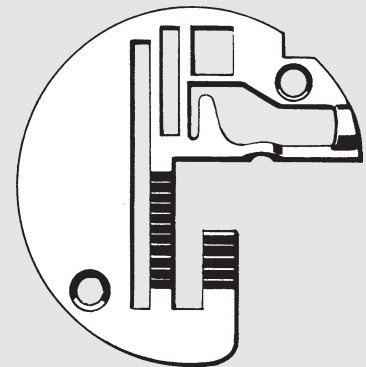

D 250-18 A
313-801-025

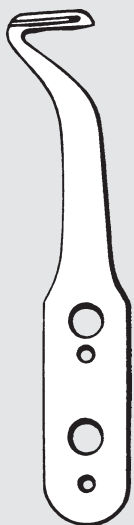

D 60-3
313-810-010



D 80-4
313-810-001

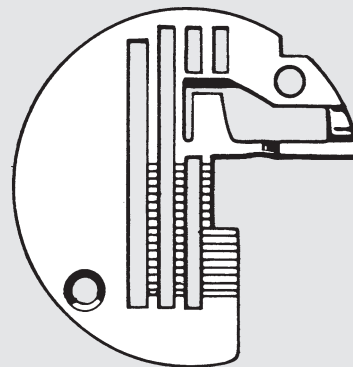

D 250-39
313-801-036



DCZ 203, 220, 222
DC, DCY, DCZ 221, 331, 341, 428, 520, 521
Z 830, 831, 833
Z 610

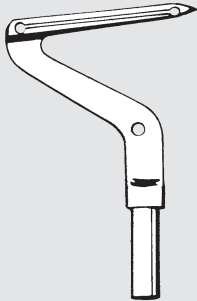

34392
32790

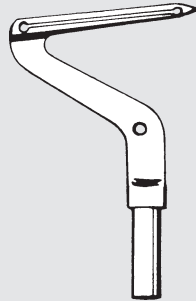

34393
32415

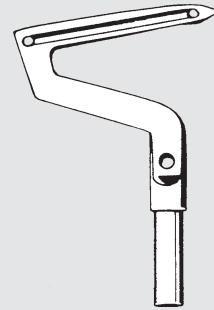

32541

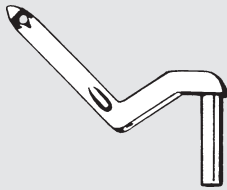

35227
32539

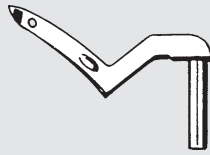

34730
34599

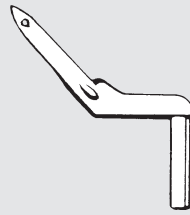

32807

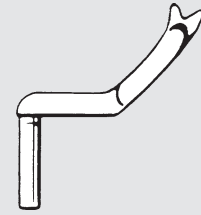

32813

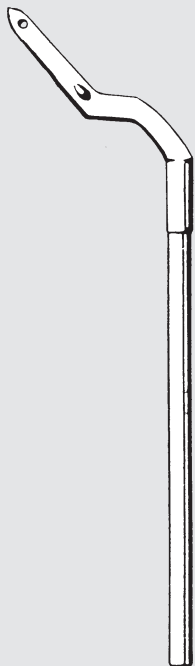

34113

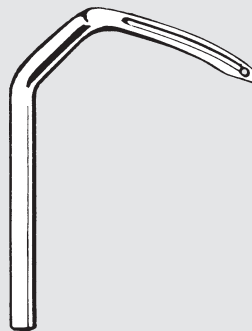

33059

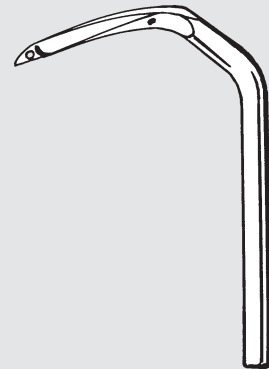

31877

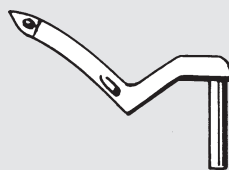

34519

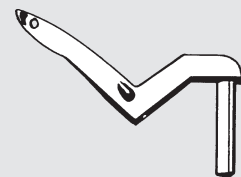

34584



DCZ 203, 220, 222
DC, DCY, DCZ 221, 331, 341, 428, 520, 521
Z 830, 831, 833
Z 610



37514



CT 37514



37538



CT 37538

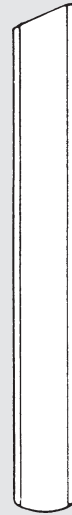

30421



38332



35285



32914 (CT)

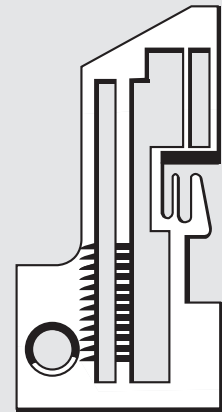

33821

VT 2500



4301125

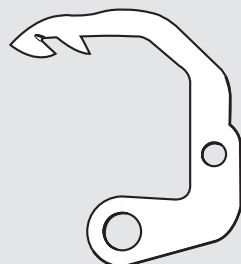

4301119

DW 1802, 1804



66601



66621



**DT 30
VX 2400, 2500**

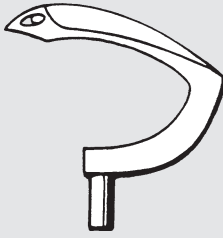

69085



69084

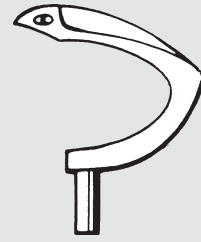

69086

FD-62 Flatseamer



68184 SUPER



CT 68184

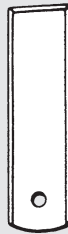

68121 SUPER



CT 68121

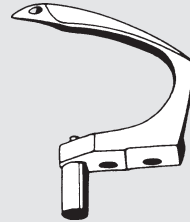

68217



4284



68218

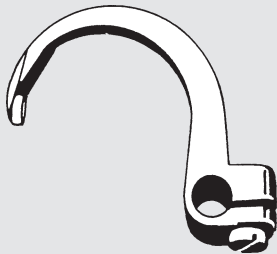

68124

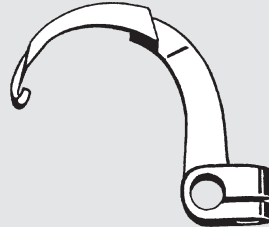

3021092
68124 SF
= Kl. FD-62-07 MS



68123



68560

**CB 201-234
CB 501-544**



85168

**CM-263, CM-268, CM-364
CM-352, CM-474**



80413

46, 47

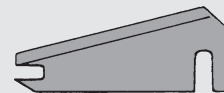

15487 Ceramic



Z 1000, ZF 1000, Z 1500 Series
Z 2000, Z 3000, Z 5000, Z 6000 Series
AZ 6000, AZ 8000 Series
AZF 8000 Series
AZG 8000 Series
CZ 6000 Series



CT 20491 G

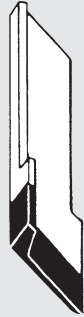

CT 20491

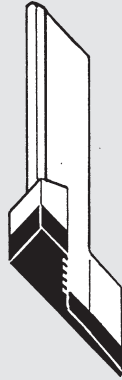

2121107 (CT)



20496 (CT)
6200022



20498



23582



2121111



2100167
6200097



2101091



2110305



14136
Kl. ZF 1500



20271

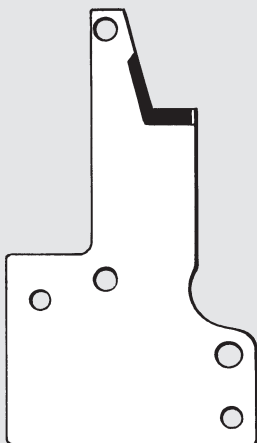

2111055 (CT)

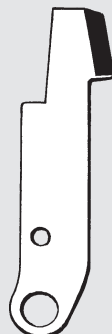

2111056 (CT)

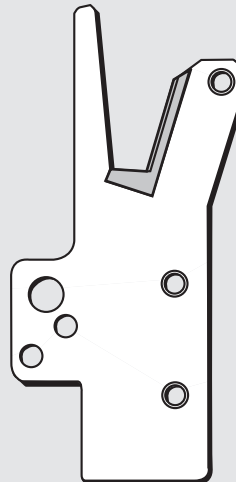

2101155 (CT)

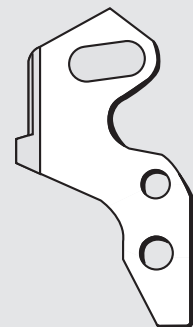

2101156 (CT)



Z 1000, ZF 1000, Z 1500 Series
Z 2000, Z 3000, Z 5000, Z 6000 Series
AZ 6000, AZ 8000 Series
AZF 8000 Series
AZG 8000 Series
CZ 6000 Series

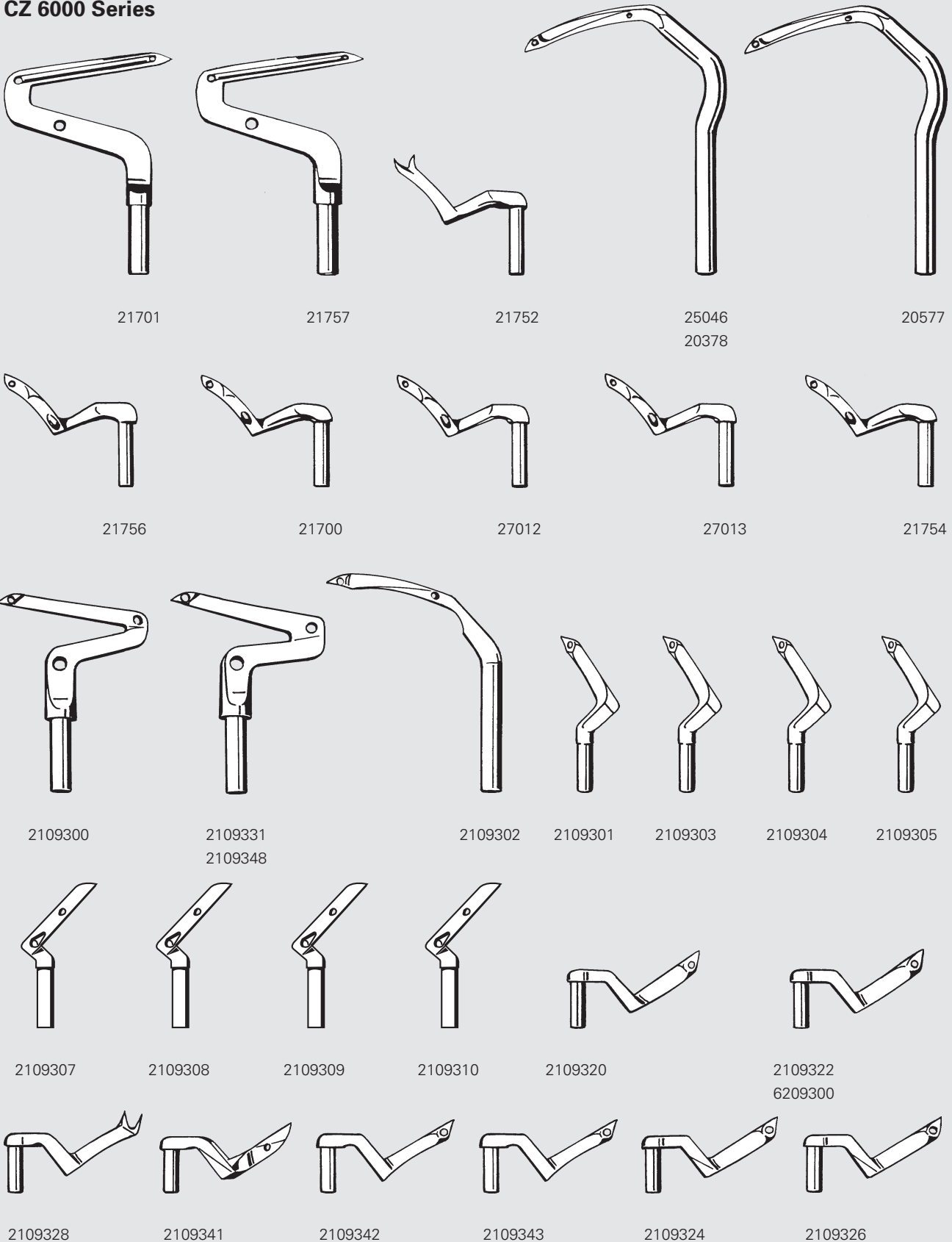



Z 1000, ZF 1000, Z 1500 Series
Z 2000, Z 3000, Z 5000, Z 6000 Series
AZ 6000, AZ 8000 Series
AZF 8000 Series
AZG 8000 Series
CZ 6000 Series

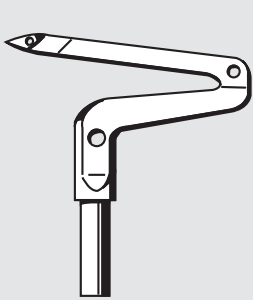

2109334

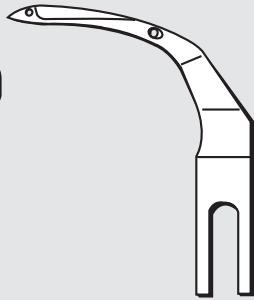

2109335

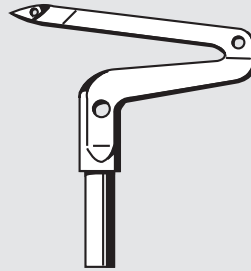

2109347
6209301

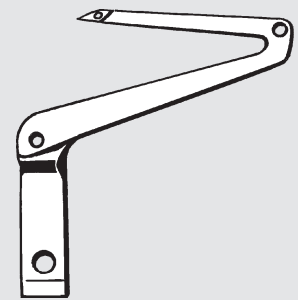

2119305

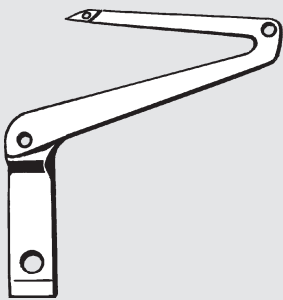

2119324

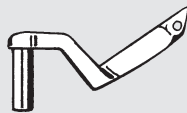

2119322 (F3)

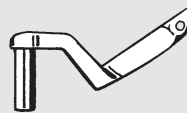

2129300

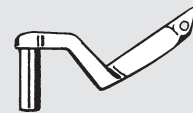

2119301 (Y1)

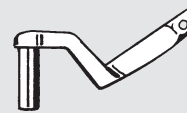

2119302 (Y2)

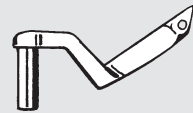

2119303

DV 1200, 1400
DW 1200, 1400



95277

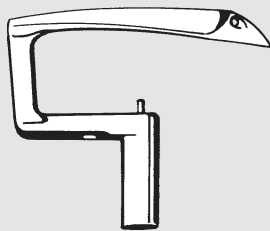

95499

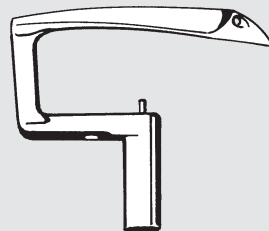

95174
94480
93310



95276 (CT)



94417 (CT)

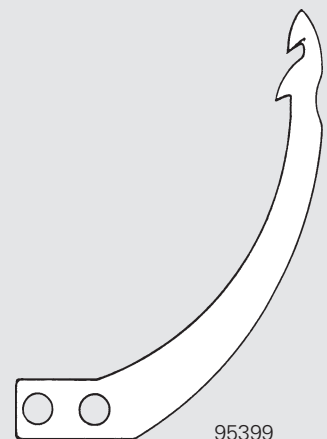

95399



VC 2400, 2600, 2700, 2800, 3600, 3700, 3800
VE 2700
VF 2300 M, 2400, 2500, 2800
VG 2700, 3700
VGS 2700, 3700

CC 2700, CFZ 2300 M
MG 2000, VM 1800
VFS 2500
VES 2700



95276 (CT)



3501032 (CT)



3101633



3501200

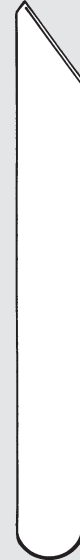

3101607



3201062



3101026



3101028 (CT)



3101465 (CT)

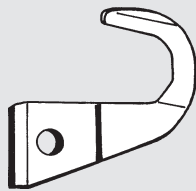

3110037 (CT)

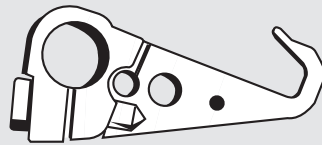

3501534

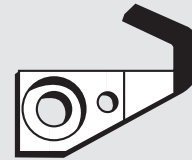

3501535 (CT)

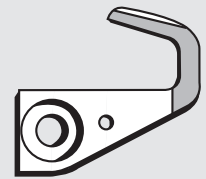

3501597

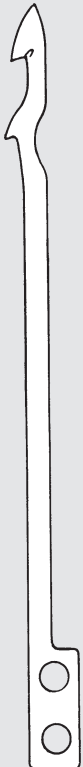

3120151



3100513



3100512



3110038

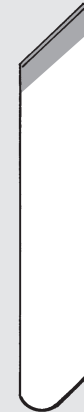

CT 3110038



3100708



VC 2400, 2600, 2700, 2800, 3600, 3700, 3800
VE 2700
VF 2300 M, 2400, 2500, 2800
VG 2700, 3700
VGS 2700, 3700

CC 2700, CFZ 2300 M
MG 2000, VM 1800
VFS 2500
VES 2700



3101801

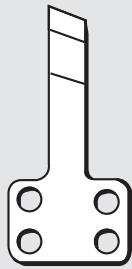

3101802



3101699



3101700



3120016



3501026



3109300

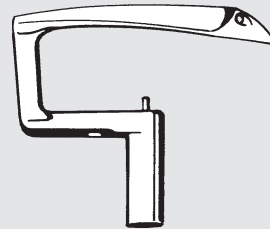

3209311



3109306

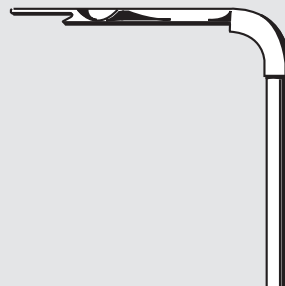

3109310



**Blindstichnähmaschinen
Blindstitch Sewing Machines
Máquinas de puntada invisible**



Brother
Kl. CM 2-B931
Nr. 110121-001



Columbia
36 C 22-1



Lewis
36-16
Kl. 150



US
3430-22



Strobel
VLA 48-4
(18702 Adamson)



Strobel
1870053



11837 (T 830)



Yamato
80413

Barudan

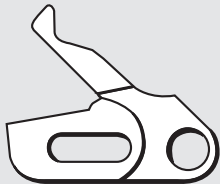

KB 270010

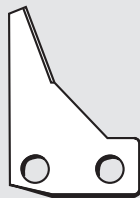

KN 270960



KN 270950
KN 270951

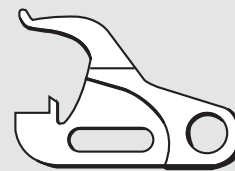

KN 270952



KN 271602
KN 271980

British United Shoe Machinery Co.



KZG 502 E



KZG 757



Clinton

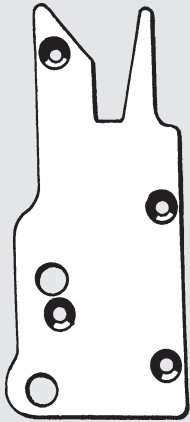

01-4434-01
für Union 39500/39600
W & G 504/514

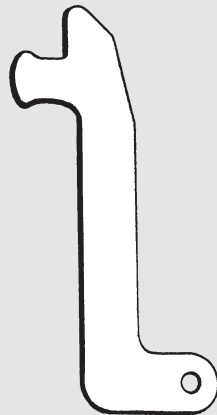

01-4435-01
für Union 39500/39600
W & G 504/514

Gribetz

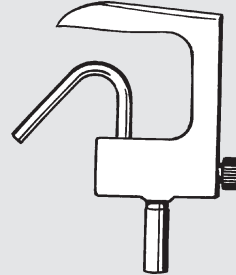

P3-0146

Meca

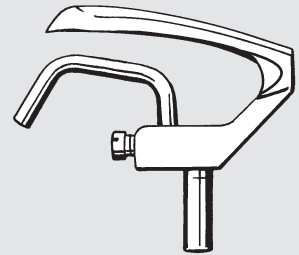

Meca

Sotco



Sotco oben
Nr. 514



Sotco unten
Nr. 510 S

Metropolitan



525 W
KI. 30-A

Diamant FR

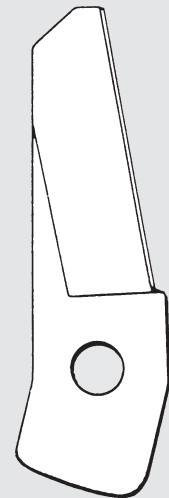

Diamant FR
CT Diamant FR



Kettelmaschinen (Kettma, Böttger, Sotco usw.)

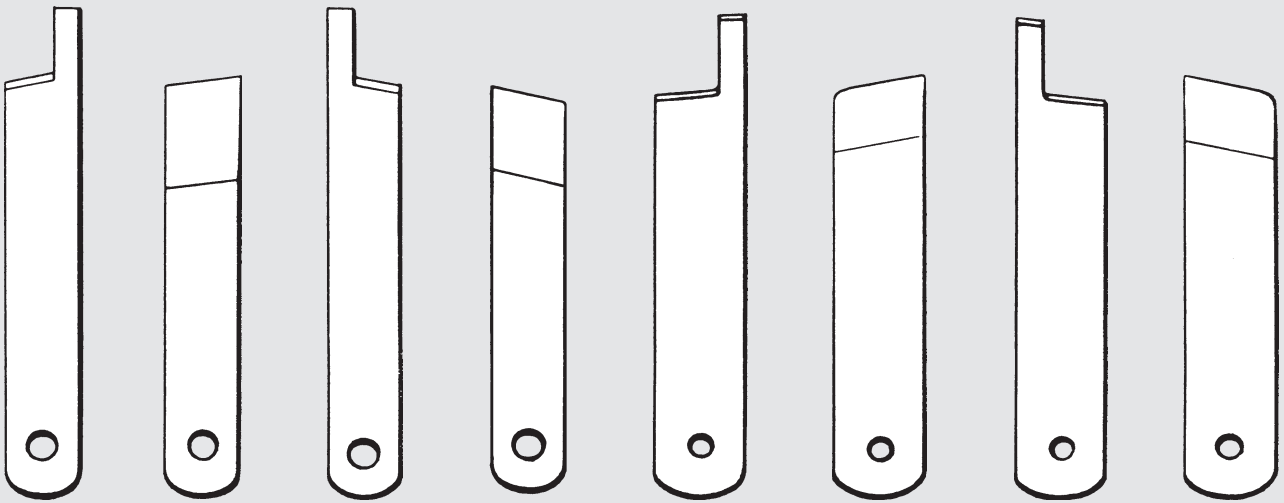

JK-R
und VB-R
oben rechts

JK-R
und VB-R
unten rechts

JK-L
und VB-L
oben links

JK-L
und VB-L
unten links

breite Kettelmesser
rechts oben rechts unten

breite Kettelmesser
links oben links unten

Titan – Baratto



330 ACAR (CT)

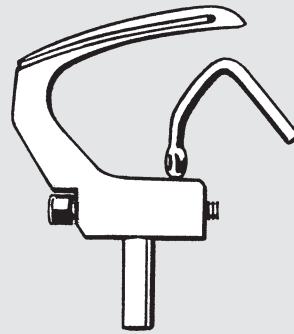

27264

Tajima

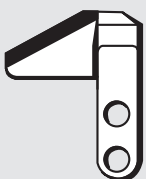

AT 0202 000 000 (CT)

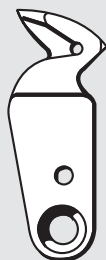

AT 0204 000 000

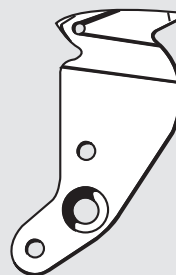

FX 0206 000 000



FX 0207 000 000 (CT)



Pfaff



29-924993-70/876

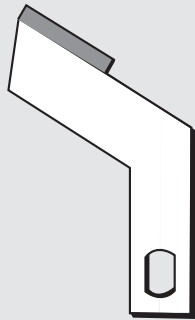

29-924993-81/957

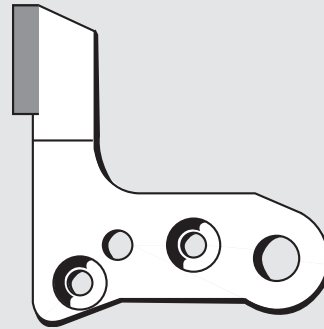

29-924993-81/704

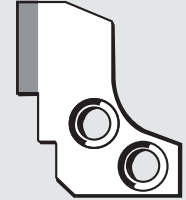

98-788013-00/900



29-924993-81/668



29-924993-71/442



29-924993-70/641



98-784045-02/000



29-924993-56



29-924993-70/299



29-924990-88

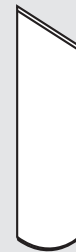

29-924992-56/100



93-415504-49

Husquarna



21410042-37



21410042-29



4156597-01



4156628-01



Juki Babylock



305249



205-9102-01 A (CT)



305248



405-9102-01 A

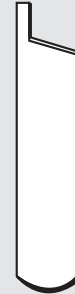

408-9101-01 B



408-9102-01 A



PL-Q11-01 A

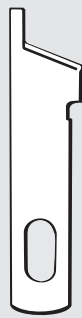

PL-Q11-01 C



PL-R11-01 A



SE-R11-01 A



60507 (CT)



60544

Bernina (Bernette)



50143403 (CT)



50145403

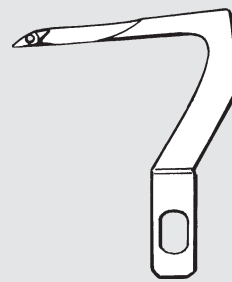

418-6101-02 A



714-6101-01 A

Singer



1-412749-000











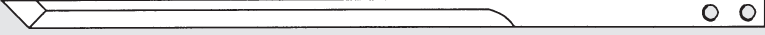
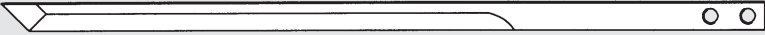
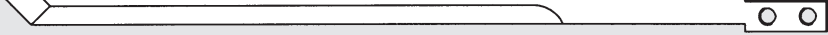

1-550449-000

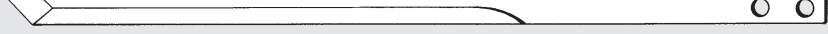
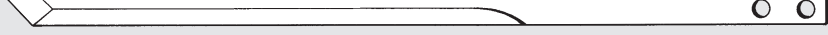
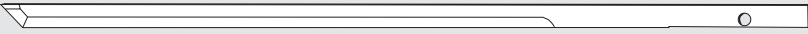

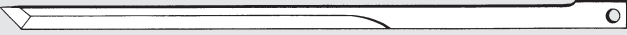
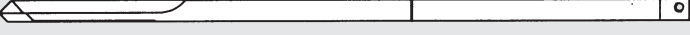



412585



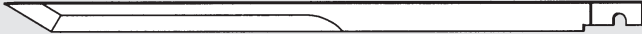

Bullmer		105934	169 x 2,0 x 6
		103630	169 x 2,0 x 6 H hohl / hollow / hueco
		104264	201 x 2,5 x 8 G glatt / smooth / liso
		100124	201 x 2,5 x 8 H hohl / hollow / hueco
		104450	223 x 2,5 x 10 / 8
		104607	223 x 2,5 x 10 / 8 GR glatt / smooth / liso runder Rücken / round back / lomo redondeado
		105935	223 x 2,5 x 10 / 8 K kurzer Schnitt / short cut / corte corto
		103986	223 x 2,5 x 8 G glatt / smooth / liso
		102642	223 x 2,5 x 8 H hohl / hollow / hueco
F.K.			291 x 2,5 x 8
Gerber		095581300	128 x 0,9 x 5
		G 93	175 x 1,5 x 6,3
		G 93 HPC / S 5200 1100880 / 054782004	195 x 2,0 x 7,9
		G 3000 / 3200 PN 07338700	202 x 2,1 x 6,3
		085878000 GTXL	206 x 1,9 x 7,9 / 6,4
		G 91 / G 93 / Z7 S 7200 / S 7500	254 x 2,35 x 8 Bohrung / hole / taladro
		G91 / S 93 / Z7 S 7200 / S 7500 02126109	254 x 2,35 x 8 Schlitz / slot / hendidura
		032419013	254 x 3,13 x 9,7 Heavy duty

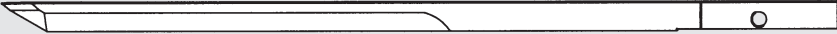

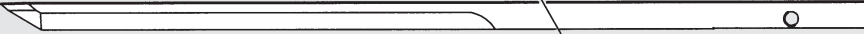



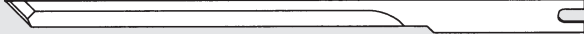



Investronica

	CV 2	45,5 x 1,5 x 6,5
	SC 4 DIS, S 40 81700300	187 x 1,95 x 8
		245 x 2,52 x 8,3 / 7,8
	S 70817001301	245 x 3,0 x 8,3 / 7,8
	S 70817001 E 02	252 x 2,5 x 7,8 / 8,3
		291 x 2,52 x 7,85
	SC 2	296 x 2,52 x 8 K kurzer Schnitt / short cut / corte corto

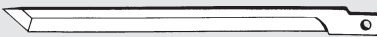
Kuris

		84 x 1,0 x 5
	ZAT 3 Nr. 24306	178 x 2,5 x 10
	TexCut Nr. 47968	227 x 3,0 x 10,5 / 9,0

Lectra

	Vector 2500	89 x 1,5 x 5,5
		89 x 1,5 x 5,5 / 3,5
	System 95	113 x 2,0 x 7,5 / 6
	System 95	113 x 2,0 x 7,5 / 6 H hohl / hollow / hueco
	System 95 Vector 500 / 5000	296 x 2,0 x 7
	System 95	296 x 3,0 x 8,5 / 6,5
		296 x 3,0 x 7
	116802 Vector 7000	360 x 2,4 x 7
	System 96 Vector 7000	360 x 3,0 x 8,5



Diverse Vollhartmetall Messer / Knives solid carbide / Cuchillas metal solide duro

Zünd



Z16



Z17



Z21



Z29



Z10



Z41



Z42



Z43

Comelz



HZ5K.S



HZ3B

Atom



01039999



01040445



107506 T
Bullmer



TL055
Gerber



F0495H
Lectra









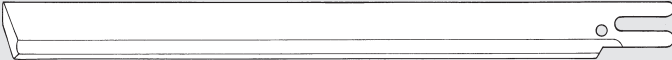
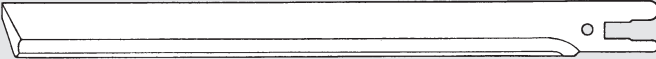
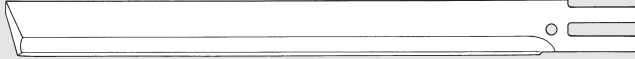

Setec

Alle Messer auch beschichtet verfügbar
 All knives coated available
 Disponibles todas las cuchillas recubiertas

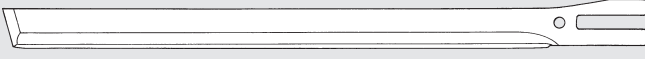
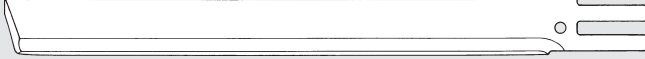
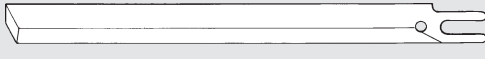
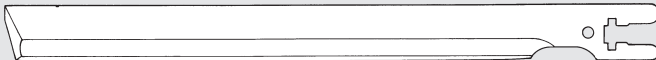
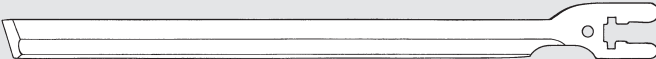
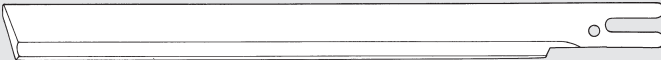

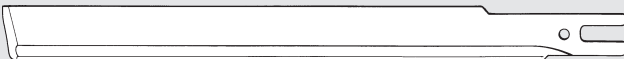
HSS-Stahl • High-Speed-Steel • Acero rápido de alto rendimiento

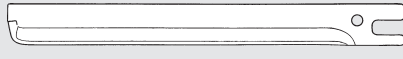
Abmessungen / Sizes /
Dimensiones:

	Beaver/Bullmer	5", 6", 7", 8", 9" 10", 11,5", 13", 14"
	Comet/Gury	4", 5", 6", 7", 8", 9" 10", 11,5", 13", 14"
	Eastman/Suprena	4", 5", 6", 7", 8", 9" 10", 11,5", 13", 14" 8" S 0335, 10" S 0352
	Eastman Servo Cutter 16,5	6", 8", 10" gerade geschliffen = 16,5 mm ground straight at the back = 16,5 mm Lomo afilado recto = 16,5 mm
	Eastman Servo Cutter 14,3	6", 8", 9", 10" ausgeschliffen = 14,3 mm ground off at the back = 14,3 mm Lomo rectificado = 14,3 mm
	KM/Hoogs KS-AU	5", 6", 7", 8", 9", 10", 11,5", 13"
	KM Automatik KS-EU	5", 6"
	Maimin	5", 6", 7", 8", 9" 10", 11,5", 13", 14"
	Maimin Servo Cutter	5", 6", 7", 8"
	Wolf	5", 6", 7", 8", 9", 10", 11,5", 13"
	Kuris-KV	KVW 70 / 4" 15056 KV 90 / KVW 12 / 5" 15105 KV 115 / KVW 15 / 6" 15155 KV 140 / KVW 18 / 7" 15205 KVW 20 / 8" 15256 KV 200 / 10" 15305
	Kuris-KV 4	KV 1100 / 6" 15383 KV 1350 / 7" 15382 KV 1600 / 8" 15380 KV 2000 / 10" 15381
	Kuris	KVS 700 15376
	Kuris	KVS 900 15389
	Kuris Servo Cutter	SC 700 / 4" 15388 SC 900 / 5" 14237 SC 1100 / 6" 14637 SC 1350 / 7" 14638 SC 1600 / 8" 14638 SC 2000 / 10" 17627

Sämtliche Messer auch konvex/gewellt verfügbar
All knives are also available as: convex/wavy
Todos las cuchillas también como edición convexo





Hoogs



**Kuris /
Maimin
Suprena**



Bullmer

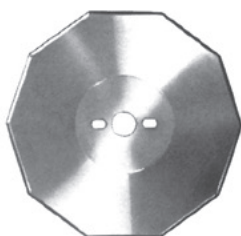

Bullmer

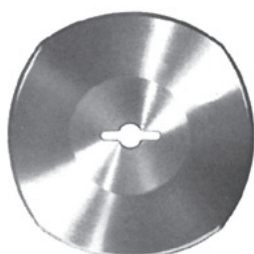

Hoogs

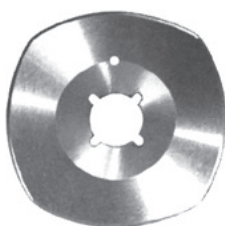

**Kuris /
Suprena**

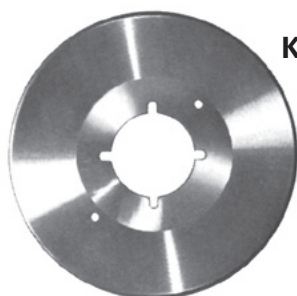

Kuris

Für Fabrikat For Machines Para producto	Messerform Shape of knives Forma de la cuchilla	Außen Ø Outer dia. Diámetro exterior	Bohrung Hole Espesor	Stärke Thickness Taladro			
Type		mm	mm	mm			
Bullmer							
602	für 0250/1	10-kant	-sided	-cantos	50	14x8x2,5	1,0
604, 801	für 0470/1	10-kant	-sided	-cantos	59	10	1,0
601, 605	für 0570/1	10-kant	-sided	-cantos	79	10	2,0
607	für 0674/1	rund	round	circulares	100	10	1,5
606, 607, AV300	für 0670/1	10-kant	-sided	-cantos	100	10	2,0
	für 675/1	4-Bogen	-curves	-arcos	100	10	2,0
	für 970	4-Bogen	-curves	-arcos	110	15	1,5
608, 609	für 840R	rund	round	ciculares	126	45	1,0
	für 870/1	10-kant	-sided	-cantos	126	45	1,0
Hoogs							
Piccolo, Liliput, Favorit	MS-1	rund	round	ciculares	50	25x10x4	1,2
Piccolo, Liliput, Favorit	MS-3	10-kant	-sided	-cantos	50	25x10x4	1,2
Piccolo, Liliput, Favorit	MS-2	4-Bogen	-curves	-arcos	50	25x10x4	1,2
Piccolo, Liliput, Favorit	MS-55	7-Bogen	-curves	-arcos	50	25x10x4	1,2
IAK, IAG, Goliath	MS-10	rund	round	circulares	60	25x10x4	1,2
IAK, IAG, Goliath	MS-11	4-Bogen	-curves	-arcos	60	25x10x4	1,2
IAK, IAG, Goliath	MS-12	10-Kant	-sided	-cantos	60	25x10x4	1,2
Z+St	MS-20	rund	round	circulares	110	25x10x4	1,5
Z+St	MS-21	4-Bogen	-curves	-arcos	110	25x10x4	1,5
Z+St	MS-22	10-Kant	-sided	-cantos	110	25x10x4	1,5
X-130, X-130-N	MS-28	rund	round	circulares	130	25x10x4	1,5
X-130, X-130-N	MS-29	4-Bogen	-curves	-arcos	130	25x10x4	1,5
X-130, X-130-N	MS-30	10-Kant	-sided	-cantos	130	25x10x4	1,5
Kuris							
Novita	15780	rund	round	circulares	50	16	1,0
Novita	16110	6-Bogen	-curves	-arcos	50	16	1,0
Novita	16120	8-Bogen	-curves	-arcos	50	16	1,0
Supernovita		rund	round	circulares	57	16	1,0
Supernovita		6-Bogen	-curves	-arcos	57	16	1,0
BOM 60	15752	rund	round	circulares	60	22	1,0
BOM 60	16000	4-Bogen	-curves	-arcos	60	22	1,0
BOM 30/80	15762	rund	round	circulares	80	22	1,0
BOM 30/80	16012	4-Bogen	-curves	-arcos	80	22	1,0
BOM 30/80	16092	6-Bogen	-curves	-arcos	80	22	1,0
BOM 30/80	16162	8-Bogen	-curves	-arcos	80	22	1,0
BOM 100/101	15772	rund	round	circulares	100	22	1,0
BOM 100/101	16022	4-Bogen	-curves	-arcos	100	22	1,0
BOM 100/101	16102	6-Bogen	-curves	-arcos	100	22	1,0
KRH 10	15712	rund	round	circulares	100	35	1,2
KRH 10	16042	4-Bogen	-curves	-arcos	100	35	1,2
KRH 12, KRT 120	15722	rund	round	circulares	120	35	1,2
KRH 12	16052	4-Bogen	-curves	-arcos	120	35	1,2
KRH 15	15732	rund	round	circulares	150	35	1,6
KRH 15	16062	4-Bogen	-curves	-arcos	150	35	1,6
KRH 20	15742	rund	round	circulares	200	40	2,2
KRH 20	16172	4-Bogen	-curves	-arcos	200	40	2,2
Champion CRA	15802	rund	round	circulares	100	8	1,3

Gegenschneidklingen siehe Seite 138
Counterknives see page 138
Contracuchillas véase página 138



Eastman



Maimin

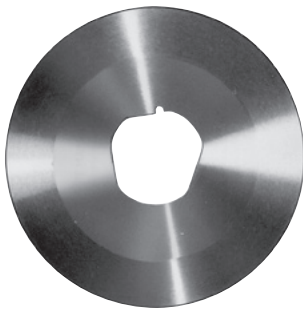

Wolf

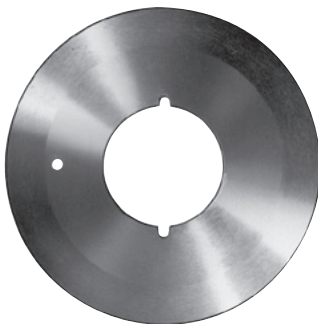

Rasor



Für Fabrikat For Machines Para producto	Messerform Shape of knives Forma de la cuchilla	Außen Ø Outer dia. Diámetro exterior	Bohrung Hole Espesor	Stärke Thickness Taladro
Type		mm	mm	mm
Eastman				
080 C 01-				
123 2 1/2"	Buzzaird 4-Bogen -curves -arcos	48,8	16	
147 2 1/4"	Chickadee rund round circulares	57	16	
26 3 1/2"		90	28	
59 4"	Falcon IV, Track, Robin rund round circulares	101,6	40	
101 5"	rund round circulares	127	40	
61 5 1/4"	548/355-61 rund round circulares	133,6	51	
39 6"	548/562/567 rund round circulares	152,6	51	
Maimin				
Minishear 2"	rund round circulares	50	16	
Minishear 2"	6-Bogen -curves -arcos	50	16	
Minishear 2"	8-Bogen -curves -arcos	50	16	
ACD 2 1/2"	rund round circulares	63,3	21,6	1,0
ACDC 4"	rund round circulares	102	40	1,0
ACDC 5"	rund round circulares	127	40	1,2
ACDC 5 1/4"	rund round circulares	133,5	50,8	1,3
ACDC 6"	rund round circulares	152,5	58,2	1,4
ACDC 7"	rund round circulares	178		
Suprena				
M702	rund round circulares	50	16	
M700	6-Bogen -curves -arcos	50	16	
M703	8-Bogen -curves -arcos	50	16	
R742	rund round circulares	80	22	
R740	8-Bogen -curves -arcos	80	22	
R1512	rund round circulares	100	22	
R1514	4-Bogen -curves -arcos	100	22	
R1513	6-Bogen -curves -arcos	100	22	
Wolf				
PUP 25260	4-Bogen -curves -arcos	52,5	17,6	1,0
SRN 2 1/2"	rund round circulares	64		1,0
Clipper 4"	23 einfasig rund round circulares	102	31,75	1,0
Clipper 4"	23 zweifasig rund round circulares	102	31,75	1,0
Clipper 4 3/4"	22 rund round circulares	121	42,5	1,0
Blazer 5 1/4"	21 rund round circulares	134	42,5	1,0
SLIM JIM 5 1/4"	24 rund round circulares	134	50	1,0
Blazer 6"	16 rund round circulares	153	40	1,2
Blazer-0 6"	18 rund round circulares	153	50,8	1,2
Blazer 7"	rund round circulares	178	50,8	1,4
Blazer-0 8"	rund round circulares	203	50,8	1,4
BIG-0 10"	rund round circulares	254	50,8	1,7
Diverse				
KM RS 100	rund round circulares	100	21	
KM RS 100 OCTA	8-Bogen -curves -arcos	100	21	
Rasor Extra 86 C	rund round circulares	86	22,4	
Rasor Extra D 100 C	rund round circulares	100	22,4	
Rasor Extra D 100 S	4-Bogen -curves -arcos	100	22,4	
SULEE Modell 260	=Hoogs Z+St rund round circulares	110		
Miniroller	4-Bogen -curves -arcos	110	25x10x5	
Secat	rund round circulares	67	22,4	1,0
Secat	10-Kant sided cantos	67	22,4	1,0

Weitere Kreismesser fertigen wir nach Muster oder Zeichnung
We produce further knives according to sample or drawing
Producimos más cuchillas circulares según muestra o dibujo

Alle Messer sind auch in HSS verfügbar
All knives are available in High-Speed-Steel
Todos las cuchillas también en acero rápido de alto rendimiento



Bullmer

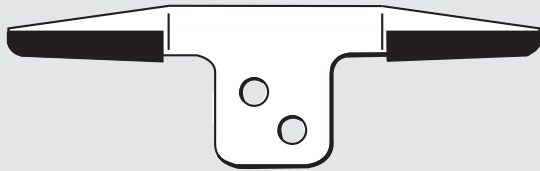

014694



014245

Hoogs



UM-5

501-138-UM-5 Klasse ST-1
 200-130-UM-5 Klasse ZN-ZVN
 512-110-UM-5 Klasse ST 565



UM-6

501-135-UM 6
 Klasse ST 2000 / 5000

Kuris



02 257

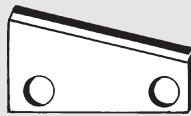

22 219 (CT)

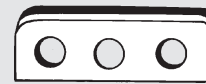

31 391 (CT)



25 208 (CT)
 Suprema M 460 / 706



30 785 (CT)
 Suprema M 456, M 458



Für alle Bandmesser-Zuschneidemaschinen
z.B. Kuris, Hoogs, Bullmer, Wastema, Hitaka,
CKS, NCA, Takaoka usw.
10–20 mm breit,
0,45 mm stark,
in verschiedenen Schlifffarten
(siehe unten).

For all band knife cutting machines, e.g.
Kuris, Hoogs, Bullmer, Wastema, Hitaka,
CKS, NCA, Takaoka etc.
10–20 mm wide
0,45 mm thick
in various grinding versions
(see below).

Para todas las máquinas cortadoras
de cuchilla cinta p.e. Kuris, Hoogs, Bullmer,
Wastema, Hitaka, CKS, NCA, Takaoka etc.
Ancho 10–20 mm,
espesor 0,45 mm
varios afilados
(véase abajo).

Hergestellt aus erstklassigem Material,
lieferbar als Meterware oder in Endloslängen
(Fixlängen).

Manufactured of first-class material,
available in metrages or endless length
(fix length)

Hechas de materiales de primera clase, de
ser entragadas por metro o en largos conti-
nuos (largos fijos).

glatt
smooth
liso

gezahnt
serrated
dentado

gezahnt 2,5 mm
serrated 2,5 mm
dentado 2,5 mm

konkav
concave
cóncavo

konvex
convex
convexo

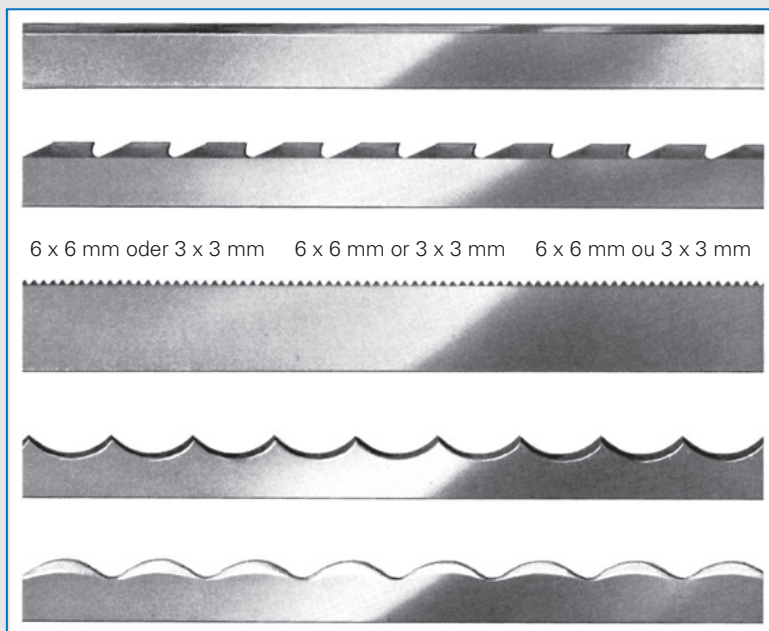

Doppelte Wate
Double bevel
Biselado doble



Vierfach Wate
Four bevels
Biselado cuádruplo

Gebräuchliche Abmessungen: glatt, doppelte Wate
Usual dimensions: smooth, double bevel
Dimensiones en uso: liso, biselado doble

2400 x 10 x 0.45	3605 x 10 x 0.45	4200 x 10 x 0.45	4810 x 10 x 0.45
2430 x 10 x 0.45	3680 x 10 x 0.45	4210 x 10 x 0.45	4850 x 10 x 0.45
2450 x 10 x 0.45	3700 x 10 x 0.45	4210 x 15 x 0.45	4850 x 15 x 0.45
2880 x 10 x 0.45	3720 x 10 x 0.45	4240 x 10 x 0.45	4900 x 10 x 0.45
2900 x 10 x 0.45	3750 x 10 x 0.45	4250 x 10 x 0.45	4920 x 10 x 0.45
2945 x 10 x 0.45	3760 x 10 x 0.45	4350 x 10 x 0.45	4920 x 15 x 0.45
3000 x 10 x 0.45	3840 x 10 x 0.45	4400 x 10 x 0.45	5030 x 10 x 0.45
3050 x 10 x 0.45	3850 x 10 x 0.45	4450 x 10 x 0.45	5050 x 10 x 0.45
3100 x 10 x 0.45	3860 x 10 x 0.45	4460 x 10 x 0.45	5070 x 10 x 0.45
3100 x 15 x 0.45	3870 x 10 x 0.45	4500 x 10 x 0.45	5150 x 10 x 0.45
3120 x 10 x 0.45	3880 x 10 x 0.45	4530 x 10 x 0.45	5200 x 10 x 0.45
3150 x 10 x 0.45	3900 x 10 x 0.45	4550 x 10 x 0.45	5207 x 12 x 0.45
3240 x 10 x 0.45	3900 x 15 x 0.45	4550 x 15 x 0.45	5210 x 10 x 0.45
3300 x 10 x 0.45	3950 x 10 x 0.45	4555 x 10 x 0.45	5230 x 10 x 0.45
3360 x 10 x 0.45	3960 x 10 x 0.45	4560 x 10 x 0.45	5270 x 10 x 0.45
3380 x 10 x 0.45	4020 x 10 x 0.45	4600 x 10 x 0.45	5280 x 10 x 0.45
3400 x 10 x 0.45	4040 x 10 x 0.45	4620 x 10 x 0.45	5285 x 10 x 0.45
3420 x 10 x 0.45	4050 x 10 x 0.45	4650 x 10 x 0.45	5300 x 10 x 0.45
3460 x 10 x 0.45	4080 x 10 x 0.45	4690 x 10 x 0.45	5300 x 12 x 0.45
3470 x 10 x 0.45	4094 x 10 x 0.45	4700 x 10 x 0.45	5300 x 15 x 0.45
3480 x 10 x 0.45	4100 x 10 x 0.45	4745 x 10 x 0.45	5500 x 10 x 0.45
3500 x 10 x 0.45	4100 x 12 x 0.45	4750 x 10 x 0.45	5800 x 15 x 0.45
3530 x 10 x 0.45	4115 x 12 x 0.45	4750 x 12 x 0.45	5840 x 10 x 0.45
3540 x 10 x 0.45	4120 x 10 x 0.45	4750 x 15 x 0.45	6040 x 10 x 0.45
3550 x 10 x 0.45	4130 x 10 x 0.45	4800 x 10 x 0.45	
3600 x 10 x 0.45	4150 x 10 x 0.45	4800 x 15 x 0.45	



Die Schmirgelschnur ist: Features of the abrasive cord:

- flexibel / flexible
- abriebfest / resistant to abrasion
- verschleißarm / wear resisting
- geruchsneutral / odourless
- bruchfest / break-proof
- gleichmäßig im Durchmesser
constant diameter

			Abrasive cords Standard Schmirgelschnur Standard cord		Silicon Carbide cords Feinere Struktur finer structure		Polisher cords zum Polieren for polishing		Oxyd Polisher cords zum Feinstpolieren for finest polishing	
Ø mm	Ø Zoll/Inch		Bestell-Nr. Order No.	Körnung Grain	Bestell-Nr. Order No.	Körnung Grain	Bestell-Nr. Order No.	Körnung Grain	Bestell-Nr. Order No.	Körnung Grain
Rollen/Spools 15 m:										
66	0,3	0,012			1SC/15	280	1PC/15	280		
60	0,4	0,015	2AC/15	280	2SC/15	280	2PC/15	280		
55	0,5	0,019	3AC/15	240	3SC/15	240	3PC/15	280	3OX/15	Oxyd
54HS	0,6	0,023	4AC/15	240	4SC/15	240	4PC/15	280	4OX/15	Oxyd
	0,7	0,027	5AC/15	240	5SC/15	240	5PC/15	280	5OX/15	Oxyd
54	0,8	0,031	7AC/15	180	7SC/15	180	7PC/15	280	7OX/15	Oxyd
53	1,0	0,039	8AC/15	180	8SC/15	180	8PC/15	280	8OX/15	Oxyd
	1,2	0,047	12AC/15	150	12SC/15	150	12PC/15	280	12OX/15	Oxyd
52/51	1,4	0,055	14AC/15	150	14SC/15	150	14PC/15	280	14OX/15	Oxyd
50	1,8	0,071	18AC/15	120	18SC/15	120	18PC/15	280	18OX/15	Oxyd
49	2,1	0,082	21AC/15	120	21SC/15	120	21PC/15	280		

Rollen/Spools 50 m: (1,4 und 1,8 mm Ø = 25 m)

66	0,3	0,012			1SC/50	280				
60	0,4	0,015	2AC/50	280	2SC/50	280	2PC/50	280		
55	0,5	0,019	3AC/50	240	3SC/50	240	3PC/50	280		
54HS	0,6	0,023	4AC/50	240			4PC/50	280		
	0,7	0,027	5AC/50	240			5PC/50	280		
54	0,8	0,031	7AC/50	180	7SC/50	180	7PC/50	280		
53	1,0	0,039	8AC/50	180	8SC/50	180				
	1,2	0,047	12AC/25	150						
52/51	1,4	0,055	14AC/25	150						
50	1,8	0,071								

Rollen/Spools 15 m Abrasive Tapes (Band):

Breite/ width mm		inch		M/Nr.		Bestell- Order-No.		Breite/ width mm		inch		M/Nr.		Bestell- Order No.	
2,5		3/32		56		25AT/15		6,0		8/32		59		60AT/15	