



In occasione del 70° anniversario della costituzione della Attilio Cornali, aperta come ditta individuale da Attilio Cornali nel 1931 con pochi collaboratori, ma tanta buona volontà e tenacia del titolare, siamo ora arrivati alla 3a generazione dei Cornali ed ora la Società si presenta come :

ATTILIO CORNALI S.r.l.

Con una sede in Milano per l'ufficio vendite ed amministrazione ed una seconda sede in Pantigliate nelle vicinanze di Milano con lo stabilimento per la produzione di pezzi di ricambio per macchine da cucire comuni e speciali ed una linea stiro denominata "Spidivap".

La Cornali è da più di 45 anni l'Agente Generale per l'Italia della Casa Schmetz - la più importante fabbrica di aghi per il cucito del continente europeo.

Un particolare ringraziamento e riconoscimento va alla nostra clientela ed ai nostri collaboratori che ci seguono e ci incoraggiano da molti anni. Grazie anche ai loro suggerimenti tecnici abbiamo avuto modo di progredire ed allargare sempre più la gamma dei nostri prodotti.

Con la speranza di fare sempre meglio e di più, presentiamo ora

il nostro nuovo catalogo

pensando di fare cosa gradita.

Questo Catalogo annulla tutte le precedenti edizioni. Avendo apportato notevoli cambiamenti con aggiunte ed eliminazioni di articoli, l'ordine numerico è così venuto spesso volte cambiato. Preghiamo i Sigg. Clienti, nelle loro richieste, di voler sempre indicare oltre il numero e la descrizione dell'articolo, anche la relativa pagina di Catalogo.



CONDIZIONI DI VENDITA

- L'imballo, il trasporto e le eventuali spese di tratta sono fatturati al costo.
- La Ditta non è responsabile in caso di ritardata consegna, di perdita della merce, e si riserva di annullare gli ordini senza indicarne i motivi e senza obbligo di rifusione di danni.
- Non si accettano reclami trascorsi otto giorni dal ricevimento della merce.
- La merce viaggia a rischio e pericolo del committente.
- Non si accettano resi se non autorizzati e franchi di porto.
- In caso di contestazione è competente il Foro di Milano anche se il pagamento è pattuito contro tratta o presso la sede del compratore.
- Non si rilasciano quietanze se non accompagnate dalle relative fatture.
- Le eventuali diverse condizioni espresse dal cliente sugli ordini non saranno riconosciute valide se non da noi accettate.
- I prezzi sono oggetti a variazione senza obbligo di preavviso.
- I ns. prezzi si intendono per merce resa franco ns. magazzino.

Indice

	Pagina
Sezione 1 Piedini	1
Sezione 2 Articoli vari	45
Sezione 3 Apparecchiature	87
Sezione 4 Ricambi per Adler	119
Sezione 5 Ricambi per Brother	129
Sezione 6 Ricambi per Durkopp	131
Sezione 7 Ricambi per Juki	136
Sezione 8 Ricambi per Lewis - Kansai	147
Sezione 9 Ricambi per Mauser	157
Sezione 10 Ricambi per Merrow	164
Sezione 11 Ricambi per Necchi	165
Sezione 12 Ricambi per Pegasus	169
Sezione 13 Ricambi per Pfaff	177
Sezione 14 Ricambi per Reece	205
Sezione 15 Ricambi per Rimoldi	206
Sezione 16 Ricambi per Singer	211
Sezione 17 Ricambi per Siruba	217
Sezione 18 Ricambi per Union Special	219
Sezione 19 Ricambi per W. G.	228
Sezione 20 Ricambi per Yamato	234
Sezione 21 Crochet per macchine Blindstich e guide	251
Sezione 22 Affilatrici e accessori	255
Sezione 23 Navette - Crochet	259
Sezione 24 Sezione Viti	275

Tabella comparativa

pollici - millimetri					
$1/64''$	0.40 mm	$25/64''$	9.91 mm	$29/32''$	23.02 mm
$1/32''$	0.79 mm	$13/32''$	10.32 mm	$15/16''$	23.81 mm
$3/64''$	1.19 mm	$27/64''$	10.72 mm	$31/32''$	24.61 mm
$1/16''$	1.59 mm	$7/16''$	11.11 mm	$63/64''$	25.00 mm
$5/64''$	1.98 mm	$29/64''$	11.51 mm	1"	25.4 mm
$3/32''$	2.38 mm	$15/32''$	11.91 mm	$1\ 1/8''$	28.58 mm
$7/64''$	2.78 mm	$31/64''$	12.30 mm	$1\ 1/4''$	31.75 mm
$1/8''$	3.18 mm	$1/2''$	12.70 mm	$1\ 3/8''$	34.10 mm
$9/64''$	3.57 mm	$33/64''$	13.10 mm	$1\ 1/2''$	38.10 mm
$5/32''$	3.97 mm	$17/32''$	13.49 mm	$1\ 3/4''$	44.45 mm
$11/64''$	4.37 mm	$35/64''$	13.89 mm	2"	50.8 mm
$3/16''$	4.76 mm	$9/16''$	14.29 mm	$2\ 1/4''$	57.15 mm
$13/64''$	5.16 mm	$37/64''$	14.68 mm	$2\ 1/2''$	63.50 mm
$7/32''$	5.56 mm	$19/32''$	15.08 mm	$2\ 3/4''$	69.85 mm
$7/64''$	5.95 mm	$39/64''$	15.48 mm	3"	76.2 mm
$1/44''$	6.35 mm	$5/8''$	15.88 mm	$3\ 1/4''$	82.55 mm
$17/64''$	6.75 mm	$21/32''$	16.67 mm	$3\ 1/2''$	88.90 mm
$9/32''$	7.14 mm	$11/16''$	17.49 mm	$3\ 3/4''$	95.25 mm
$19/64''$	7.54 mm	$23/32''$	18.26 mm	4"	101.60 mm
$5/16''$	7.94 mm	$3/4''$	19.05 mm	$4\ 1/4''$	107.95 mm
$21/64''$	8.33 mm	$25/32''$	19.84 mm	$4\ 1/2''$	114.30 mm
$11/32''$	8.73 mm	$13/16''$	20.64 mm	$4\ 3/4''$	120.65 mm
$23/64''$	9.13 mm	$27/32''$	21.43 mm	5"	127.00 mm
$3/8''$	9.53 mm	$7/8''$	22.23 mm	6"	152.40 mm

Piedini

GAMBO BASSO

- Piedini domestici
- Piedini orlatori
- Piedini compensatori

GAMBO ALTO

- Piedini per cerniere
- Piedini premistoffa
- Piedini scanalati
- Piedini compensatori
- Piedini arricciatori
- Piedini con guida
- Piedini guida nastro
- Piedini tagliafilo
- Piedini per bordatori
- Piedini per orlatori
- Piedini per velluto
- Piedini e apparecchiature in teflon

PIEDINI DOMESTICI - GAMBO BASSO



113A



1198A



301A



160A



166A



B1195A



319A



B722A



B1005A



1196A

N. di catalogo N. di descrizione	N. Originale	Descrizione
113A		Piedino snodato larghezza suola 12 mm
1198A		Piedino snodato suola teflon
301A		Piedino ovattatore
160A		Piedino snodato zig-zag larghezza 14mm
166A		Piedino snodato per ornamento
B1195A		Piedino snodato zig-zag suola teflon
319A		Piedino arricciatore
B722A		Piedino crespatore snodato a 3 - 5 - 7 - 9 pieghe
B1005A		Piedino cordonatore sinistro, destro, snodato e regolabile
1196A		Piedino cordonatore sinistro, destro, con suola teflon

PIEDINI ORLATORI - GAMBO BASSO



252A



220A

Misure:
mm 2
mm 2,5
mm 3
mm 4
mm 5



200A

Misure:
mm 1
mm 1,5
mm 2
mm 3
mm 4
mm 5



221A

Misure:
mm 2
mm 2,5
mm 3
mm 4



225A

Misure:
mm 1,5
mm 3

N. di catalogo N. di descrizione	N. Originale	Descrizione
252A		Piedino ribattitore 4 mm
200A		Piedino orlatore fisso
220A		Piedino orlatore snodato
221A		Piedino orlatore snodato zig-zag
225A		Piedino rotolatore

PIEDINI COMPENSATORI DOMESTICI - GAMBO BASSO



B1174A1.5



B1174A3



B1174A4



B1174A5



B1174A6

N. di catalogo N. di descrizione	N. Originale	Descrizione
B1174A1,5		Piedino compensatore gambo basso 1,5 mm
B1174A3		Piedino compensatore gambo basso 3 mm
B1174A4		Piedino compensatore gambo basso 4 mm
B1174A5		Piedino compensatore gambo basso 5 mm
B1174A6		Piedino compensatore gambo basso 6 mm

PIEDINI VARI - GAMBO ALTO

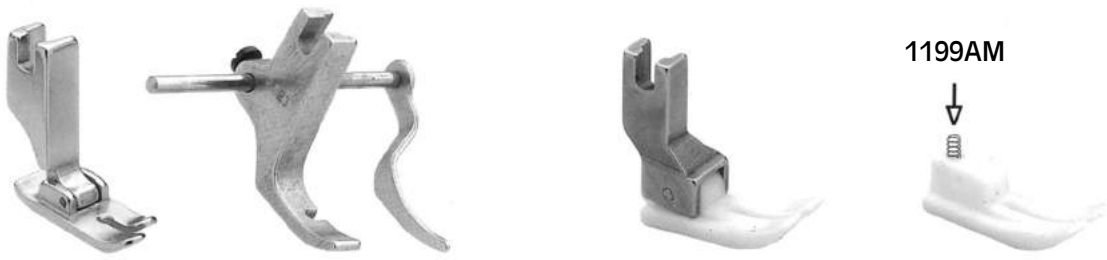

501A

704A

1199A

1199AM



1199AS



522A



526A



1195A



722A



1005A



1197A

N. di catalogo N. di descrizione	N. Originale	Descrizione
501A		Piedino cucitura dritta
704A		Piedino ovattatore fisso
1199A		Piedino suola tutto teflon
1199AS		Soletta teflon x 1199 A
1199AM		Molla x soletta 1199 A
522A		Piedino cucitura zig-zag
526A		Piedino per ornamento
1195A		Piedino con soletta teflon zig-zag
722A		Piedino crespatore da 3 a 9 pieghe
1005A	4351	Piedino cordonatore sinistro - destro
1197A		Piedino cordonatore sinistro - destro soletta teflon

PIEDINI ORLATORI - GAMBO ALTO



600A

Misure:
 mm 1 mm 1,5
 mm 2 mm 3
 mm 4 mm 5
 mm 6 mm 7
 mm 8 mm 9



620A

Misure:
 mm 2 mm 2,5
 mm 3 mm 4
 mm 5

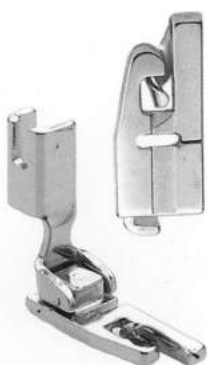

621A

Misure:
 mm 2 mm 2,5
 mm 3 mm 1
 mm 4



622A

Misure:
 mm 1,5
 mm 3

N. di catalogo N. di descrizione	N. Originale	Descrizione
600A	86540	Piedino orlatore fisso
620A		Piedino orlatore snodato
621A		Piedino orlatore snodato zig-zag
622A		Piedino rotolatore snodato

PIEDINI PER CERNIERE



1001A



1002A



1004A



1003A



S1001A



S1002A



S1004A



S1003A

N. di catalogo N. di descrizione	N. Originale	Descrizione
1001A	31358N	Piedino cordonatore sinistro stretto fisso
1002A	31358W	Piedino cordonatore sinistro largo fisso
1003A	12435W	Piedino cordonatore destro largo fisso
1004A	12435N	Piedino cordonatore destro stretto fisso
S1001A	31358HN	Piedino cordonatore sinistro stretto snodato
S1002A	31358HW	Piedino cordonatore sinistro largo snodato
S1003A	12435HW	Piedino cordonatore destro largo snodato
S1004A	12435HN	Piedino cordonatore destro stretto snodato

PIEDINI PER CERNIERE



1006A



1007A



1008A



1009A



T1009A



D1009A



P1009A



1013A



1015A

N. di catalogo N. di descrizione	N. Originale	Descrizione
1006A	165010	Piedino cerniere regolatore fisso
1007A	40322	Piedino cerniere con foro fisso
1008A	40322CS	Piedino cerniere con fessura fisso
1009A	40322SH	Piedino cerniere regolatore snodato
T1009A	40322HT	Piedino cerniere regolatore snodato suola in teflon
D1009A		Piedino cerniere tipo Durkopp KL212
P1009A		Piedino cerniere tipo Pfaff KL461/481
1013A		Piedino cerniere tipo Necchi KL881
1015A		Piedino cerniere tipo Necchi KL831

PIEDINI PER CERNIERE - VARI - TEFLON



N1001A



N1004A



T1001A



P1001A



P1004A



T1002A



P1002A



P1003A



T1003A



D1001A



D1004A



T1004A

N. di catalogo N. di descrizione	N. Originale	Descrizione
N1001A		1/2 Piedino destro per NE 881
N1004A		1/2 Piedino sinistro per NE 881
P1001A		1/2 Piedino destro per PFAFF 461 stretto
P1002A		1/2 Piedino destro per PFAFF 461 largo
P1003A		1/2 Piedino sinistro per PFAFF 461 largo
P1004A		1/2 Piedino sinistro per PFAFF 461 stretto
D1001A		1/2 Piedino destro per DK 212
D1004A		1/2 Piedino sinistro per DK 212
T1001A		Piedino cordonatore sinistro stretto teflon
T1002A		Piedino cordonatore sinistro largo teflon
T1003A		Piedino cordonatore destro largo teflon
T1004A		Piedino cordonatore destro stretto teflon

PIEDINI PER CERNIERE INVISIBILI



S518



S518N

PIEDINI AD ANELLI



1166A



1167A



1167AA

N. di catalogo N. di descrizione	N. Originale	Descrizione
S518	S518	Piedino per cerniere punto invisibile
S518N	S518N	Piedino per cerniere punto invisibile con prua stretto
1166A		Piedino teflon ad anelli
1167A		Piedino con anelli in nylon
1167AA		Anelli separati per piedino 1167A

PIEDINI CON SALVADITO VARI



SD1001A



SD1002A



SD1003A



SD1004A



SD1009A



SD1010A



SD1018A



SD1019A



SD518

N. di catalogo N. di descrizione	N. Originale	Descrizione
SD1001A		Piedino cordonatore sinistro stretto snodato con salvadito
SD1002A		Piedino cordonatore sinistro largo snodato con salvadito
SD1003A		Piedino cordonatore destro largo snodato con salvadito
SD1004A		Piedino cordonatore destro stretto snodato con salvadito
SD1009A		Piedino cerniere regolare snodato con salvadito
SD1010A		Piedino cerniere snodato con salvadito
SD1018A		Piedino snodato con suola regolare con salvadito
SD1019A		Piedino snodato con suola larga con salvadito
SD518		Piedino cerniere punto invisibile

PIEDINI PREMISTOFFA



1010A



1011A



1012A



1014A



1016A



1017A

N. di catalogo N. di descrizione	N. Originale	Descrizione
1010A	165010H	Piedino per cerniere - snodato con suola inclinata
1011A	142058	Piedino per cerniere - snodato con suola larga
1012A	12142	Piedino semplice con suola regolare
1014A	12144	Piedino semplice con doppia suola uguale
1016A	25983	Piedino semplice con suola dimezzata
1017A	142058N	Piedino snodato con suola stretta

PIEDINI PREMISTOFFA



1018A



1019A



1020A



1021A



1022A



1038A

N. di catalogo N. di descrizione	N. Originale	Descrizione
1018A	24983	Piedino snodato con suola regolare
1019A	19336	Piedino snodato con suola larga
1020A	127233	Piedino snodato con suola molto larga
1021A	12144H	Piedino snodato con doppia suola uguale
1022A	S710	Piedino snodato con suola per nylon
1038A		Piedino snodato regolare con salvadita

PIEDINI SCANALATI

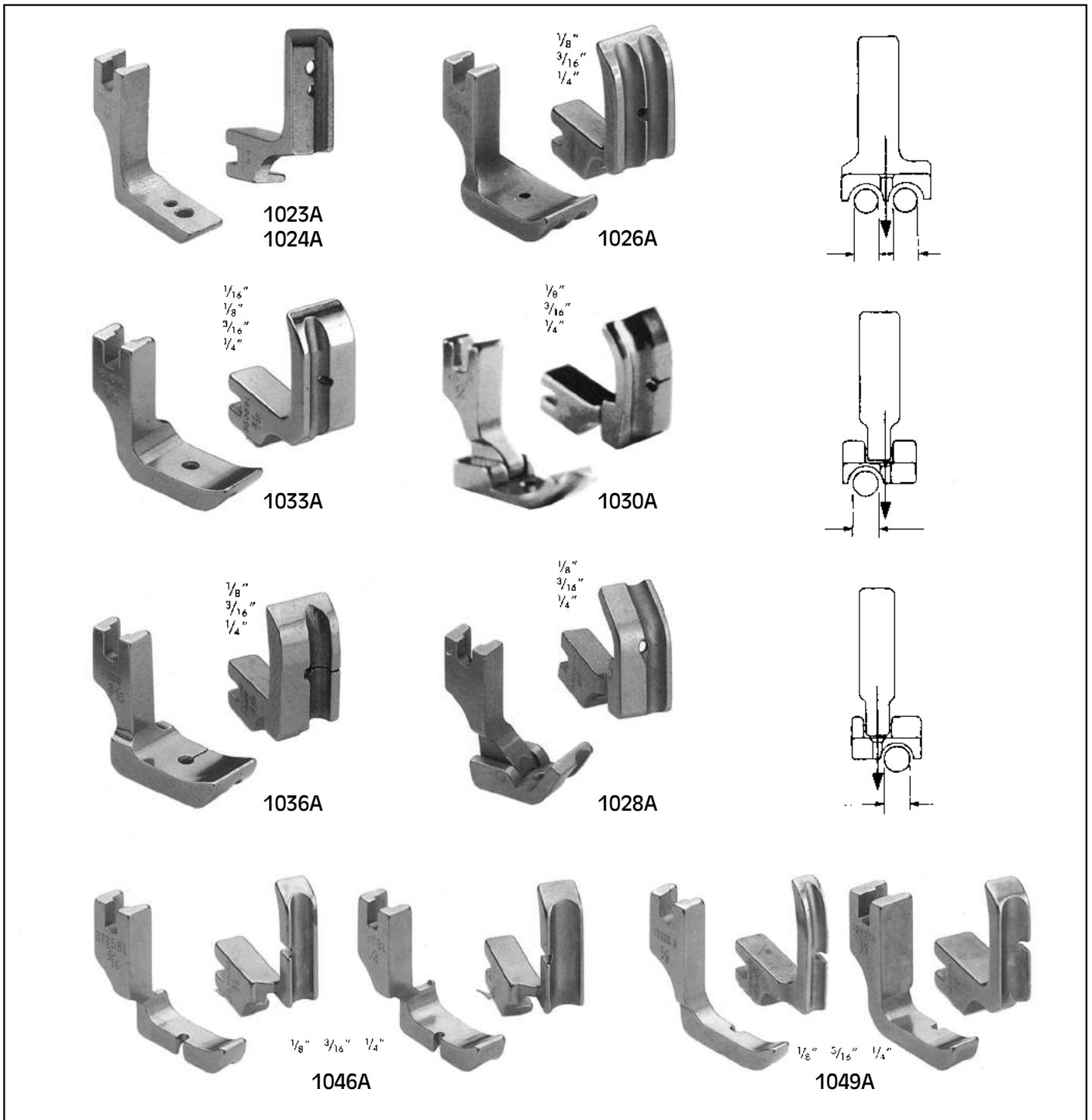

N. di catalogo N. di descrizione	N. Originale	Descrizione
1023A	26650R	Piedino scanalato fisso destro
1024A	26650L	Piedino scanalato fisso sinistro
1026A	26650DG - S701	Piedino con doppia scanalatura - fisso
1033A	36069L	Piedino fisso con suola scanalata sinistra
1030A	36069HL	Piedino snodato sinistro con suola scanalata inclinata
1036A	36069R	Piedino fisso con suola scanalata destra
1028A	36069HR	Piedino snodato destro con suola scanalata inclinata
1046A	12435R	Piedino cordonatore destro scanalato
1049A	31358L	Piedino cordonatore sinistro scanalato

PIEDINI ARRICCIATORI



1051A



1054A



1060A



1056A



1059A



1057A



1058A

N. di catalogo N. di descrizione	N. Originale	Descrizione
1051A	12828	Piedino arricciatore largo con scalino regolare
1054A	12828N	Piedino arricciatore stretto con scalino regolare
1060A	S207	Piedino arricciatore speciale
1056A	S950	Piedino regolabile con scalino alto e basso
1059A	S952	Piedino snodato con oscillazione regolabile
1057A	P5	Piedino arricciatore con inserimento nastro 3 mm
1058A	P5W	Piedino arricciatore con inserimento nastro 10 mm

PIEDINI CON GUIDA



1075A



1068A



1073A

Misure:

$1/32'' = \text{mm } 0,8$
 $1/16'' = \text{mm } 1,6$
 $1/8'' = \text{mm } 3,2$
 $3/16'' = \text{mm } 4,8$
 $1/4'' = \text{mm } 6,4$
 $5/16'' = \text{mm } 8,0$
 $3/8'' = \text{mm } 9,5$
 $1/2'' = \text{mm } 12,7$



1062A



1065A



1066A

Misure:

$1/32'' = \text{mm } 0,8$
 $1/16'' = \text{mm } 1,6$
 $3/32'' = \text{mm } 2,4$
 $1/8'' = \text{mm } 3,2$
 $3/16'' = \text{mm } 4,8$
 $1/4'' = \text{mm } 6,4$



1074A

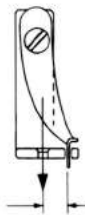

1078A

N. di catalogo N. di descrizione	N. Originale	Descrizione
1062A	12463	Piedino con guida a destra - misure da $1/16''$ a $1/2''$
1073A	35137	Piedino con guide regolabili destra e sinistra
1075A	S524	Piedino con guide regolabili destra e sinistra
1065A	L12463H	Piedino snodato con guida a sinistra - misure da $1/16''$ a $1/2''$
1066A	L12463HR	Piedino snodato con guida a destra - misure da $1/16''$ a $1/2''$
1074A	36465	Piedino con guida elastica da $1/32''$ a $1/4''$
1078A	S521	Piedino ovattatore - trapuntatore con guida destra e sinistra
1068A		Piedino snodato - guida regolabile

PIEDINI CON GUIDA NASTRO E PIEDINI PER VELLUTO



1069AD

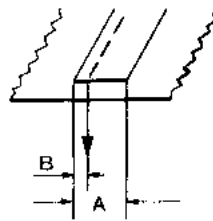

1069AS

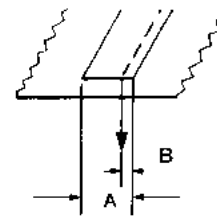

1069AC

Misure:
 $\frac{1}{8}$ " = mm 3,2
 $\frac{3}{16}$ " = mm 4,8
 $\frac{1}{4}$ " = mm 6,4
 $\frac{3}{8}$ " = mm 9,5
 $\frac{1}{2}$ " = mm 12,7



1076A



1077A



1071A



1072A

N. di catalogo N. di descrizione	N. Originale	Descrizione
1069AD	S10R	Piedino snodato con tubo a destra misure: da $\frac{1}{8}$ " a $\frac{3}{4}$ "
1069AC	S10C	Piedino snodato con tubo al centro misure: da $\frac{1}{8}$ " a $\frac{3}{4}$ "
1069AS	S10L	Piedino snodato con tubo a sinistra misure: da $\frac{1}{8}$ " a $\frac{3}{4}$ "
1071A	S533	Piedino con tubo guidanastro regolabile
1072A	S534	Piedino con tubo guidanastro regolabile - extra
1076A	S530S	Piedino per velluto con suola corta
1077A	S531L	Piedino per velluto con suola lunga

PIEDINI ORLATORI

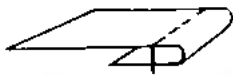

Misure:
1/4"

1090A

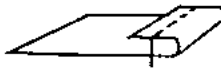

Misure:
1/4"

1091A



Misure:
1/4"

1092A

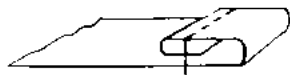

Misure:
1/32"
1/16"
1/8"
3/16"
1/4"

1094A

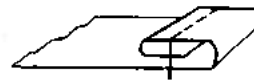

Misure:
1/32"
1/16"
1/8"
3/16"
1/4"

1095A

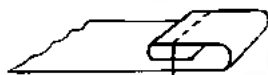

Misure:
1/32"
1/16"
1/8"
3/16"
1/4"

1096A



1093A

N. di catalogo N. di descrizione	N. Originale	Descrizione
1090A	490355	Piedino orlatore a piega semplice inferiore destra 1/4"
1091A	490357	Piedino orlatore a piega semplice superiore destra 1/4"
1092A	490356	Piedino orlatore a piega semplice inferiore sinistra 1/4"
1093A	H5020	Piedino orlatore a piega semplice per l'unione dei tessuti
1094A	490358	Piedino orlatore a piega doppia con palla per foulard e cravatte
1095A	490360	Piedino orlatore a piega doppia
1096A	490359	Piedino orlatore a piega doppia con molla: facilita il passaggio delle giunte o di doppi strati (es.: etichette)

PIEDINI PER BORDATORI



1079A



1081A



1100A



1101A



1102A



1103A



1097A



1098A



1099A

N. di catalogo N. di descrizione	N. Originale	Descrizione
1079A	S802	Piedino pesante con suola temperata - foro a sinistra
1081A	S804	Piedino molto pesante con suola con foro in centro
1100A		Piedino per bordatore tipo Pfaff - gambo basso zig-zag
1101A	7120	Piedino per bordatori tipo Pfaff - gambo basso
1102A	12142C	Piedino per bordatori
1103A	7105	Piedino per bordatori tipo Pfaff - gambo basso
1097A	R2	Piedino a rullo
1098A	SPK1	Placca per piedino a rulli
1099A	SPK2	Griffa zigrinata per piedini a rulli

PIEDINI PER ORLATORI E BORDATORI



1104A



1105A



1107A



1/2" = 13 mm

1108A



3/4" = 19 mm

1109A



1" = 25 mm

1110A



1/4" = 6 mm

1111A



1/2" = 13 mm

1112A



3/4" = 19 mm

1113A

N. di catalogo N. di descrizione	N. Originale	Descrizione
1104A	12144HLD	Piedino snodato con suola molto inclinata
1105A	S402	Piedino con suola temperata e rialzata
1107A	12144HLB	Piedino snodato con suola non temperata e rialzata
1108A	S542	Piedino per orlatori e bordatori da 1/2"
1109A	S542	Piedino per orlatori e bordatori da 1/4"
1110A	S542	Piedino per orlatori e bordatori da 1"
1111A	S538	Piedino stretto con guida per bordatori e orlatori max 1/4"
1112A	S539	Piedino medio con guida per bordatori e orlatori da 1/4" a 1/2"
1113A	S540	Piedino largo con guida per bordatori e orlatori da 3/4" e oltre

PIEDINI CON RASAFILO E RELATIVE APPARECCHIATURE



1082A



1083A



1084A



1085A



1086A

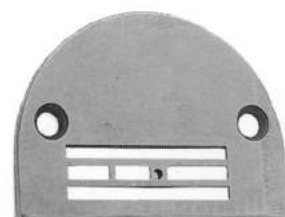

1087A

N. di catalogo N. di descrizione	N. Originale	Descrizione
1082A	24983TC	Piedino rasafilo
1083A	19336TC	Piedino rasafilo
1084A	S535	Piedino rasafilo (nuovo modello)
1085A	127260	Piedino rasafilo larga
1086A	147315	Griffa per piedino con rasafilo
1087A	147320	Placca per piedino con rasafilo

PIEDINI CON TEFLON E RELATIVA APPARECCHIATURA



1116A

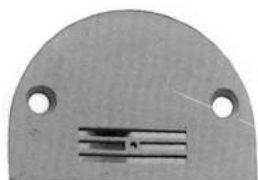

1117A



1118A



1119A

N. di catalogo N. di descrizione	N. Originale	Descrizione
1116A	46682T	Piedino snodato in teflon tipo Pfaff
1117A	52032LGT	Placca ago teflonata
1118A	52031	Griffa con denti zigrinati
1119A	52031R	Griffa con denti in gomma speciale

PIEDINI PER SINGER 107 W E 111 W



1125A



1126A



1127A



1128A



1129A



1130A

Misure:
 $\frac{1}{8}'' = \text{mm } 3,2$
 $\frac{3}{16}'' = \text{mm } 4,8$
 $\frac{1}{4}'' = \text{mm } 6,4$



1131A

N. di catalogo N. di descrizione	N. Originale	Descrizione
1125A	210569	Piedino snodato per Singer 107 W
1126A	S/107B	Piedino non temperato per Singer 107 W
1127A	S/107RB	Piedino non temperato con gradino per Singer 107 W
1128A	240148	Piedino normale per Singer 111 W
1129A	240149	Piedino interno per Singer 111 W
1130A	240548	Piedino per cordonare esterno per Singer 111 W
1131A	240549	Piedino per cordonare interno per Singer 111 W

PIEDINI SPECIALI PER SINGER 111 W, 100 E 112



1132A



1133A

Misure:
 $\frac{1}{8}$ " = mm 3,2
 $\frac{3}{16}$ " = mm 4,8
 $\frac{1}{4}$ " = mm 6,4
 $\frac{3}{8}$ " = mm 9,5



1134A

Misure:
 $\frac{1}{8}$ " = mm 3,2
 $\frac{3}{16}$ " = mm 4,8
 $\frac{1}{4}$ " = mm 6,4
 $\frac{3}{8}$ " = mm 9,5



1135A

Misure:
 $\frac{3}{16}$ " = mm 4,8
 $\frac{1}{4}$ " = mm 6,4
 $\frac{5}{16}$ " = mm 7,9
 $\frac{3}{8}$ " = mm 9,5
 $\frac{1}{2}$ " = mm 12,7
 $\frac{5}{8}$ " = mm 15,9
 $\frac{3}{4}$ " = mm 19,0
 $\frac{7}{8}$ " = mm 22,2
1" = mm 25,4
 $1\frac{1}{8}$ " = mm 28,6
 $1\frac{1}{4}$ " = mm 31,7
 $1\frac{1}{2}$ " = mm 38,1



1136A



Misure:
 $\frac{9}{16}$ " - $\frac{5}{8}$ " - $\frac{3}{4}$ " - 1"
 $1\frac{1}{4}$ " - $1\frac{1}{2}$ " - 2"



1137A

N. di catalogo N. di descrizione	N. Originale	Descrizione
1132A	22982	Piedino snodato per Singer 111 W
1133A	S560	Piedino per cordonare per Singer 111 W
1134A	S561	Piedino per cordonare per Singer 111 W
1135A	224178	Piedino snodato per Singer 112 W
1136A	210620	Gambo
1137A	S549	Suola separata per detto

PIEDINI CON TEFLON



1198A



B1195A



1195A



1196A



1197A



1143A



1116A

N. di catalogo N. di descrizione	N. Originale	Descrizione
1198A		Piedino teflon gambo basso
B1195A		Piedino teflon zig-zag gambo basso
1195A		Piedino teflon zig-zag gambo alto
1196A		Piedino per cerniere teflon gambo basso
1197A		Piedino per cerniere teflon gambo alto
1143A	43522	Piedino teflon Pfaff 138 zig-zag
1116A	46682	Piedino teflon Pfaff 134

PIEDINI CON TEFLON



E1199A



E1199AS



1199A



1199AS



1145A



1146A



1147A

N. di catalogo N. di descrizione	N. Originale	Descrizione
1199A		Piedino con suola tutto teflon
1199AS		Suola teflon separata per detto
1199AM		Molla per detto
1145A		Piedino teflon per Durkopp 212
1146A	955301	Piedino teflon per Necchi 881
1147A	30715	Piedino teflon per Necchi 831
E1199A	T35	Piedino con suola tutto teflon economico
E1199AS		Piedino teflon separata per detto

PIEDINI PER NECCHI



1150A



1151A



1152A



1153A



1154A



1155A



1156A



1157A



1158A



1159A

Misure:
4,8 mm
6,4 mm

N. di catalogo N. di descrizione	N. Originale	Descrizione
1150A	956099	Piedino zig-zag Necchi 750
1151A	110409	Piedino zig-zag Necchi RZl
1152A	961761	Piedino Necchi 881
1153A	961788	Piedino Necchi 881
1154A	956653	Piedino Necchi 800
1155A	956517	Piedino Necchi 885
1156A	42465L	Piedino Necchi 831 - largo
1157A	42465S	Piedino Necchi 831 - stretto
1158A		Piedino 2 aghi Necchi 921 da 3,2 a 20 mm
1159A		Piedino 2 aghi Necchi 971 da 4,8 a 6,4 mm

PIEDINI PER PFAFF - DURKOPP - JUKI



E1160A



E1161A



1162A



1163A



1164AD



1165A



B1524-012-0A0



1158A

DISTANZA AGHI			
3,2 mm	3,6 mm	4 mm	4,8 mm
6 mm	6,4 mm	8 mm	10 mm
12 mm	14 mm	16 mm	20 mm

N. di catalogo N. di descrizione	N. Originale	Descrizione
1160A	46682	Piedino Pfaff 134
1161A	26653	Piedino Pfaff 134
1162A	43522	Piedino Pfaff 138
1163A	51742	Piedino Pfaff 463 da 1,6 e 2,2 mm
1165A		Piedino Pfaff 461 - 481 - Durkopp 272
1158A		Piedino Pfaff 142 da 3,2 a 20 mm
1164AD		Piedino Durkopp 212
B1524-012-0A0		Piedino Juki

PIEDINI COMPENSATORI DESTRI



1173A



1174A

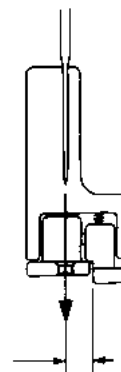

1175A



1176A



1177A



1178A



1179A

1174AM 

1175AM 

1176AM 



1174AV



1157AV



1176AV

$1/32''$	=	0,8 mm
$1/16''$	=	1,6 mm
$1/8''$	=	3,2 mm
$3/16''$	=	4,8 mm
$1/4''$	=	6,4 mm
$5/16''$	=	8,0 mm

N. di catalogo N. di descrizione	N. Originale	Descrizione
1173A	21R	Piedino compensatore $1/32''$ destro
1174A	210R	Piedino compensatore $1/32''$ destro stretto
1175A	211R	Piedino compensatore $1/16''$ destro
1176A	212R	Piedino compensatore $1/8''$ destro
1177A	213R	Piedino compensatore $3/16''$ destro
1178A	214R	Piedino compensatore $1/4''$ destro
1179A		Piedino compensatore destro da 7 - 8 - 9 - 10 - 12 mm
1174AM		Molla per piedino compensatore stretto
1175AM		Molla per piedino compensatore medio
1176AM		Molla per piedino compensatore lungo
1174AV		Vite per piedino compensatore stretto
1175AV		Vite per piedino compensatore medio
1176AV		Vite per piedino compensatore largo

PIEDINI COMPENSATORI SINISTRI E DOPPI



1180A



1181A



1182A

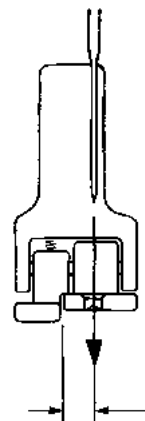

1183A



1184A



1185A



1186A



1187A



1188A



1189A

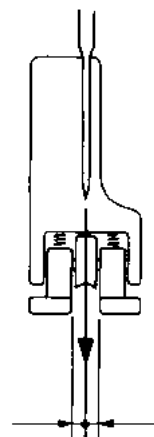

N. di catalogo N. di descrizione	N. Originale	Descrizione
1180A	22L	Piedino compensatore 1/32" sinistro
1181A	220L	Piedino compensatore 1/32" stretto sinistro
1182A	221L	Piedino compensatore 1/16" sinistro
1183A	222L	Piedino compensatore 1/8" sinistro
1184A	223L	Piedino compensatore 3/16" sinistro
1185A	224L	Piedino compensatore 1/4" sinistro
1186A	23	Piedino compensatore doppio 1/32"
1187A	230	Piedino compensatore doppio 1/32" stretto
1188A	231	Piedino compensatore doppio 1/16"
1189A	230 ZZ	Piedino compensatore doppio zig-zag

PIEDINI COMPENSATORI DESTRI "YS"



YS-21R



YS-210R



YS-211R



YS-211N



YS-212R



YS-213R



YS-214R



YS-215R



YS-216R

N. di catalogo N. di descrizione	N. Originale	Descrizione
YS-21R		Piedino compensatore 1/32" destro largo
YS-210R		Piedino compensatore 1/32" destro stretto
YS-211R		Piedino compensatore 1/16" destro
YS-211N		Piedino compensatore 1/16" destro stretto
YS-212R		Piedino compensatore 1/8" destro
YS-213R		Piedino compensatore 3/16" destro
YS-214R		Piedino compensatore 1/4" destro
YS-215R		Piedino compensatore 5/16" destro
YS-216R		Piedino compensatore 3/8" destro

PIEDINI COMPENSATORI SINISTRI "YS"



YS-22L



YS-220L



YS-221L



YS-221N



YS-222L



YS-223L



YS-224L

N. di catalogo N. di descrizione	N. Originale	Descrizione
YS-22L		Piedino compensatore 1/32" sinistro largo
YS-220L		Piedino compensatore 1/32" sinistro
YS-221L		Piedino compensatore 1/16" sinistro
YS-221N		Piedino compensatore 1/16" sinistro stretto
YS-222L		Piedino compensatore 1/8" sinistro
YS-223L		Piedino compensatore 3/16" sinistro
YS-224L		Piedino compensatore 1/4" sinistro

PIEDINI COMPENSATORI DESTRI ECONOMICI



E1173A21R



E1174A210R



E1175A211R



E1175A211N



E1176A212R



E1177A213R



E1178A214R



E1179A7



E1179A8



E1179A9



E1179A12

N. di catalogo N. di descrizione	N. Originale	Descrizione
E1173A21R		Piedino compensatore 1/32" destro economico
E1174A210R		Piedino compensatore 1/32" destro stretto economico
E1175A211R		Piedino compensatore 1/16" destro economico
E1175A211N		Piedino compensatore 1/16" destro stretto economico
E1176A212R		Piedino compensatore 1/8" destro economico
E1177A213R		Piedino compensatore 3/16" destro economico
E1178A214R		Piedino compensatore 1/4" destro economico
E1179A7		Piedino compensatore 7 mm destro economico
E1179A8		Piedino compensatore 8 mm destro economico
E1179A9		Piedino compensatore 9 mm destro economico
E1179A12		Piedino compensatore 12 mm destro economico

PIEDINI COMPENSATORI SINISTRI ECONOMICI



E1173A22L



E1174A220L



E1175A221L



E1175A221N



E1176A222L



E1177A223L



E1178A224L

N. di catalogo N. di descrizione	N. Originale	Descrizione
E1173A22L		Piedino compensatore 1/32" sinistro economico
E1174A220L		Piedino compensatore 1/32" sinistro stretto economico
E1175A221L		Piedino compensatore 1/16" sinistro economico
E1175A221N		Piedino compensatore 1/16" sinistro stretto economico
E1176A222L		Piedino compensatore 1/8" sinistro economico
E1177A223L		Piedino compensatore 3/16" sinistro economico
E1178A224L		Piedino compensatore 1/4" sinistro economico

PIEDINI COMPENSATORI CON SALVADITO DESTRI E SINISTRI



SD210R



SD211R



SD212R



SD213R



SD214R



SD22L



SD220L



SD221L

N. di catalogo N. di descrizione	N. Originale	Descrizione
SD210R		Piedino compensatore destro con salvadito 1/32"
SD211R		Piedino compensatore destro con salvadito 1/16"
SD212R		Piedino compensatore destro con salvadito 1/8"
SD213R		Piedino compensatore destro con salvadito 3/16"
SD214R		Piedino compensatore destro con salvadito 1/4"
SD22L		Piedino compensatore sinistro con salvadito 1/32" largo
SD220L		Piedino compensatore sinistro con salvadito 1/32"
SD221L		Piedino compensatore sinistro con salvadito 1/16"

PIEDINI COMPENSATORI DESTRI SUOLA TEFLON



T1173A



T1175AN



T1175A



T1176A



T1177A



T1178A



Suola
ricambio

COMPENSATORI DESTRI PER MAGLINA



M1173A



M1175A



M1176A



M1177A



M1178A

N. di catalogo N. di descrizione	N. Originale	Descrizione
T1173A	21R	Piedino compensatore 1/32" destro teflon
T1175AN		Piedino compensatore 1/16" destro teflon stretto
T1175A	211R	Piedino compensatore 1/16" destro teflon
T1176A	212R	Piedino compensatore 1/8" destro teflon
T1177A	213R	Piedino compensatore 3/16" destro teflon
T1178A	214R	Piedino compensatore 1/4" destro teflon
PER SUOLE RICAMBIO AGGIUNGERE AL NUMERO DEL PIEDINO LA LETTERA "S"		
M1173A		Piedino compensatore 1/32" destro per maglina
M1175A		Piedino compensatore 1/16" destro per maglina
M1176A		Piedino compensatore 1/8" destro per maglina
M1177A		Piedino compensatore 3/16" destro per maglina
M1178A		Piedino compensatore 1/4" destro per maglina

PIEDINI COMPENSATORI SINISTRI SUOLA TEFLON



T22L



T221L



T222L



T223L



T224L

N. di catalogo N. di descrizione	N. Originale	Descrizione
T22L		Piedino compensatore 1/32" sinistro teflon
T221L		Piedino compensatore 1/16" sinistro teflon
T222L		Piedino compensatore 1/8" sinistro teflon
T223L		Piedino compensatore 3/16" sinistro teflon
T224L		Piedino compensatore 1/4" sinistro teflon

PIEDINI COMPENSATORI MAGLINA ECONOMICI



EM1173A



EM1174A



EM1175A



EM1176A



EM1177A



EM1178A

N. di catalogo N. di descrizione	N. Originale	Descrizione
EM1173A		Piedino compensatore 1/32" destro
EM1174A		Piedino compensatore 1/32" destro stretto
EM1175A		Piedino compensatore 1/16" destro
EM1176A		Piedino compensatore 1/8" destro
EM1177A		Piedino compensatore 3/16" destro
EM1178A		Piedino compensatore 1/4" destro

PIEDINI COMPENSATORI PER BORDATORI

1192A



601



602



603



604



605



Zig-Zag

COMPENSATORI DESTRI PER ORLATORI



Stretto

1193A



Largo

1194A

N. di catalogo N. di descrizione	N. Originale	Descrizione
1192A	601	Piedino compensatore per bordatore fino 20 mm
1192A	602	Piedino compensatore per bordatore fino 25 mm
1192A	603	Piedino compensatore per bordatore fino 32 mm
1192A	604	Piedino compensatore per bordatore fino 36 mm
1192A	605	Piedino compensatore per bordatore fino 40 mm
1192A ZZ		Piedino compensatore per bordatore cucitura zig-zag
1193A		Piedino compensatore per orlatori stretto
1194A		Piedino compensatore per orlatori largo

PIEDINI COMPENSATORI PER TRASPORTO A PUNTA D'AGO



1210A

1210A	$\frac{1}{32}''=0,8$
1211A	$\frac{1}{16}''=1,6$
1212A	$\frac{1}{8}''=3,2$
1213A	$\frac{3}{16}''=4,8$
1214A	$\frac{1}{4}''=6,4$



1216A

1216A	$\frac{1}{32}''=0,8$
1217A	$\frac{1}{16}''=1,6$
1218A	$\frac{1}{8}''=3,2$
1219A	$\frac{3}{16}''=4,8$
1220A	$\frac{1}{4}''=6,4$



1221A

1221A	$\frac{1}{32}''=0,8$
1222A	$\frac{1}{16}''=1,6$
1223A	$\frac{1}{8}''=3,2$
1224A	$\frac{3}{16}''=4,8$
1225A	$\frac{1}{4}''=6,4$



1226A

1226A	$\frac{1}{32}''=0,8$
1227A	$\frac{1}{16}''=1,6$
1228A	$\frac{1}{8}''=3,2$
1229A	$\frac{3}{16}''=4,8$
1230A	$\frac{1}{4}''=6,4$



1231A

$\frac{1}{32}''$	0,8
$\frac{1}{16}''$	1,6
$\frac{1}{8}''$	3,2
$\frac{3}{16}''$	4,8
$\frac{1}{4}''$	6,4
$\frac{5}{16}''$	8



1231ASX

$\frac{1}{32}''$	0,8
$\frac{1}{16}''$	1,6
$\frac{1}{8}''$	3,2
$\frac{3}{16}''$	4,8
$\frac{1}{4}''$	6,4
$\frac{5}{16}''$	8

N. di catalogo N. di descrizione	N. Originale	Descrizione
1210A ÷ 1214A		Compensatore Necchi 831 destro da $\frac{1}{32}''$ a $\frac{1}{4}''$
1216A ÷ 1220A		Compensatore Necchi 831 sinistro da $\frac{1}{32}''$ a $\frac{1}{4}''$
1221A ÷ 1225A		Compensatore Necchi 881 destro da $\frac{1}{32}''$ a $\frac{1}{4}''$
1226A ÷ 1230A		Compensatore Necchi 881 sinistro da $\frac{1}{32}''$ a $\frac{1}{4}''$
1231A		Compensatore Pfaff 461-481 da $\frac{1}{32}''$ a $\frac{5}{16}''$ destro
1231A SX		Compensatore Pfaff 461-481 da $\frac{1}{32}''$ a $\frac{5}{16}''$ sinistro

PIEDINI COMPENSATORI - CON GUIDA 2 AGHI



1235A - 1237A

1235A	4,8	A filo
1236A	4,8	Distanziato
1237A	6,4	A filo
1238A	6,4	Distanziato



1236A - 1238A



1241A - 1243A

1240A	4,8	A filo
1241A	4,8	Distanziato
1242A	6,4	A filo
1243A	6,4	Distanziato



1240A - 1242A

N. di catalogo N. di descrizione	N. Originale	Descrizione
1235A - 1237A	A filo	Compensatore Necchi 921 con guida 2 aghi 4,8 - 6,4
1236A - 1238A	Distanziato	Compensatore Necchi 921 con guida 2 aghi 4,8 - 6,4
1240A - 1242A	A filo	Compensatore Necchi 971 con guida 2 aghi 4,8 - 6,4
1241A - 1243A	Distanziato	Compensatore Necchi 971 con guida 2 aghi 4,8 - 6,4

PIEDINI COMPENSATORI PER DOPPIE IMPUNTURE



1245A

1245A	$\frac{1}{32}$ "	$\frac{1}{4}$ "
	0,8 mm	6,4 mm
1246A	$\frac{1}{32}$ "	$\frac{5}{16}$ "
	0,8 mm	8 mm
1247A	$\frac{1}{32}$ "	$\frac{3}{8}$ "
	0,8 mm	9,5 mm
1248A	$\frac{1}{32}$ "	$\frac{1}{2}$ "
	0,8 mm	12,7 mm

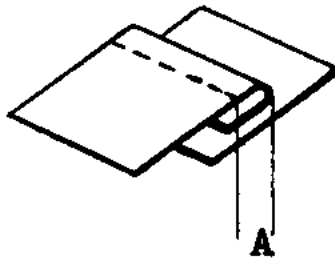

A

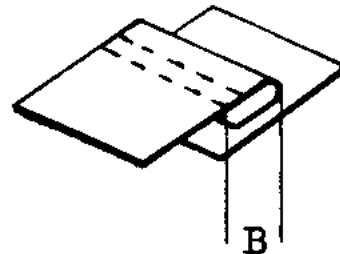

B



1250A

1250A	$\frac{1}{16}$ "	$\frac{1}{4}$ "
	1,6 mm	6,4 mm
1251A	$\frac{1}{16}$ "	$\frac{5}{16}$ "
	1,6 mm	8 mm
1252A	$\frac{1}{16}$ "	$\frac{3}{8}$ "
	1,6 mm	9,5 mm
1253A	$\frac{1}{16}$ "	$\frac{1}{2}$ "
	1,6 mm	12,7 mm

N. di catalogo N. di descrizione	N. Originale	Descrizione
1245A		Piedino compensatore doppie impunture 1 ago $\frac{1}{32}$ " x $\frac{1}{4}$ "
1246A		Piedino compensatore doppie impunture 1 ago $\frac{1}{32}$ " x $\frac{5}{16}$ "
1247A		Piedino compensatore doppie impunture 1 ago $\frac{1}{32}$ " x $\frac{3}{8}$ "
1248A		Piedino compensatore doppie impunture 1 ago $\frac{1}{32}$ " x $\frac{1}{2}$ "
1250A		Piedino compensatore doppie impunture 1 ago $\frac{1}{16}$ " x $\frac{1}{4}$ "
1251A		Piedino compensatore doppie impunture 1 ago $\frac{1}{16}$ " x $\frac{5}{16}$ "
1252A		Piedino compensatore doppie impunture 1 ago $\frac{1}{16}$ " x $\frac{3}{8}$ "
1253A		Piedino compensatore doppie impunture 1 ago $\frac{1}{16}$ " x $\frac{1}{2}$ "

PIEDINI COMPENSATORI PER DOPPIE IMPUNTURE ECONOMICI



E1245A



E1246A



E1250A



E1251A

N. di catalogo N. di descrizione	N. Originale	Descrizione
E1245A		Piedino compensatore doppie impunture 1 ago 1/32" x 1/4"
E1246A		Piedino compensatore doppie impunture 1 ago 1/32" x 5/16"
E1250A		Piedino compensatore doppie impunture 1 ago 1/16" x 1/4"
E1251A		Piedino compensatore doppie impunture 1 ago 1/16" x 5/16"

PIEDINI COMPENSATORI PER DURKOPP 212

1190A

Misure:
Destro



1/32"



1/16"



1/8"



3/16"



1/4"

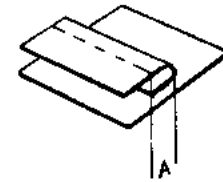

1191A

Misure:
Sinistro



1/32"



1/16"



1/8"



3/16"

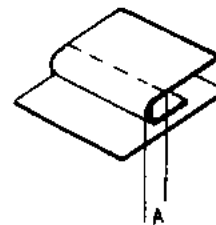

N. di catalogo N. di descrizione	N. Originale	Descrizione
1190A	710R	Piedino compensatore 1/32" destro
1190A	711R	Piedino compensatore 1/16" destro
1190A	712R	Piedino compensatore 1/8" destro
1190A	713R	Piedino compensatore 3/16" destro
1190A	714R	Piedino compensatore 1/4" destro
1191A	720L	Piedino compensatore 1/32" sinistro
1191A	721L	Piedino compensatore 1/16" sinistro
1191A	722L	Piedino compensatore 1/8" sinistro
1191A	723L	Piedino compensatore 3/16" sinistro

PIEDINI COMPENSATORI PER NECCHI A 2 AGHI CL 921 - 971



1201A



1202A



1203A



1204A



1205A



1206A

N. di catalogo N. di descrizione	N. Originale	Descrizione
1201A	destro	Piedino compensatore Necchi 921 2 aghi 4,8 - 6,4 mm
1202A		Piedino compensatore Necchi 921 bilaterale 4,8 - 6,4 mm
1203A		Piedino compensatore Necchi 921 doppia guida 4,8 - 6,4 mm
1204A	destro	Piedino compensatore Necchi 971 2 aghi 4,8 - 6,4 mm
1205A		Piedino compensatore Necchi 971 bilaterale 4,8 - 6,4 mm
1206A		Piedino compensatore Necchi 971 doppia guida 4,8 - 6,4 mm

Articoli vari

- Prezzatrici
- Etichettatrici
- Etichette autoadesive
- Articoli per sala taglio
- Bobinatori
- Apparecchiature ausiliare per il cucito
- Portaspole - filarelli - ginocchiere
- Guide per cuciture parallele
- Guide a rullo e guide ribaltabili
- Rasafili e accessori vari
- Pinze premi stoffa
- Pinze punzonatrici rotelle carrelli
- Cacciaviti e pinzette
- Cinghie trapezoidali artigianali - industriali
motori artigianali
- Cinghiette elastiche - trapezoidali - domestiche
motori domestici - reostati - carboncini
- Cinghia cuoio anelli gomma accessori vari
- Lame verticali per taglierine
- Lame tonde - taglierine a mano e nastri abrasivi
- Abrasivi e tela smeriglio
- Oliatori
- Oli e lubrificanti
- Forbici e cesoie
- Gessi in caolino e cera
- Spaziatori per bottoni ed asole
- Spilli
- Aghi sellaio
- rocchettini
- riflettore
- infila aghi - salvadito



MODELLI

Open
26x12
WAVY
RECT.

C6	C8	C10	C10
€269.80	€36728.90	€36.20 R70.80	R90.60 €13.81

Open
26x16
WAVY

S12	S14	S16	S16
€390.62 R763.99	€133.192 €800.50	\$660.200 €3293.06	€2686.04 €5200.900

Open
26x16
WAVY

C17	C17	C20	C20
£390.800 €201.83	€--600.200 €3606.07	299F1793.00 266€813.63	£-7723.33P €--9806.60

Open
32x19
WAVY
RECT.
37x19
RECT.

L77	L17	N24	X44
€1036.68 F6800.20	2682R7800.60 €3988.38	26-08-2000-8 F8024.60€198.92	02-2006S-980.60 02-2008€--71.26

Open
29x28
RECT.
37x28
RECT.

T177	T117	T011	W247-A1
30-06-2002- €3900.62 R7628.95	22-09 30-09 809F6800.20 €1036.68	Open 2488R600.000 3090€3606.07	26-APR--2009 06-2009F8024.60 € 198.92



MODELLI

22 x 12

2253

5 LETTERE FISSE E 3 NUMERI PROGRESSIVI

PROGRESSIONE SEMPLICE

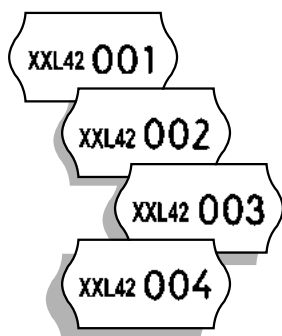

PROGRESSIONE DOPPIA

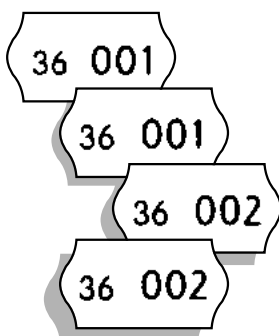

2234

5 LETTERE FISSE E 4 NUMERI PROGRESSIVI

PROGRESSIONE SEMPLICE

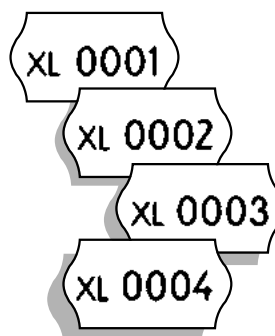

PROGRESSIONE DOPPIA

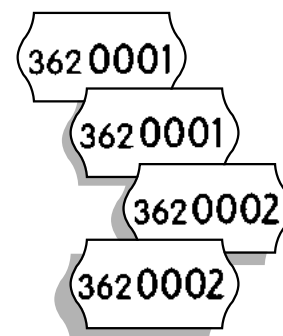

26 x 12

2653

5 LETTERE FISSE E 3 NUMERI PROGRESSIVI

PROGRESSIONE SEMPLICE

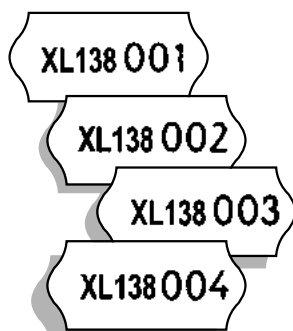

PROGRESSIONE DOPPIA

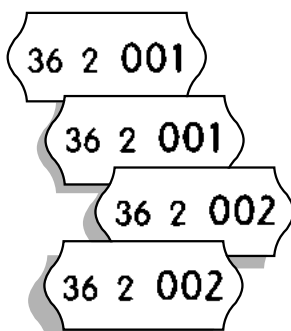

2644

5 LETTERE FISSE E 4 NUMERI PROGRESSIVI

PROGRESSIONE SEMPLICE

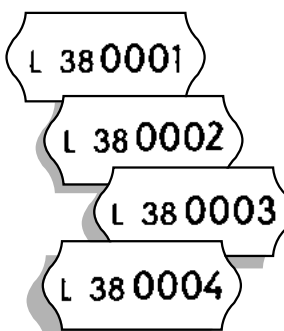

PROGRESSIONE DOPPIA

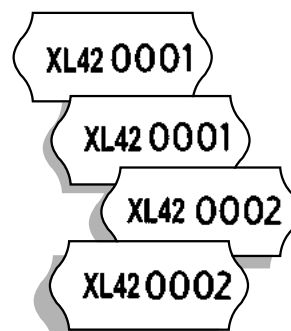

ETICHETTE AUTOADESIVE PER ETICHETTATRICI

BIANCO ROSSO ARANCIO
COLORATO COLORATO FLORO

22X12

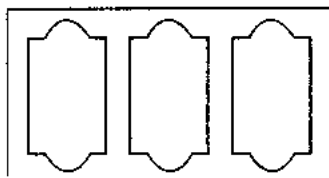

A) BIANCO
B) COLORATO: giallo - verde
rosa - azzurro - rosso
C) FLORO: arancio - verde
giallo - rosso - fucsia

BIANCO AZZURRO ROSSO
COLORATO COLORATO FLORO

26X12

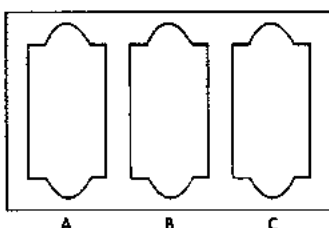

A) BIANCO
B) COLORATO: giallo - verde
rosa - azzurro - rosso
C) FLORO: arancio - verde
giallo - rosso - fucsia

BIANCO VERDE GIALLO
COLORATO COLORATO FLORO

26X16S

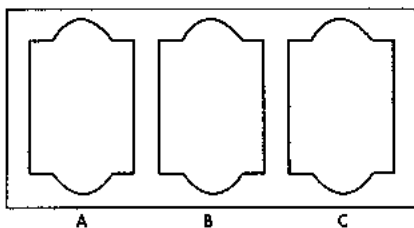

A) BIANCO
B) COLORATO: giallo - verde
rosa - azzurro - rosso
C) FLORO: arancio
verde
giallo
rosso
fucsia

BIANCO ROSA VERDE BIANCA
COLORATO COLORATO FLORO STAMPATA

26X16R

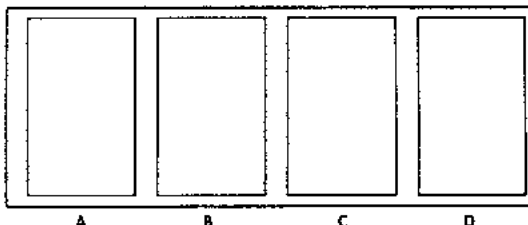

A) BIANCO
B) COLORATO: giallo
verde
rosa - azzurro
rosso
C) FLORO: arancio
giallo
verde - rosso
fucsia
D) STAMPATO

BIANCO GIALLO FUCSIA
COLORATO COLORATO FLORO

32X19

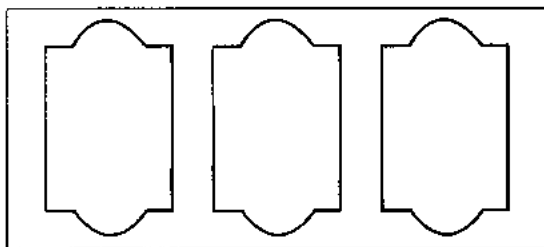

A) BIANCO
B) COLORATO: giallo
verde
rosa - azzurro
rosso
C) FLORO: arancio
giallo
verde - rosso
fucsia

TAMPONI PER INCHIOSTRATORI



L'inchiostro è solo nel colore nero.
Disponiamo di un tampone con inchiostro speciale per paesi molto caldi.

RETROSTAMPE CON RELATIVI TIPI DI COLLANTI

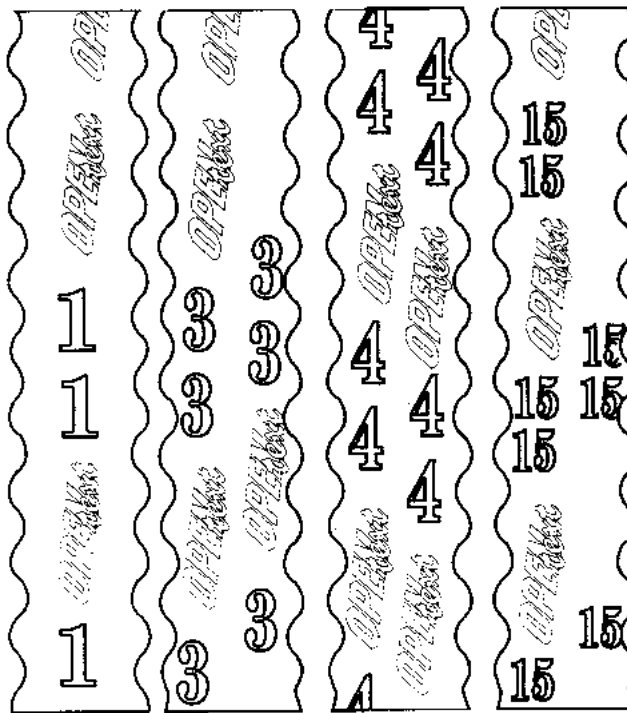

SPECIFICHE RELATIVE AI DIVERSI TIPI DI COLLA PER LE ETICHETTE AUTOADESIVE

- 1) La retrostampa OPENTEX 1 indica che il collante utilizzato è del tipo leggero e viene denominato: removibile. Questa caratteristica rende estremamente facile la rimozione dell'etichetta senza lasciare residui di colla sul tessuto. Questo tipo di collante è conforme alle normative FDA (Usa) e BGA (Germania).
Temperatura di esercizio compresa tra: 0° ÷ +80° C
- 3) La retrostampa OPENTEX 3 indica che il collante utilizzato è del tipo medio denominato: permanente. Garantisce un'ottima coesione e può essere utilizzato in quasi tutte le applicazioni nel settore della confezione. Questo tipo di collante è conforme alle normative FDA (Usa) e BGA (Germania).
Temperatura di esercizio compresa tra: 0° ÷ +100° C
- 4) La retrostampa OPENTEX 4 indica che il collante utilizzato è del tipo forte denominato appunto: forte. Il forte potere di coesione rende difficile la rimozione dell'etichetta e deve essere impiegato ove non sia possibile l'utilizzo degli altri tipi (A, B, D). Da ciò si evince che è consigliabile per tessuti come jeans, cotone e tessuti pesanti in genere.
Temperatura di esercizio compresa tra: 0° ÷ +100° C
- 15) La retrostampa OPENTEX 15 indica che il collante utilizzato pur avendo un notevole potere di coesione non lascia alcun residuo sui tessuti e per questo è denominato: antimacchia. Detto collante mantiene inalterate le sue caratteristiche anche se sottoposto a temperature elevate, quindi particolarmente indicato nella stiratura a caldo. Ne è consigliato l'uso su tessuti molto delicati come la seta, il lino e gli altri similari.
Temperatura di esercizio compresa tra: -10° ÷ +120° C

ARTICOLI PER SALA TAGLIO

E1470P



E1472A

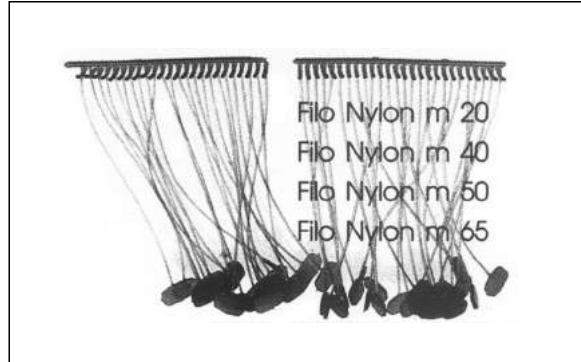

YH120



YH170



YH20B



YH935



N. di catalogo N. di descrizione	N. Originale	Descrizione
E1470AP		Pistola economica per attaccare i cartellini
YH120		Pistola nebulizzatrice per liquido smacchiatore
YH170		Pistola nebulizzatrice per liquido smacchiatore
YH20B		Spruzzatore regolabile per pistola
YH935		Mini taglierina elettrica
E1472A		Punti polipropilene mm 20 - 25 - 35 - 50 - 65

ARTICOLI PER SALA TAGLIO

1470A



1471A/F

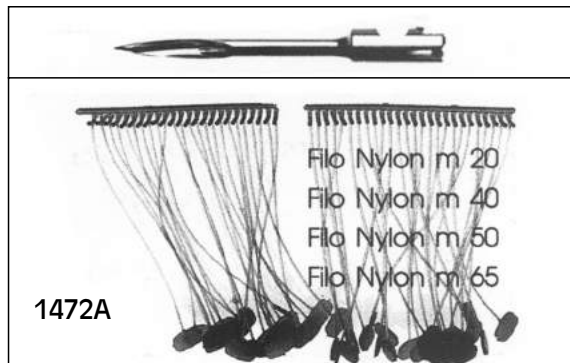

1475A

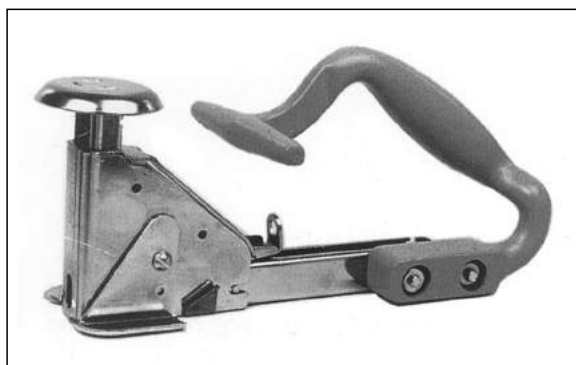

1476A

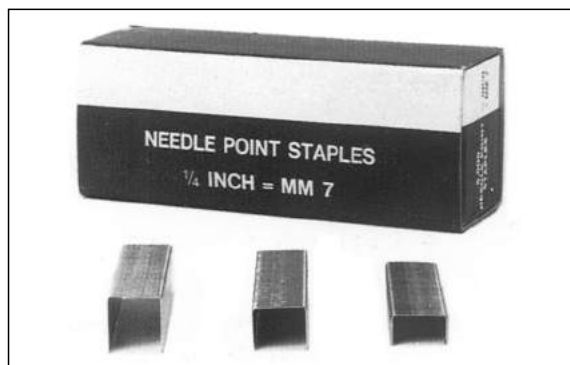

1500A

1500AL

N. di catalogo N. di descrizione	N. Originale	Descrizione
1470A		Pistola per attaccare i cartellini
1471A		Ago di ricambio per detta
1471AF		Ago di ricambio fine
1472A		Filo nylon mm 15, 20, 25, 40, 50, 65
1475A	L19	Graffettatrice "BATES"
1476A	1/4 - 3/8 - 1/2	Punti per graffettatrice "BATES" mm 7, 10, 13
1500A		Taglierina modello AS 100
1500AL		Lama di ricambio per taglierina

ARTICOLI PER SALA TAGLIO

Volta
cinture

1302A

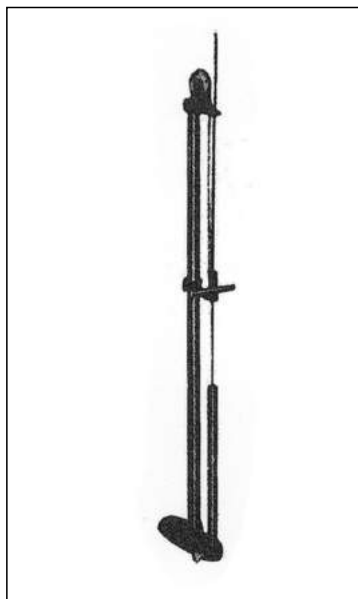

Volta
colli
a pedale

1303A

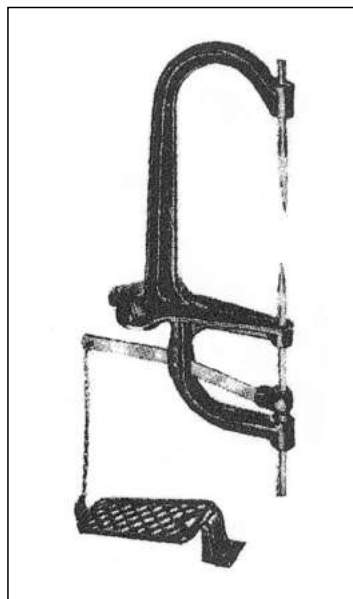

Rocchetto avvolgi fettucce
con piedistallo

1304A



Porta
nastri

1308A

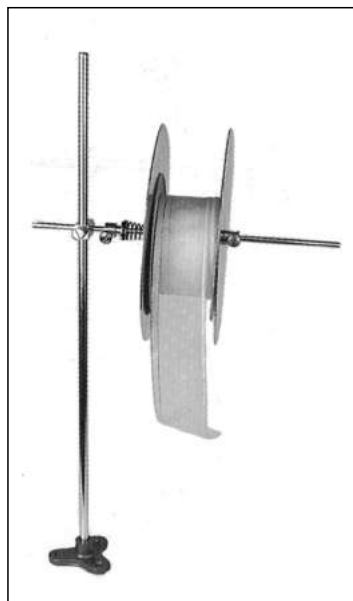

N. di catalogo N. di descrizione	N. Originale	Descrizione
1302A		Apparecchio volta-cinture
1303A		Apparecchio volta-colli
1304A		Rocchetto avvolgi fettucce
1308A		Sostegno raccoglitore di nastri

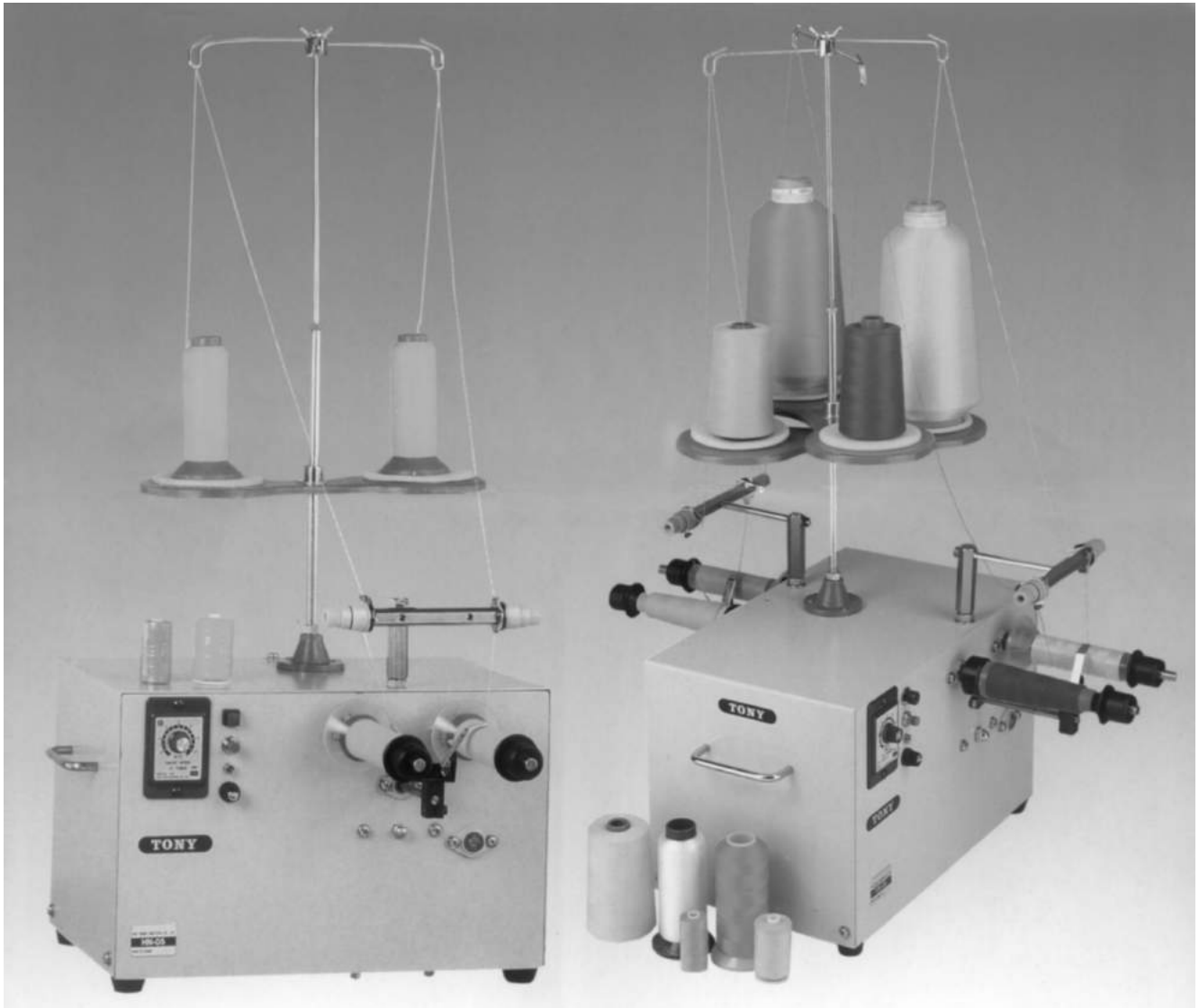

H-02
Bobinatore a 2 coni

H-04
Bobinatore a 4 coni

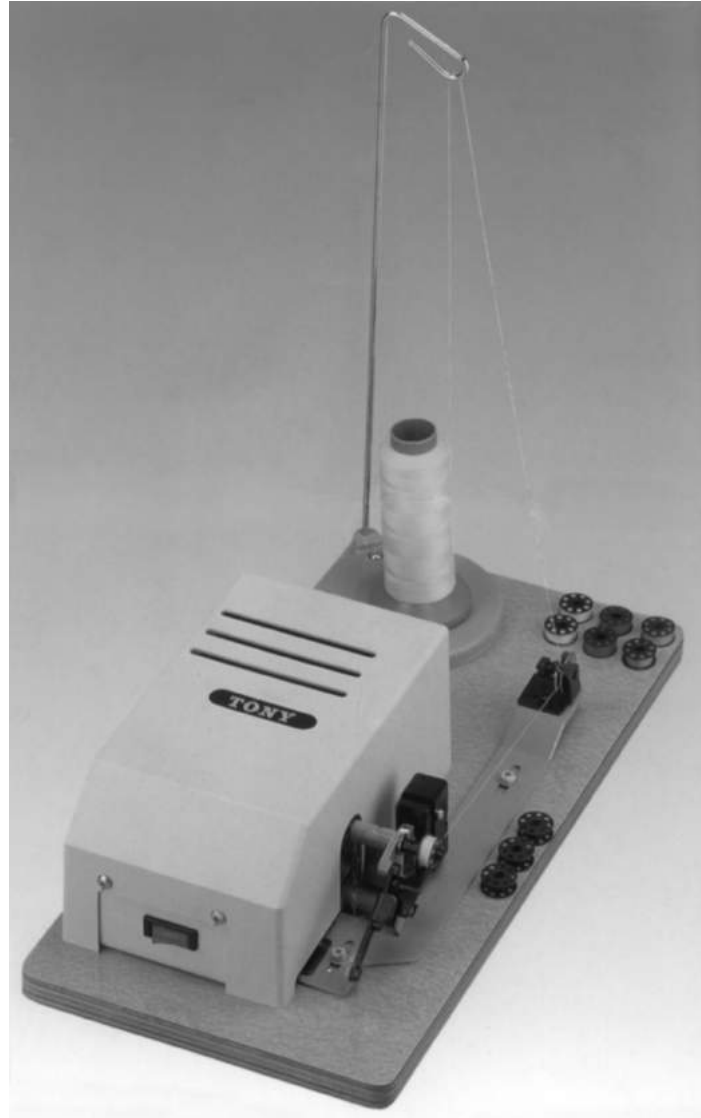

H-1-L
Bobinatore per rocchetti

APPARECCHIATURE AUSILIARI PER IL CUCITO

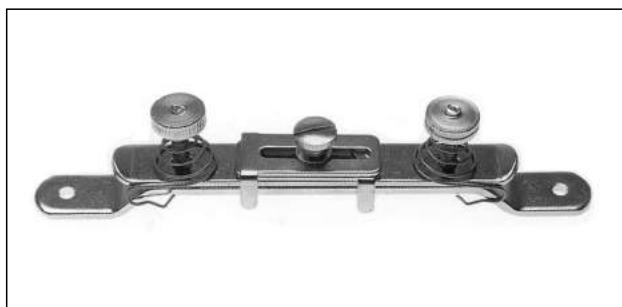

1305A



1377A



LAV



1306A

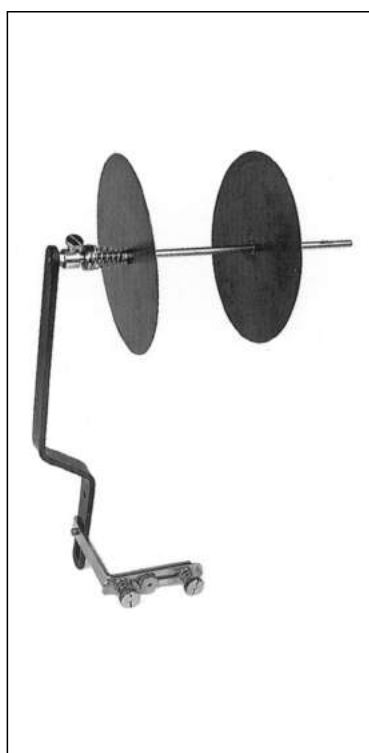

1307A



1375A

N. di catalogo N. di descrizione	N. Originale	Descrizione
1305A	S286	Apparecchio regolabile guida fettucce
1306A	TRWW2	Apparecchio porta-nastro Singer W.W.
1307A	TR95	Apparecchio porta-nastro per Singer tipo 31 / 96 / 241
1375A	A/80	Riflettore industriale
1377A		Lampadina per macchine domestiche 220 Volt
LAV		Lampadina a vite per macchine domestiche

PORTASPOLE - FILARELLI - GINOCCHIERE



B1332A

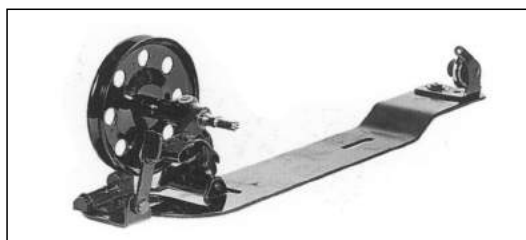

1327A

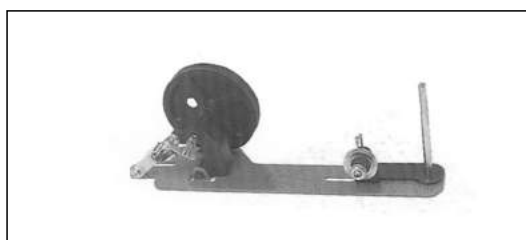

1328A



1329A

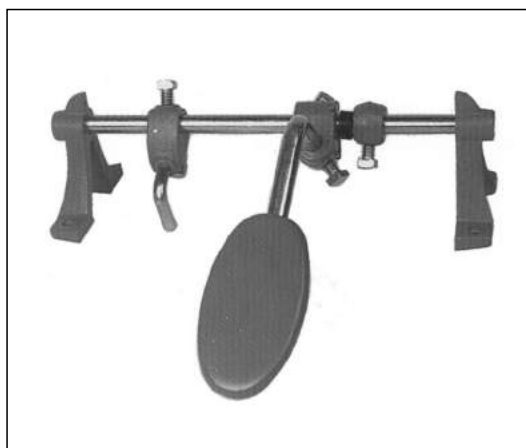

1331A

N. di catalogo N. di descrizione	N. Originale	Descrizione
B1332A		Portaspole a bandiera a 3 o 6 fili
1327A	259431	Filarello da banco tipo Singer
1328A		Filarello da banco tipo normale
1329A	31441	Ginocchiera tipo Pfaff
1331A	84789	Ginocchiera tipo Singer KI 31

GUIDE PER CUCITURE PARALLELE



C1310A



P1310A



1311A



1312A



1313A



1314A



1316A



1318A



1398A

N. di catalogo N. di descrizione	N. Originale	Descrizione
C1310A		Guida a scatto per camiceria
P1310A		Guida a scatto per pelletteria
1311A	MG1	Guida calamitata tipo lungo
1312A	SMG	Guida calamitata tipo corto
1313A	25873	Guida tripla
1314A	120428	Guida regolabile
1316A	25878	Guida a "T"
1318A	25990	Guida a trapunto ø mm 9
G1318A		Guida a trapunto ø mm 14
1318A11		Guida a trapunto ø mm 11
1398A	940012	Guida a trapunto tipo Necchi

GUIDE A RULLO E GUIDE RIBALTABILI

P1317A



1317A



1311AG



1323A



1324A



1325A



1326A

N. di catalogo N. di descrizione	N. Originale	Descrizione
1317A	RG1	Guida con rullo snodato
P1317A	25829	Guida con rullo fisso
1323A		Guida ribaltabile nuovo modello
1324A	53617	Guida ribaltabile micrometrica
1325A		Ricambio per cucitura diritta
1326A		Blocchetto porta bordatore
1311AG		Guida calamitata grande

RASAFILI E ACCESSORI VARI



1319A



1320A



R1320A

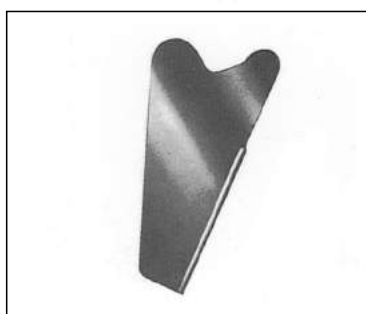

1321A



R1321A



1309A



1404A

1330A

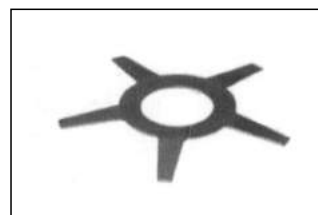

1403A

1405A



N. di catalogo N. di descrizione	N. Originale	Descrizione
1319A		Rasafilo in plastica
1320A		Rasafilo a molla esterna
R1320A		Rasafilo a molla interna
1321A		Rasafilo per placca
R1321A		Rasafilo ad anello
1309A		Bottone ferma piedino
1330A		Molla a stella
1403A		Taglia asole
1404A		Taglia asole grande
1405A		Infila aghi

PINZE PREMISTOFFA



1355A



1356A

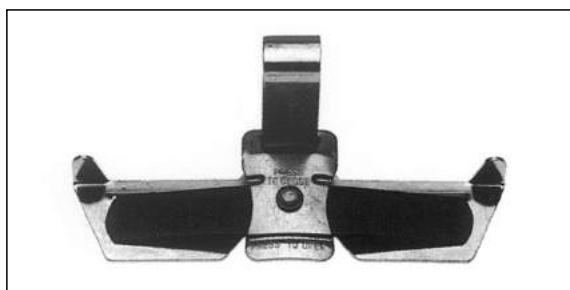

1357A

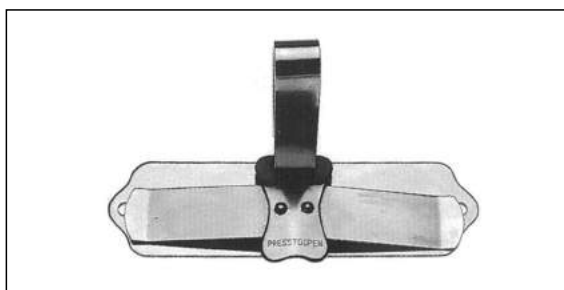

1358A



1359



1360A

N. di catalogo N. di descrizione	N. Originale	Descrizione
1355A		Pinza premistoffa regolabile mod. piccolo
1356A		Pinza premistoffa regolabile mod. grande
1357A		Pinzetta premistoffa regolabile mod. piccolo
1358A		Pinza premistoffa regolabile mod. grande
1359A		Pinza premistoffa a mano mod. piccolo
1360A		Pinza premistoffa a mano mod. grande

PINZE - PUNZONATRICI - ROTELLE - CARRELLI

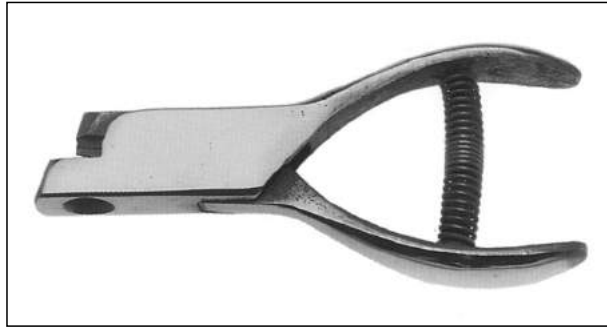

1349A



1/16x5/16

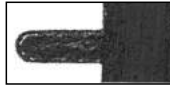

1/8x5/16



1/16x1/4



1/8x1/4

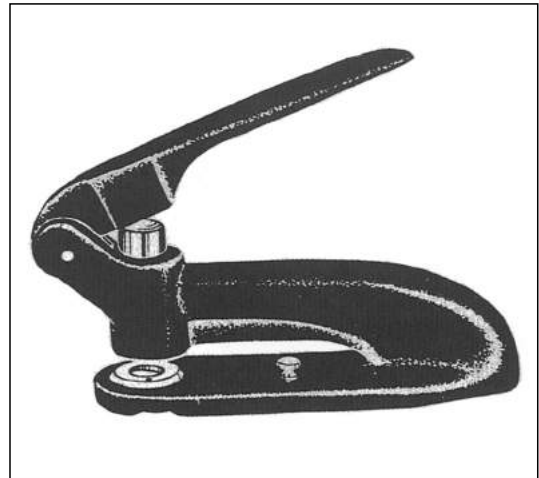

1350A



1340A

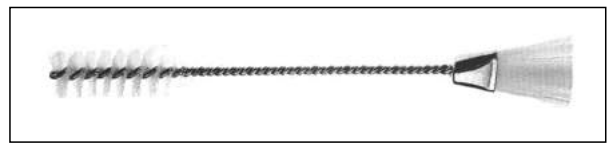

1339A

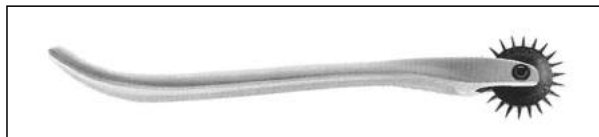

1341A

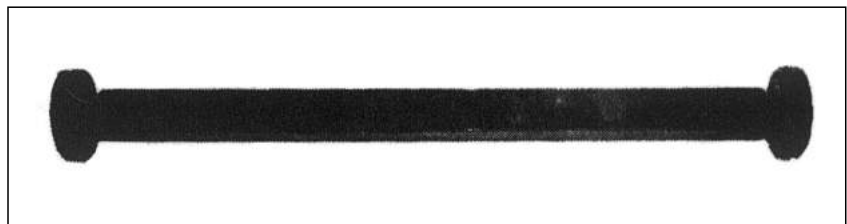

1378A

N. di catalogo N. di descrizione	N. Originale	Descrizione
1349A	50 N1/16	Pinza per tacche 1/16x5/16
1349A	45 N1/16	Pinza per tacche 1/16x1/4
1349A	50 L1/8	Pinza per tacche 1/8x5/16
1349A	45 L1/8	Pinza per tacche 1/8x1/4
1350A	PU 10	Punzonatrice per modelli
1339A		Spazzolino in nylon
1340A		Rotella copiatrice tipo normale
1341A		Rotella copiatrice tipo a punta d'ago
1378A		Carrello per trasporto bancali

CACCIAVITI E PINZETTE

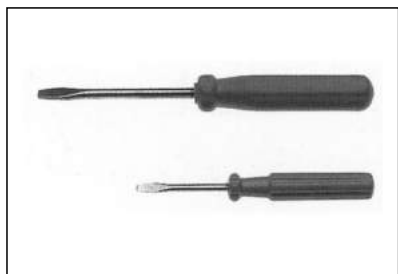

1365A 1366A

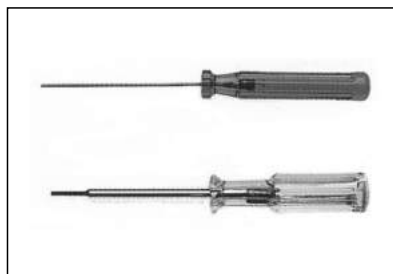

1370A 1371A

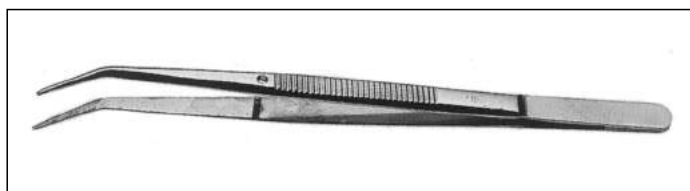

1363A



1361A



1362A

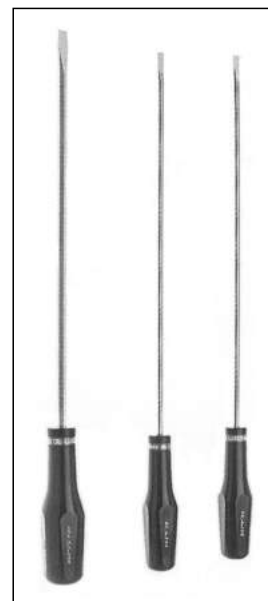

1367A = 3,5x250
1368A = 4,0x250
1369A = 5,5x250

N. di catalogo N. di descrizione	N. Originale	Descrizione
1365A		Cacciaviti piccoli
1366A		Cacciaviti medi
1367 / 1368 / 1369A		Cacciaviti lunghi
1370A	99074	Cacciaviti a brugola tipo rimoldi
1371A	37919	Cacciaviti a brugola tipo W. & G.
1363A		Pinzetta tipo curvo extra
1362A		Pinzetta tipo dritto
1361A		Pinzetta tipo curvo

CINGHIE TRAPEZOIDALI ARTIGIANALI - INDUSTRIALI

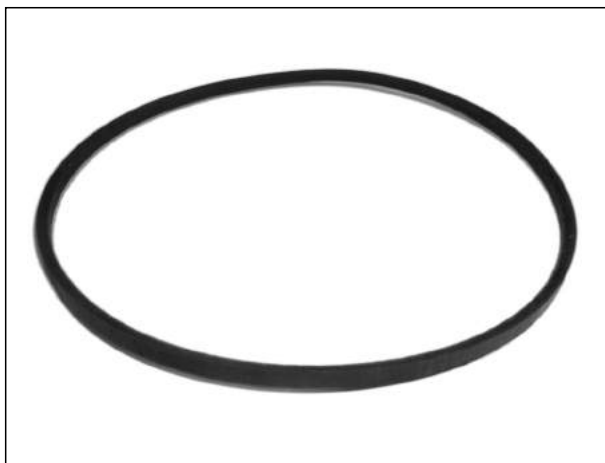

CODICE	DIMENSIONI
CT 670	8 x 5 x 670
CT 710	8 x 5 x 710
CT 750	8 x 5 x 750
CT 800	8 x 5 x 800
CT 830	8 x 5 x 830
CT 850	8 x 5 x 850
CT 900	8 x 5 x 900
CT 950	8 x 5 x 950
CT 1000	8 x 5 x 1000



CODICE	DIMENSIONI	
ICM 60	10 x 840	Z 32
ICM 61	10 x 887	Z 34
ICM 62	10 x 947	Z 36-1/2
ICM 63	10 x 1000	Z 38-1/4
ICM 64	10 x 1022	Z 39-3/8
ICM 65	10 x 1040	Z 40
ICM 66	10 x 1055	Z 40-1/2
ICM 67	10 x 1087	Z 42
ICM 68	10 x 1122	Z 43
ICM 69	10 x 1145	Z 45
ICM 70	10 x 1165	Z 45-1/2

MOTORI ARTIGIANALI



CODICE	POTENZA	GIRI
IRM 1/3 V	250 W	6000
IRM 1/5 V	150 W	4000

CINGHIETTE ELASTICHE - TRAPEZOIDALI - DOMESTICHE - CARBONCINI

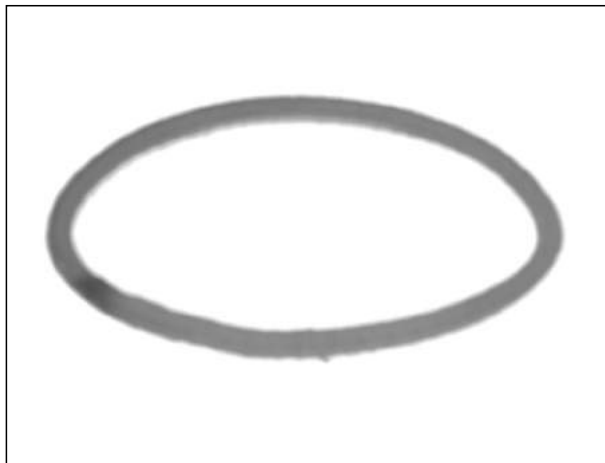

CODICE

CE 270
CE 290
CE 314
CE 330
CE 350
CE 370
CE 470
CE 950
CE 1020

CARBONCINI

CODICE

4x3	5x8T con treccia
4x4	5x10T con treccia
4x4T con treccia	6x6T con treccia
4x5	6x7T con treccia
4x5S scanalato	6x8
4x5T con treccia	6x9
5x5	6x9T con treccia
5x6	CTRI
5x8	tondo x reostato



CODICE

DIMENSIONI

CT 300	6 x 300
CT 315	6 x 315
CT 330 A	6 x 330
CT 330 B	5 x 330
CT 335	5 x 335 NECCHI
CT 500 A	6 X 500 BORLETTI
CT 500 B	5 X 500 VIGORELLI

MOTORI DOMESTICI



CODICE	POTENZA	GIRI
DRM 1/10	75 W	7000
DRM 1/12	60 W	6000
DRM 1/15	50 W	5000
MIN	50 W	5000
MIB	40 W	4000



DRM 8
Reostato



DRM 11
Spina

CINGHIA CUOIO ANELLI GOMMA E ACCESSORI VARI



1420A

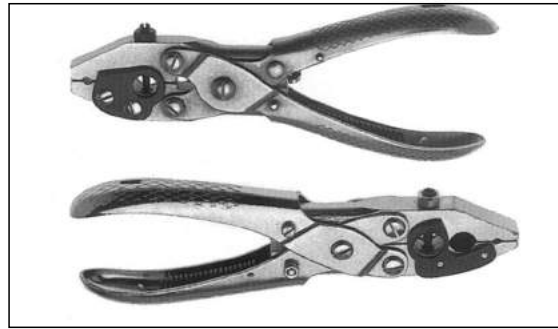

1347A = TIPO PICCOLO

1348A = TIPO GRANDE

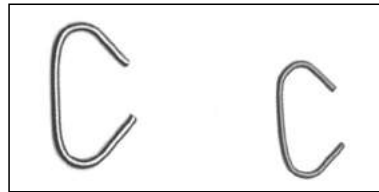

1421A



1425A



1440A

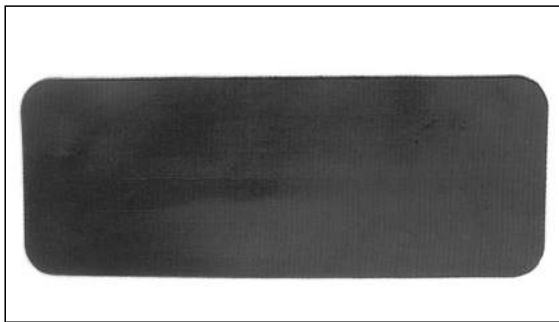

1430A

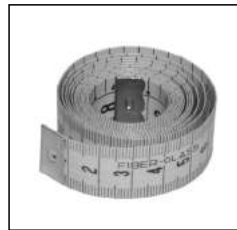

CFG

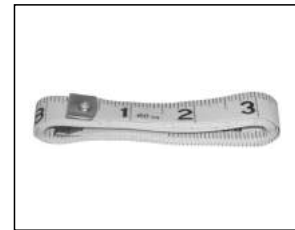

CFGP

N. di catalogo N. di descrizione	N. Originale	Descrizione
1420A		Cinghia cuoio ø 5 - 6 - 7 - 8 - 9 - 10
1421A		Ganci cinghia n° 4 - 5 - 6 - 7 - 8 - 9
1347A	547	Tenaglia per cinghia piccola
1348A	548	Tenaglia per cinghia grande
1425A		Anelli gomma n° 3 - 4 - 5 - 6 - 7 - 8 - 9
1430A		Placca magnetica ferma rocchettini
1440A		Conta pezzi
CFG		Centimetro fiber-glass 1,5 mt
CFGP		Centimetro + Pollici 60"

LAME VERTICALI PER TAGLIERINE

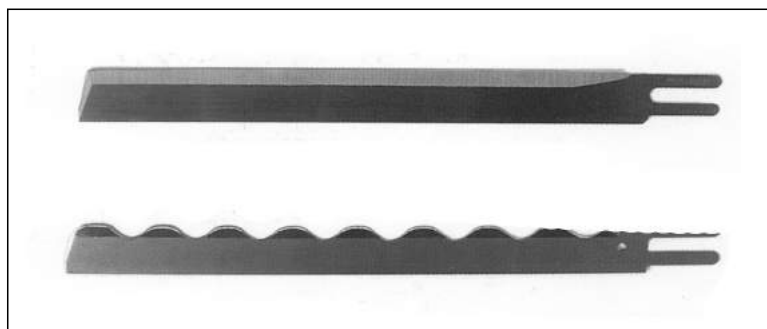

EASTMAN	HSS liscia	ondulata
4 ^a	1333AE 4	
5 ^a	1333AE 5	
6 ^a	1333AE 6	1333AEO 6
7 ^a	1333AF 7	
8 ^a	1333AE 8	1333AEO 8
9 ^a	1333AE 9	
10 ^a	1333AE 10	1333AEO 10

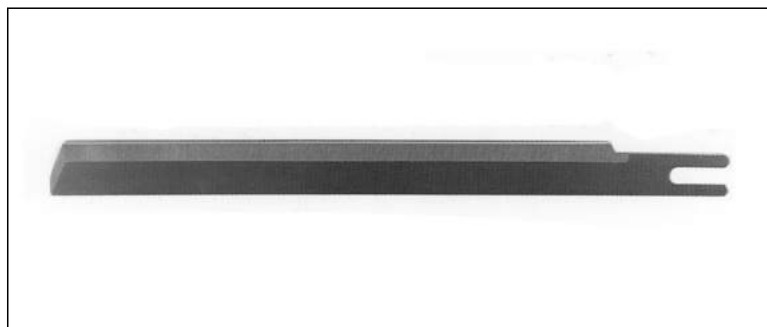

WOLF	HSS liscia
4 ^a	1333AW 4
5 ^a	1333AW 5
6 ^a	1333AW 6
7 ^a	1333AW 7
8 ^a	1333AW 8
9 ^a	1333AW 9
10 ^a	1333AW 10

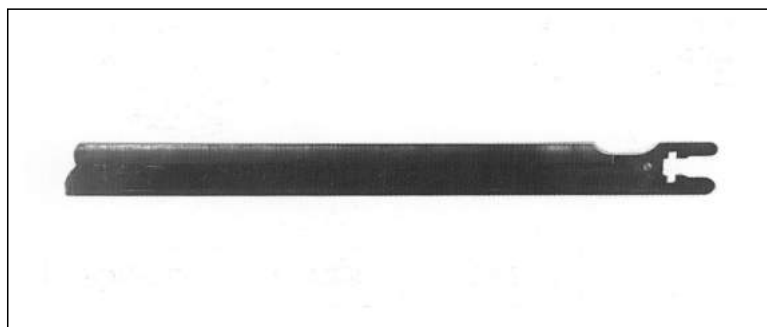

MAIMIN	HSS liscia
4 ^a	1333AM 4
5 ^a	1333AM 5
6 ^a	1333AM 6
7 ^a	1333AM 7
8 ^a	1333AM 8
9 ^a	1333AM 9
10 ^a	1333AM 10

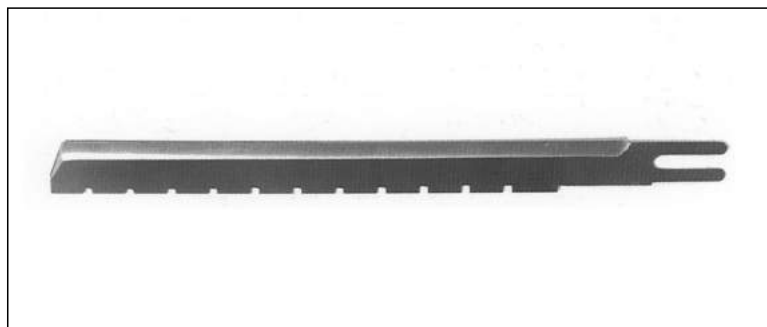

KURIS	HSS liscia
4 ^a	1333AK 4
5 ^a	1333AK 5
6 ^a	1333AK 6
7 ^a	1333AK 7
8 ^a	1333AK 8
9 ^a	1333AK 9
10 ^a	1333AK 10

N. di catalogo N. di descrizione	N. Originale	Descrizione
1333AE		Lame verticali tipo EASTMAN normali
133AEO		Lame verticali tipo EASTMAN ondulate
1333AW		Lame verticali tipo WOLF normali
1333AM		Lame verticali tipo MAIMIN normali
1333AK		Lame verticali tipo KURIS normali

LAME TONDE TAGLIERINE A MANO E NASTRI ABRASIVI



1435A



1436



1437A



1438A

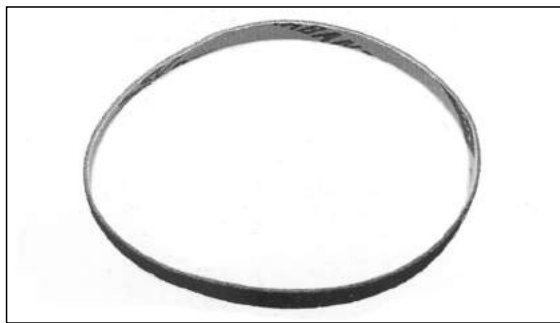

1335A

TIPO	GRANA	CODICE
Eastman	fine	1335A EGF
Eastman	media	1335A EGM
Eastman	grossa	1335A EGG
Maimin	fine	1335A MGF
Maimin	media	1335A MGM
Maimin	grossa	1335A MGG
KM 5	media	1335A KMGM

N. di catalogo N. di descrizione	N. Originale	Descrizione
1435A	ST800	Taglierina a mano Eastman piccola
1436A	C280	Lama di ricambio per detta
1437A	ST800	Taglierina a mano Eastman grande
1438A	C450	Lama di ricambio per detta
1335A		Nastri abrasivi per taglierine

ABRASIVI E TELA SMERIGLIO

codice	larghezza	lunghezza	grana
1336A 4	mm 4	25 mt.	220
1336A 6	mm 6	25 mt.	220
1336A 8	mm 8	25 mt.	220

1336A

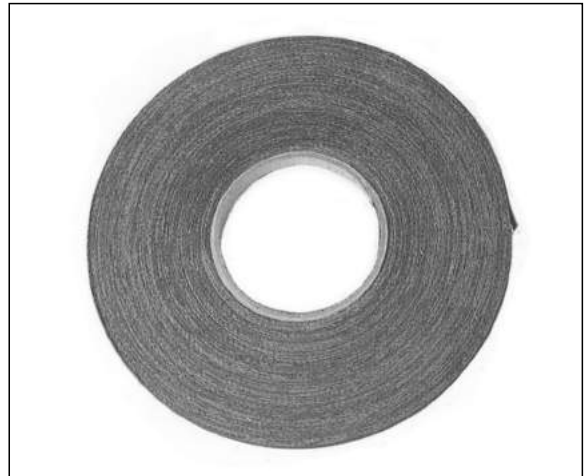

Sezione
circolare

codice	diametro o larghezza	mod.	grana
1337A 48	2.36	48	150
1337A 49	2.08	49	120
1337A 50	1.76	50	180
1337A 51	1.40	51	120
1337A 52	1.40	52	150
1337A 53	1.02	53	180
1337A 54	0.76	54	200
1337A 54H	0.76	54H	200
1337A 55	0.46	55	200
1337A 60	0.38	60	200

1337A

Sezione
Rettangolare

1337A 01	1.59	01	130
1337A 56	2.38	56	180
1337A 57	3.18	57	180
1337A 58	4.76	58	150
1337A 59	6.35	59	150

codice	tipo	grana
1338A 100	smeriglio	100
1338A 120	smeriglio	120
1338A 150	smeriglio	150
1338A 180	smeriglio	180
1338A 220	smeriglio	220
1338A 240	smeriglio	240
1338A 280	smeriglio	280
1338A 320	smeriglio	320
1338A SP	spuntiglio	800

1338A



N. di catalogo N. di descrizione	N. Originale	Descrizione
1336A		Tele smeriglio in rotoli
1337A		Filo abrasivo in rocchetti
1338A		Tela smeriglio in fogli

OLIATORI



1400A



1342A



1343A



1344A



1345A



1346A

N. di catalogo N. di descrizione	N. Originale	Descrizione
1400A		Oliatore famiglia
1342A		Oliatore ind. tipo piccolo
1343A		Oliatore ind. tipo grande
1344A		Oliatore ind. tipo piatto
1345A		Oliatore a pressione mod. piccolo
1346A		Oliatore a pressione mod. grande

OLIO VASELINA E OLIO DENSO



1390A



1391A



1392A

1393A



1394A1L

1394A5L



1396A

1395A

N. di catalogo N. di descrizione	N. Originale	Descrizione
1390A		Flacone olio g. 125 con beccuccio
1391A		Flacone olio vaselina g. 500
1392A		Flacone olio vaselina l. 1
1393A		Flacone olio vaselina l. 5
1395A		Flacone olio denso l. 1
1396A		Flacone olio denso l. 5
1394A1L		Flacone olio antimacchia white 32 l. 1
1394A5L		Flacone olio antimacchia white 32 l. 5

ADESIVI - SMACCHIATORI - PULITORI - IMPERMEABILIZZANTI



1414A

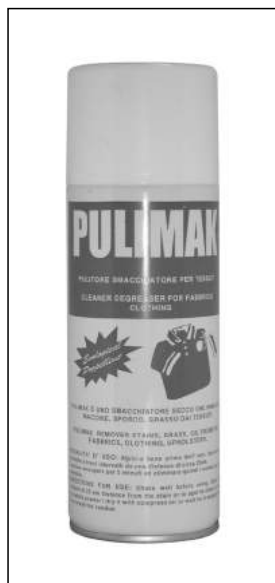

1416A



1417A



1418A



1419A



1422A



1423A

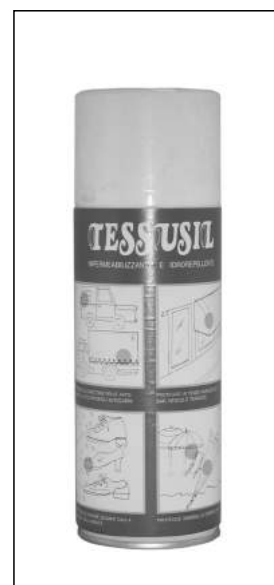

1424A

N. di catalogo N. di descrizione	N. Originale	Descrizione
1414A		Bomboletta adesivo temporaneo
1416A		Bomboletta smacchiatore per tessuti
1417A		Tanica smacchiatore kg 10
1418A		Bomboletta adesivo permanente 600 ml
1419A		Adesivo permanente per ricamificio 500 ml
1422A		Solvente puntore spray 500 ml
1423A		Pulitore sgrassante 400 ml
1424A		Impermeabilizzante per pelli 400 ml

LUBRIFICANTI IN EMULSIONE E SPRAY



1351A



1352A



1354A



1410A



1411A



1412A



1413A

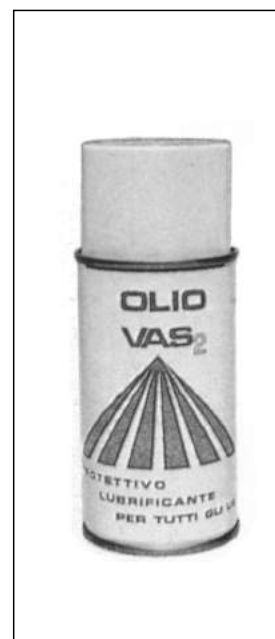

1397A

N. di catalogo N. di descrizione	N. Originale	Descrizione
1351A		Emulsione di silicone gr. 500 - 1 litro - 5 litri
1352A		Bomboletta silicone spray
1354A		Vaschetta silicone con serbatoio
1410A		Lubrosol gr. 500 - 1 litro - 5 litri
1411A		Bomboletta teflon spray
1412A		Bomboletta aria compressa
1413A		Bombola "sblok"
1397A		Bomboletta - olio spray vas. 2

FORBICI E CESCOIE DI PRODUZIONE NAZIONALE



1462A
6" 7" 8"

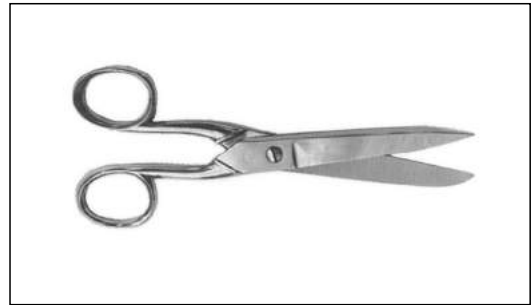

1463A
4" 5" 6" 7"



1464A
7" 8" 9"
10" 11" 12"



1465A 3-1/2" 4-1/2"

1466A 3-1/2" 4-1/2"



1467A
6" 7" 8"-1/2"



1470A
4-1/2" 5-1/2"
7" 8-1/2"



1468A

1469A

N. di catalogo N. di descrizione	N. Originale	Descrizione
1462A	6" 7" 8"	Forbice da sartina
1463A	4" 5" 6" 7"	Forbice da lavoro
1464A	7" 8" 9" 10" 11" 12"	Cesoia per sarto
1465A	3-1/2" 4-1/2"	Forbicina da ricamo curva
1466A	3-1/2" 4-1/2"	Forbicina da ricamo dritta
1467A	6" 7" 8-1/2"	Forbice tagliacampioni
1468A		Forbice per tessitore punta curva
1469A		Forbice per tessitore punta dritta
1470A	4-1/2" 5-1/2" 7" 8-1/2"	Forbice con manico in plastica

FORBICI E CESCOIE KAI



KAI 5090 9"



KAI SL10 10"



KAI 526



KAI BB09 9"



KAI BB10 10"



KAI BB11 11"



KAI BB12 12"



KAI SB09 9"



KAI SB10 10"



KAI SB11 11"

N. di catalogo N. di descrizione	Misure	Descrizione
KAI 5090	9"	Forbici "slim-light"
KAI SL10	10"	Forbici "slim-light"
KAI 526		Forbici per sarto con vite di regolazione
KAI BB09	9"	Cesoia sarto forgiata
KAI BB10	10"	Cesoia sarto forgiata
KAI BB11	11"	Cesoia sarto forgiata
KAI BB12	12"	Cesoia sarto forgiata
KAI SB09	9"	Cesoia sarto lubrificabile
KAI SB10	10"	Cesoia sarto lubrificabile
KAI SB11	11"	Cesoia sarto lubrificabile

FORBICI E CESCOIE KAI



KAI 5100
KAI 5100C curve



KAI 5120
KAI 5123 lame di ricambio



KAI 5135



KAI 5165
KAI 5165MD microdentate
KAI 5165C curve

N. di catalogo N. di descrizione	Misure	Descrizione
KAI 5100	4"	Forbicine ricamo
KAI 5100C	4"	Forbicine ricamo curve
KAI 5120	4-1/2"	Forbicine rasafilo
KAI 5123		Lame di ricambio
KAI 5135	5-1/2"	Forbici per ricamo
KAI 5165	6-1/2"	Forbici macchinista
KAI 5165MD	6-1/2"	Forbici macchinista microdentate
KAI 5165C	6-1/2"	Forbici macchinista curve

FORBICI E CESCOIE KAI



KAI 5210
 KAI 5210MD microdentata
 KAI 5210KE
 KAI 5210L sinistra
 KAI 5220 curva



KAI 5230
 KAI 5230KE



KAI 5250

N. di catalogo N. di descrizione	Misure	Descrizione
KAI 5210	8"-1/2"	Cesoia per sarta
KAI 5210MD	8"-1/2"	Cesoia per sarta microdentata
KAI 5210KE	8"-1/2"	Cesoia per sarta
KAI 5210L	8"-1/2"	Cesoia per sarta sinistra
KAI 5220	8"-1/2"	Cesoia per sarta curva
KAI 5230	9"	Cesoia per sarta
KAI 5230KE	9"	Cesoia per sarta
KAI 5250	10"	Cesoia per sarta

FORBICI E CESCOIE KAI



KAI 5275



KAI 5350

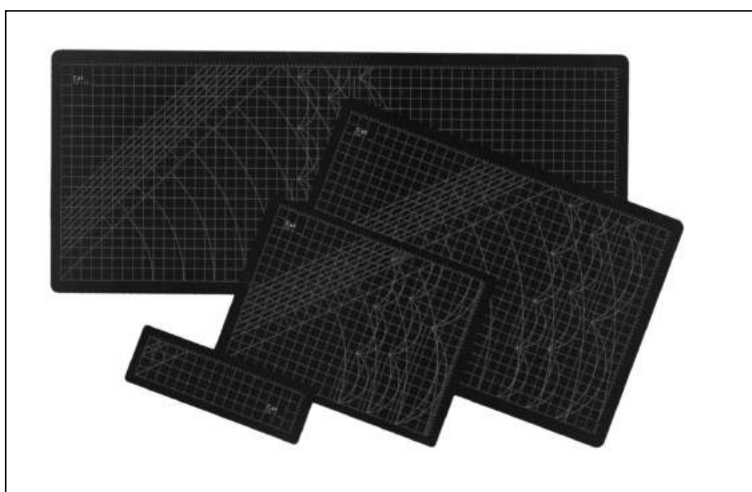

- KAI CB 143 600mm x 1430mm
- KAI CB 1 600mm x 900mm
- KAI CB 2 450mm x 600mm
- KAI CB 3 150mm x 460mm

N. di catalogo N. di descrizione	Misure	Descrizione
KAI 5275	11"	Cesoie per tessuti spessi
KAI 5350	8"	Forbici tagliacampioni
KAI CB143	60 x 143	Tavola per taglio
KAI CB1	60 x 90	Tavola per taglio
KAI CB2	45 x 60	Tavola per taglio
KAI CB3	15 x 46	Tavola per taglio

FORBICI E CESCOIE



2055 5,5"
2055MD microdentata



2065 6,5"
2065MD microdentata



2085 8,5"
2085MD microdentata



272 9" 10" 12"



303-8 8"



308-8 8"



FTS



YH 601

N. di catalogo N. di descrizione	Misure	Descrizione
2055	5,5"	Forbici acciaio inox temperato
2065	6,5"	Forbici acciaio inox temperato
2085	8,5"	Forbici acciaio inox temperato
2055MD	5,5"	Forbici acciaio inox temperato microdentate
2065MD	6,5"	Forbici acciaio inox temperato microdentate
2085MD	8,5"	Forbici acciaio inox temperato microdentate
272	9" 10" 12"	Cesoia sarto
303-8	8"	Forbici tagliacampioni
308-8	8"	Forbici tagliacampioni extra
FTS		Forbici tagliafilo stampata
YH 601		Forbici rasafilo in plastica

FORBICI TEDESCHE "ROBUSO" SOLINGHEN - WISS - VARIE



1461A 5" 6"



1474A 7" 8" 9" 7" 10" 11" 12"



1463AC 5" 6"



1483A 1485A 1484A



1016 12"



1481A 7-3/4"

N. di catalogo N. di descrizione	Misure	Descrizione
1461A	5" 6"	Forbice merciaio lama larga
1474A	7" 8" 9" 10" 11" 12"	Cesoia per sarto - Ted.
1463AC	5" 6"	Forbice curva
1483A		Forbice a molla punta dritta - Wiss
1484A		Forbice a molla tipo economico
1485A		Lame ricambio per 1483A
1016-12	12"	Cesoia per cartoncino
1481A	7-3/4"	Cesoia per cartoncino - Ted.

GESSI IN CAOLINO E IN CERA - AFFILAGESSI

COLORE	CODICE
Bianco	1550A
Nero	1553AN
Rosso	1553AR
Verde	1553AV
Giallo	1553AG
Blu	1553AA
Misti	1551A
Assortiti	1552A

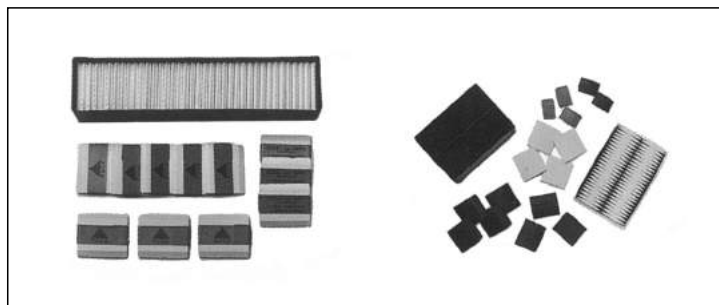
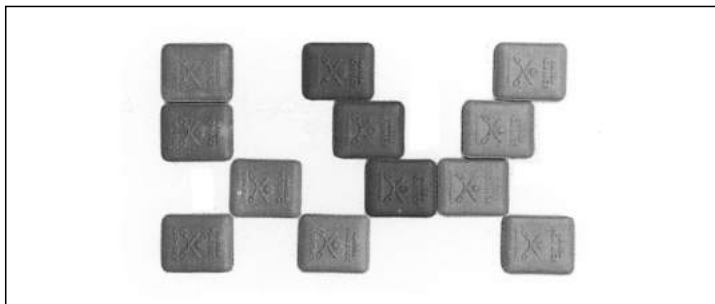

COLORE	CODICE
Bianco	1555A
Nero	1556AN
Rosso	1556AR
Verde	1556AV
Giallo	1556AG
Blu	1556AA
Trasparenti	1557A
Evanescenti	1558A

COLORE	CODICE
Bianco	1560A
Nero	1561AN
Rosso	1561AR
Verde	1561AV
Giallo	1561AG
Blu	1561AA



1580A

N. di catalogo N. di descrizione	Quantitativi per scatola	Descrizione
1550A	100	Gessi caolino bianchi
1551A	100	Gessi caolino misti - metà bianchi - metà colorati
1552A	100	Gessi caolino colori assortiti
1553A	100	Gessi caolino colori singoli
1555A	48	Gessi cera bianchi
1555A	48	Gessi cera colori singoli
1558A	50	Gessi cera evanescenti
1560A	100	Matite alla cera bianche
1561A	100	Matite alla cera colori singoli
1580A		AffilageSSI

SPAZIATORI PER BOTTONI ED ASOLE



1605A



1606A



1607A

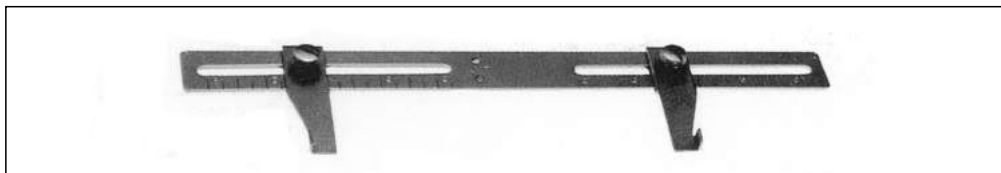

1611A

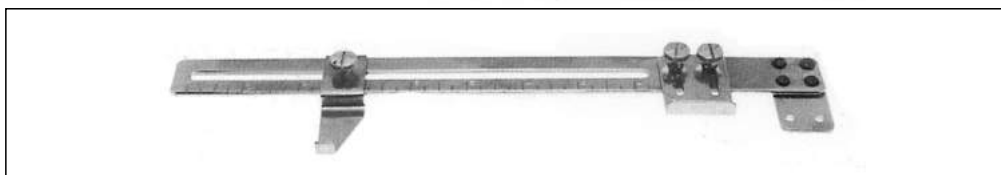

1612A

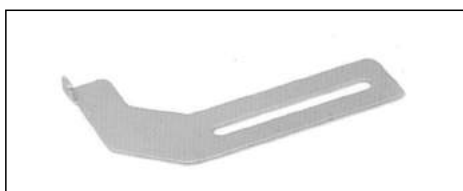

1615A

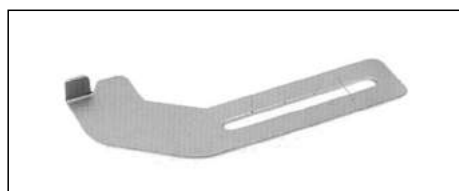

1616A

N. di catalogo N. di descrizione	N. Originale	Descrizione
1602A		Spaziatrice per bottoni sinistro per Singer KL 68, 69, 114, 175
1603A		Spaziatrice per bottoni destro per Singer KL 68, 69, 114, 175
1604A		Spaziatrice doppio per bottoni per Singer
1607A		Spaziatrice doppio per bottoni per Lewis
1605A		Spaziatrice per bottoni sinistro per Lewis
1606A		Spaziatrice per bottoni destro per Lewis
1611A		Spaziatrice per asole orizzontali per Reece
1612A		Spaziatrice per asole verticali per Reece
1615A		Spaziatrice per asole orizzontali per Singer KL 71
1616A		Spaziatrice per asole verticali per Singer KL 71

SPILLI INFLEX ACCIAIO NICHELATI



S5G250



S6G250



S7G1000



SMSC200



SMSG30

SPILLI

N°	mm	Ø
5	28	0,60
6	30	0,60
7	32	0,70

N. di catalogo N. di descrizione	N. Originale	Descrizione
S5G250		Scatola spilli GR 250
S5G500		Scatola spilli GR 500
S5G1000		Scatola spilli GR 1000
S6G250		Scatola spilli GR 250
S6G500		Scatola spilli GR 500
S6G1000		Scatola spilli GR 1000
S7G250		Scatola spilli GR 250
S7G500		Scatola spilli GR 500
S7G1000		Scatola spilli GR 1000
SMSC200		Scatola spilli magnetica capocchia colorata
SMSG30		Scatola spilli magnetica GR 30

AGHI SELLAIO

A-72

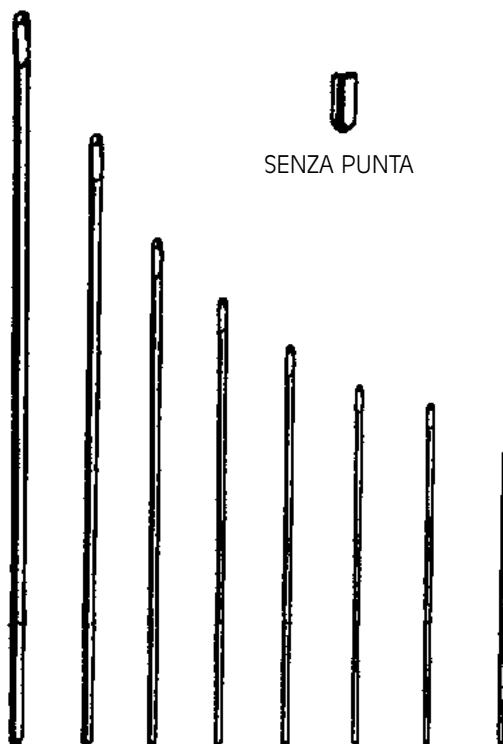
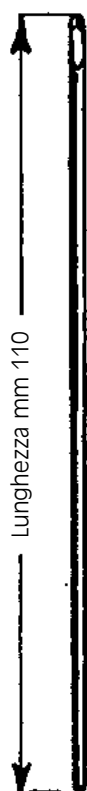

Confezione cartine da 25 aghi

N°	mm	∅
8/0	110	1,70
6/0	100	1,30
4/0	80	1,50
2/0	70	1,30
1	60	1,10
3	55	0,90
4	50	0,90
5	47	0,80
7	41	0,70

A-72-B



Confezione cartine da 25 aghi

N°	mm	∅
4/0	80	1,50
2/0	70	1,30
1	60	1,10

ADLER



9033 Ferro cl. 1296
9033A Alluminio

BERNINA



RB117
cl. 217

BARATTO



HBA-4
20280

DURKOPP

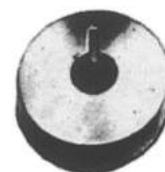

204230 Ferro
cl. 211, 212, 216, 218
221, 2656-06

JUKI



270010
B9117 012 000
cl. DDL 115, 227,
555, DLM 52



204230A Alluminio
cl. 211, 212, 216, 218
221, 2656-06



249372
cl. 227, 249, 380, 541



5701015 Ferro
cl. 570
5701015A Alluminio



B 1809 761 000
cl. LBH 761, 762, 763

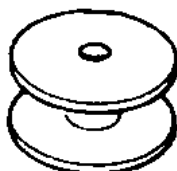

B 9117 552 A00
cl. 5550 A



B 1811 771 000
cl. LBH 771, 781, 782

PFAFF



9033 Ferro
cl. 120, 134, 138, 234,
238, 260, 335, 461,
463, 481, 483



9033A Alluminio
cl. 120, 134, 138, 234,
238, 260, 335, 461,
463, 481, 483

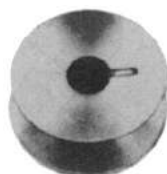

10079 Ferro
cl. 122, 140, 141, 142,
145, 146, 192, 442,
471, 871, 893
10079A Alluminio



20240 Ferro
cl. 3114, 3115, 3116
20240A Alluminio

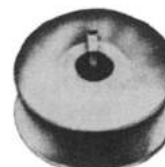

18339 Ferro
cl. 540, 541, 555,
590, 591, 596
18339A Alluminio

NECCHI



52400 Ferro
cl. 750, 752, 812, 813,
830, 831, 840, 885
52400A Alluminio



30430
cl. 900, 902, 925, 952



2996P
2996 Nylon BU
Supernova, Julia



2518
Bobina centrale



204230 Ferro
cl. 860
204230A Alluminio

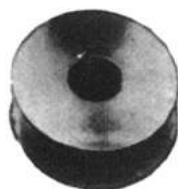

40264 Ferro
cl. 95, 96, 241
40264A Alluminio



270010 Ferro
cl. 400W, 600W

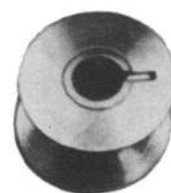

2996 Ferro
cl. 17, 17U, 18, 18U

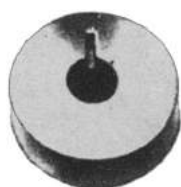

2073
cl. 17, 17U, 18, 18U

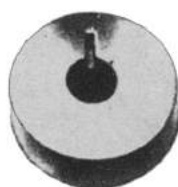

8604
cl. 29, 29K



2518
Bobina centrale



8228
cl. 27, 127

SPOLINE PLASTICA

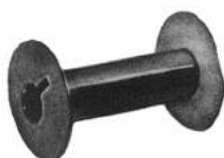

95093
cl. 45K

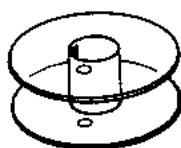

172222
32522P/172222P
172336
Singer 66, 2300, 2500



2996P
2996 Nylon
cl. 16, 31, 44



SCHEDA TECNICA CB 1000

Novità

- Lampadina alogena 12 volt. 5 wat.
- Interruttore sulla 220 volt. microfuso.
- Cavo della 12 volt. cm. 180.
- Porta lampada teflonato.
- **Trasformatore ingresso 220 volt. uscita 11,6 volt. stabilizzata, in questo modo si evita che la lampadina si bruci, nei casi di sbalzi di corrente.**

CB1000

N. di catalogo N. di descrizione	N. Originale	Descrizione
CB1000		Riflettore completo
CB1000T		Trasformatore
CB1000L		Lampadina alogena per riflettore

INFILA AGHI - SALVADITA PER PIEDINI



INFILA



SD5



EZ-IN



SD6



PERFECTO



SD7

N. di catalogo N. di descrizione	N. Originale	Descrizione
INFILA		
EZ-IN		
PERFECTO		
SD5		
SD6		
SD7		

Apparecchiature

- Apparecchi orlatori
- Apparecchi per sproni
- Apparecchi per cerniere
- Apparecchi bordatori
- Apparecchi collaretto
- Apparecchi per cinture
- Apparecchi vari
- Apparecchi bordatori per pelle
- Apparecchi ribattitori
- Pinza attacca bottoni
- Guide varie
- Apparecchi tiranastri
- Porta rocchettini

APPARECCHI ORLATORI

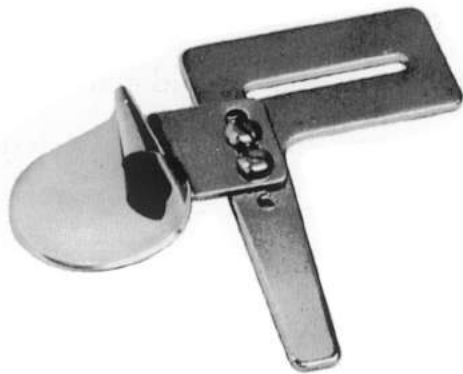

2000A

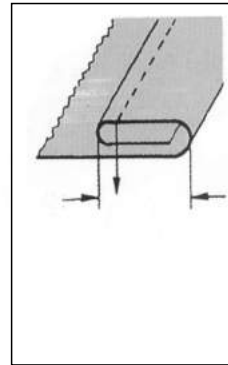

MISURE	
ORLO FINITO	
mm 1,6	(1/16")
mm 3,2	(1/8")
mm 4,8	(3/16")
mm 6,4	(1/4")
mm 9,5	(3/8")
mm 12,7	(1/2")

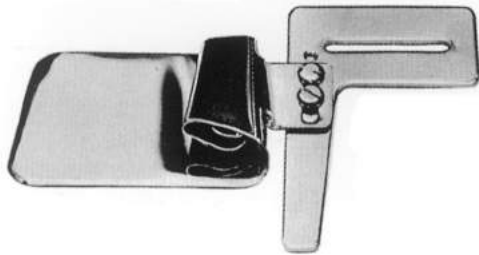

2100A

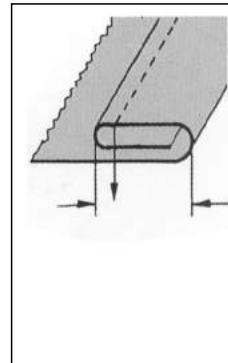

MISURE		
ORLO FINITO		
mm 3	mm 10	mm 18
mm 4	mm 11	mm 20
mm 5	mm 12	mm 25
mm 6	mm 13	mm 30
mm 7	mm 14	mm 35
mm 8	mm 15	mm 40
mm 9	mm 16	

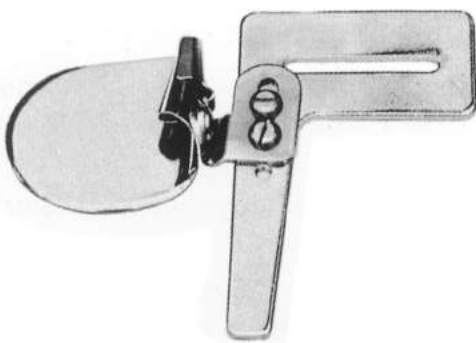

2001A

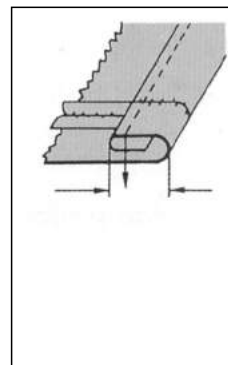

MISURE	
ORLO FINITO	
mm 1,6	(1/16")
mm 3,2	(1/8")
mm 4,8	(3/16")
mm 6,4	(1/4")

N. di catalogo N. di descrizione	Descrizione
2000A	Orlatore doppia piega superiore
2100A	Orlatore doppia piega superiore con fermo
2001A	Orlatore doppia piega superiore con molla

APPARECCHI ORLATORI

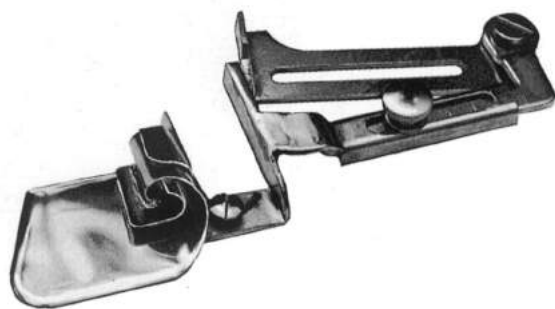

2002A

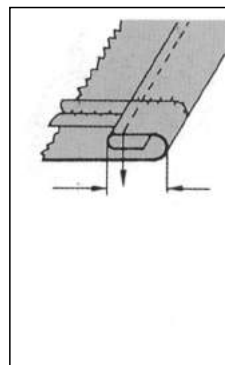

MISURE	
ORLO FINITO	
mm 1,6	(1/16")
mm 3,2	(1/8")
mm 4,8	(3/16")
mm 6,4	(1/4")
mm 9,5	(3/8")
mm 12,7	(1/2")

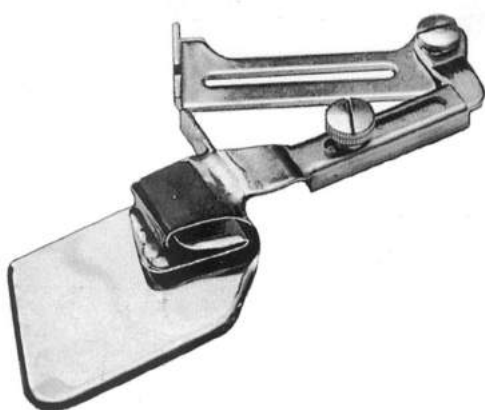

2003A

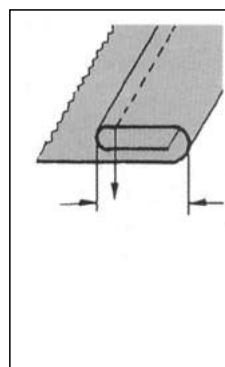

MISURE		
ORLO FINITO		
mm 4	mm 26	mm 75
mm 6	mm 28	mm 80
mm 10	mm 32	mm 90
mm 12	mm 38	mm 100
mm 16	mm 45	
mm 19	mm 50	
mm 22	mm 63	



2004A

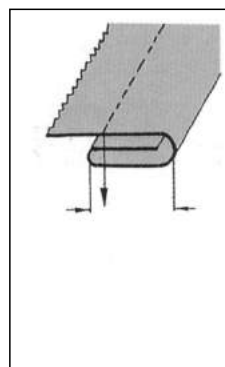

MISURE	
ORLO FINITO	
mm 6	(1/4")
mm 9	(3/8")
mm 12	(1/2")
mm 15	(5/8")
mm 19	(3/4")
mm 22	(7/8")
mm 25	(1")

N. di catalogo N. di descrizione	Descrizione
2002A	Orlatore doppia piega con molla
2003A	Orlatore doppia piega superiore con guida apribile
2004A	Orlatore doppia piega inferiore con guida apribile

APPARECCHI ORLATORI

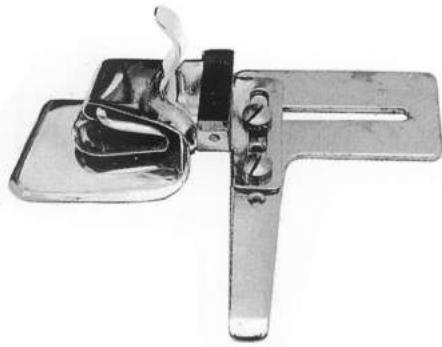

2005A

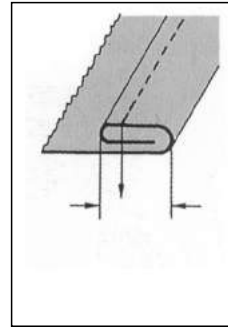

MISURE
ORLO FINITO
mm 6 (1/4")
mm 10 (3/8")
mm 12 (1/2")
mm 16 (5/8")
mm 20 (3/4")
mm 22 (7/8")
mm 25 (1")
mm 30 (1-1/8")
mm 40

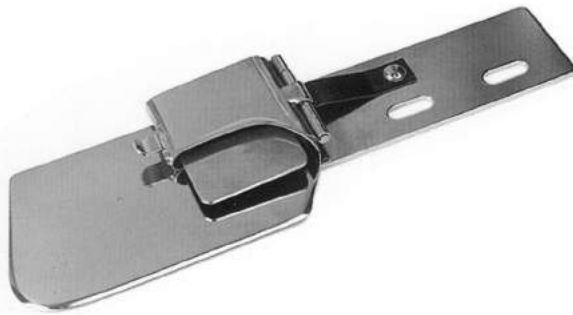

2006A

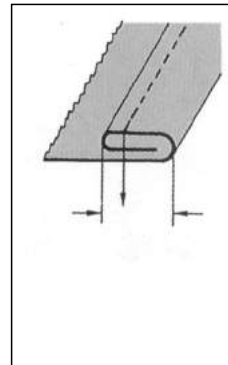

MISURE
ORLO FINITO
mm 50 (2")
mm 56 (2-1/4")
mm 63 (2-1/2")

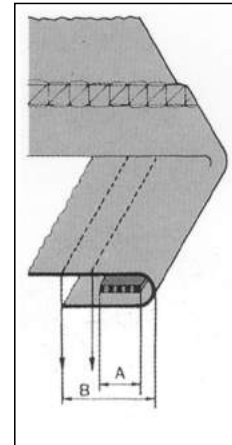
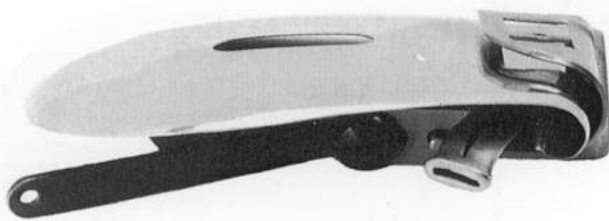

S-2007A

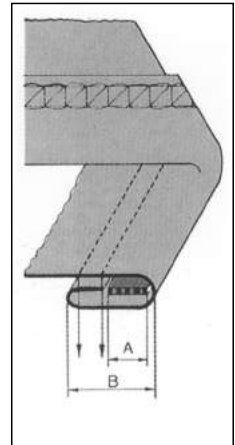

D-2007A

N. di catalogo N. di descrizione	Descrizione
2005A	Orlatore apribile doppia piega superiore
2006A	Orlatore apribile a cerniera doppia piega superiore
S-2007A	Orlatore passa elastico piega semplice inferiore
D-2007A	Orlatore passa elastico piega doppia inferiore

APPARECCHI ORLATORI

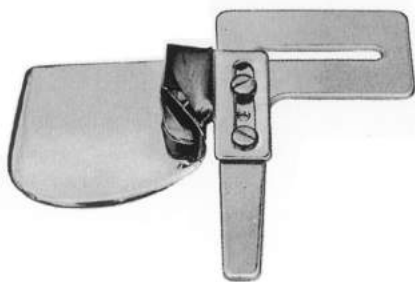

2008A

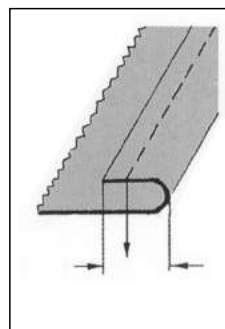

MISURE
ORLO FINITO
mm 4 (3/16")
mm 6 (1/4")
mm 9 (3/8")
mm 12 (1/2")
mm 16 (5/8")
mm 19 (3/4")

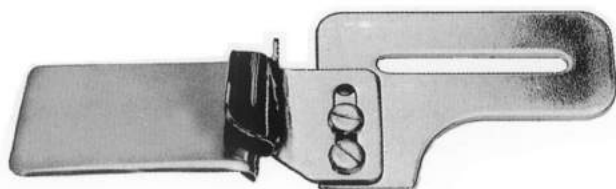

2108A

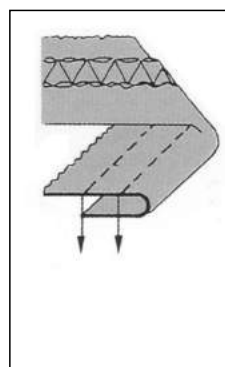

MISURE
ORLO FINITO
mm 10
mm 15
mm 20
mm 25
mm 30
mm 35
mm 40

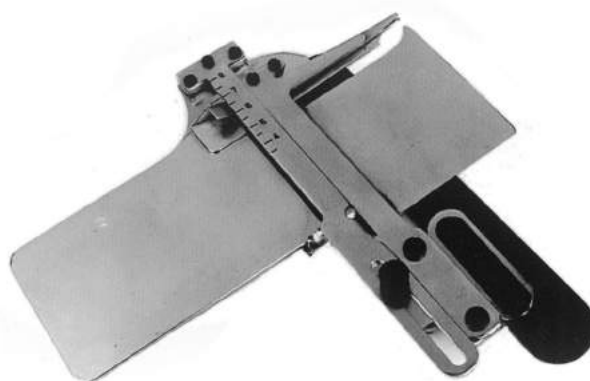

2047A

MISURE
ORLO FINITO
Da 1 a 5 cm - tipo A
Da 4 a 8 cm - tipo B

N. di catalogo N. di descrizione	Descrizione
2008A	Orlatore piega semplice superiore
2108A	Orlatore piega semplice inferiore
2047A-Tipo A	Orlatore piega doppia superiore regolabile da 1 a 5 cm
2047A-Tipo B	Orlatore piega doppia superiore regolabile da 4 a 8 cm

APPARECCHI ORLATORI



2039A
B2039A Apribile

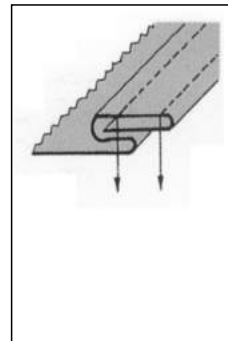

MISURE
ORLO FINITO
mm 32
mm 35
mm 48

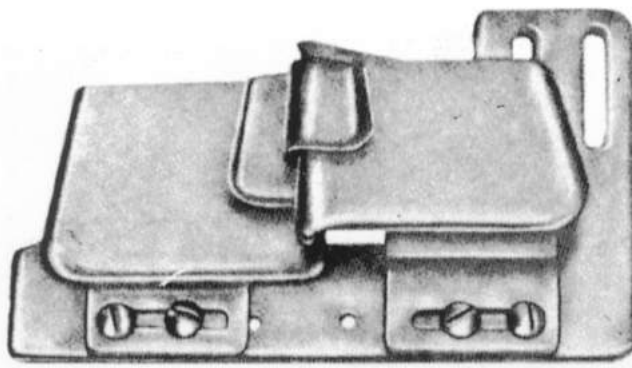

D-2037A

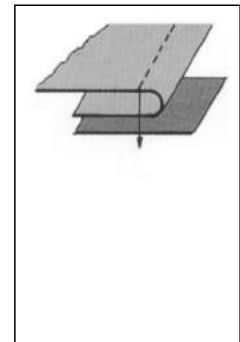

Destro



S-2037A

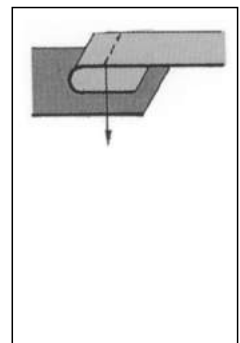

Sinistro

N. di catalogo
N. di descrizione

Descrizione

A-2039A	Orlatore per cannoncino camice
B-2039A	Orlatore per cannoncino camice apribile
D-2037A	Apparecchio per sproni semplici regolabile destro
S-2037A	Apparecchio per sproni semplici regolabile sinistro

APPARECCHI PER SPRONI E CERNIERE

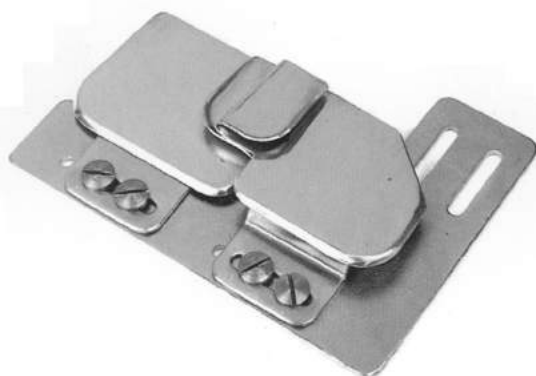

2034A

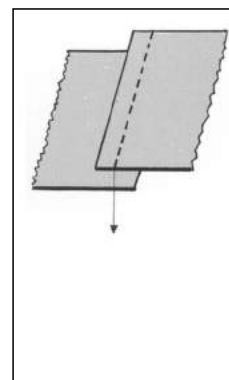

2038A

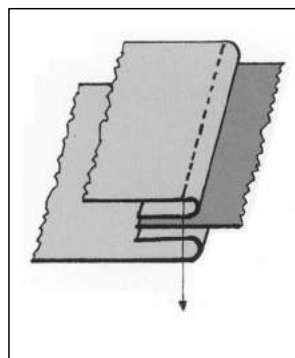

D-Destro

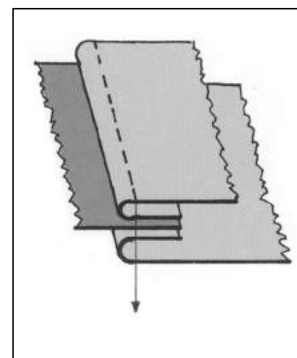

S-Sinistro

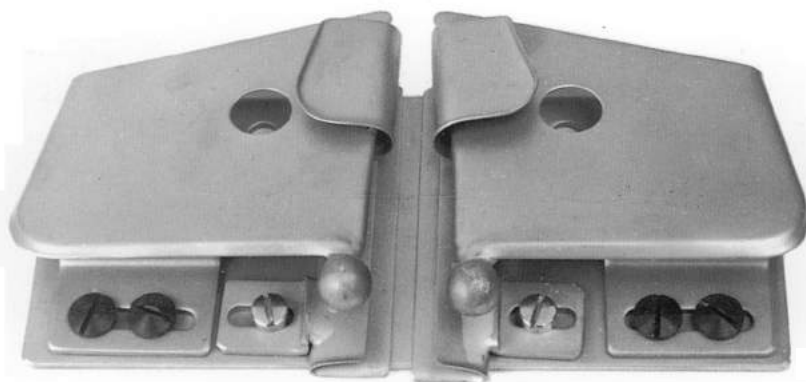

2045A

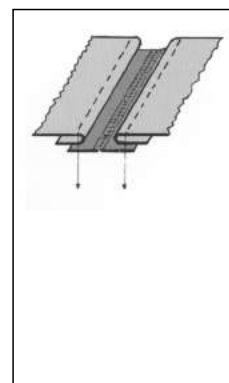

N. di catalogo N. di descrizione	Descrizione
2034A	Apparecchio per sproni semplici
D-2038A	Apparecchio per sproni doppio destro
S-2038A	Apparecchio per sproni doppio sinistro
2045A	Apparecchio per cerniere regolabile con attacco universale

APPARECCHI BORDATORI

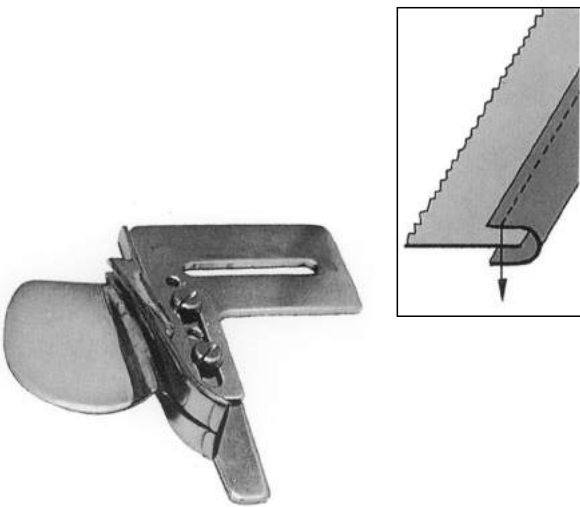

2009A

misure 3/8", 1/2", 5/8", 3/4", 7/8", 1"

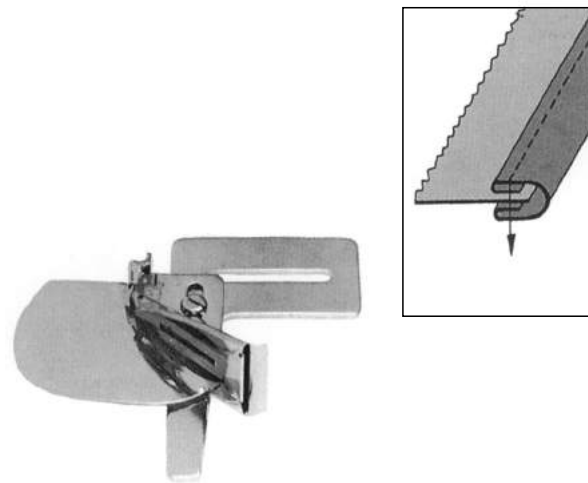

2010A

misure 5/8", 3/4", 7/8", 1", 1-1/8", 1-1/4", 1-1/2"

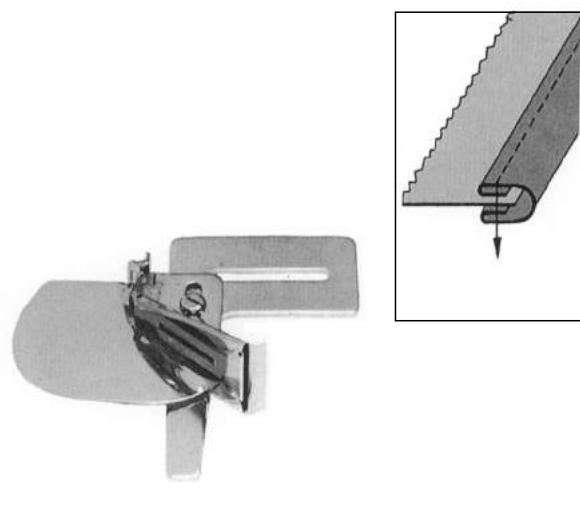

2110A

misure 3/4", 7/8", 1"

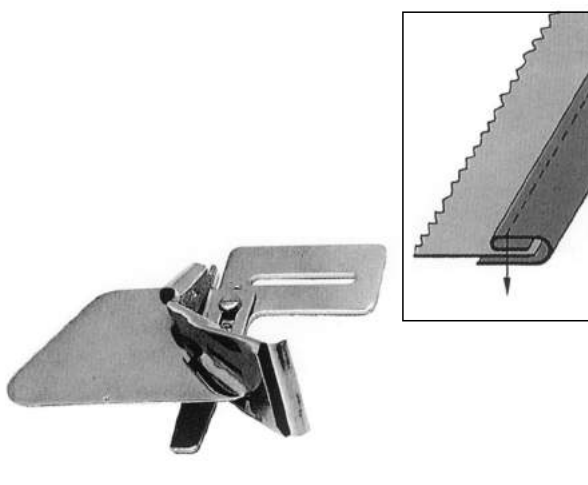

2120A

misure mm 20, mm 22, mm26

N. di catalogo N. di descrizione	Descrizione
2009A	Bordatore semplice per nastri dritto
2010A	Bordatore doppio per nastri in stoffa
2110A	Bordatore doppio per nastri in plastica leggera
2120A	Bordatore doppio-semplce per nastri in stoffa

APPARECCHI BORDATORI

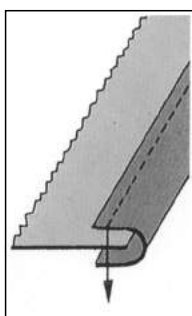

2022A

misure mm 19, mm 22, mm 25, mm 30, mm 35, mm 40

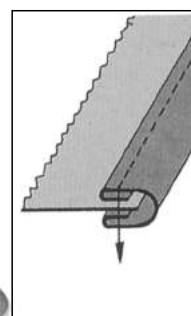
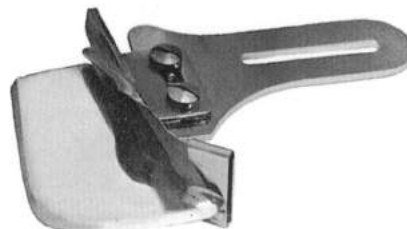

2023A

misure mm 19, mm 22, mm 25, mm 30, mm 35, mm 40

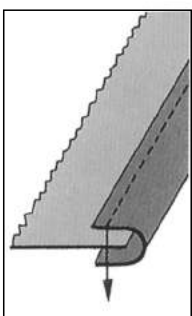

2012A

misure mm 14, mm 16, mm 19, mm 22, mm 25, mm 30
mm 35, mm 40, mm 50, mm 60

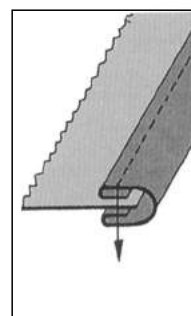
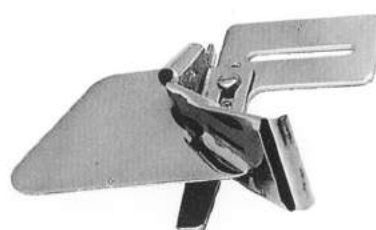

2013A

misure mm 19, mm 22, mm 25, mm 30, mm 35, mm 40

N. di catalogo N. di descrizione	Descrizione
2022A	Bordatore semplice per nastri in plastica
2023A	Bordatore doppio per nastri in plastica
2012A	Bordatore semplice extra per nastri in plastica
2013A	Bordatore doppio extra per nastri in plastica

APPARECCHI BORDATORI



2014A

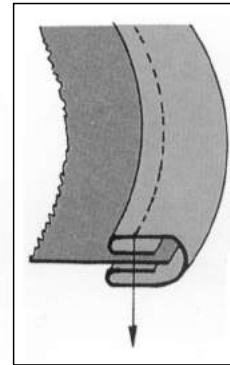

MISURE	
mm 16	mm 35
mm 18	mm 38
mm 20	mm 40
mm 22	mm 45
mm 25	mm 50
mm 28	
mm 30	
mm 32	



2015A

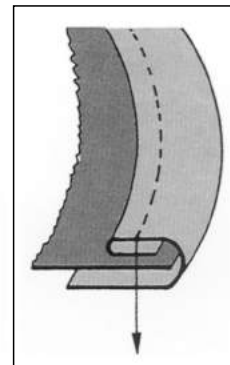

MISURE	
mm 16	
mm 19	
mm 22	
mm 25	
mm 28	



2016A

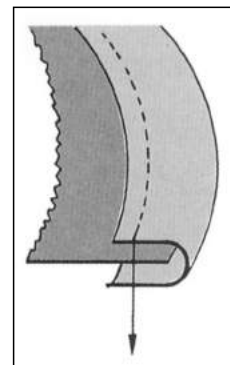

MISURE	
ORLO FINITO	
mm 12	mm 28
mm 14	mm 30
mm 16	mm 32
mm 18	mm 35
mm 20	mm 38
mm 22	
mm 25	

N. di catalogo
N. di descrizione

Descrizione

2014A	Bordatore doppio completo di placca griffa e piedino compensatore
2015A	Bordatore doppio-semplce completo di placca griffa e piedino compensatore
2016A	Bordatore semplice completo di placca griffa e piedino compensatore

APPARECCHI BORDATORI

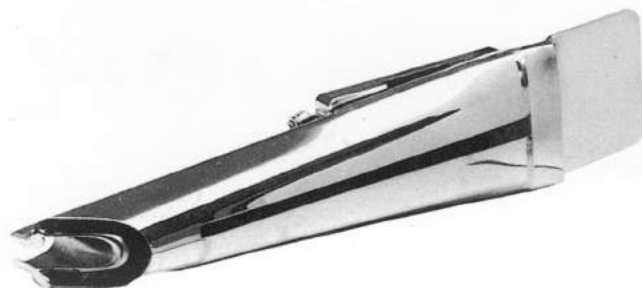

A-2017A

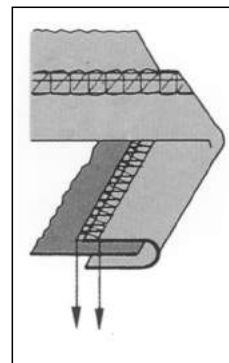

B-2017A

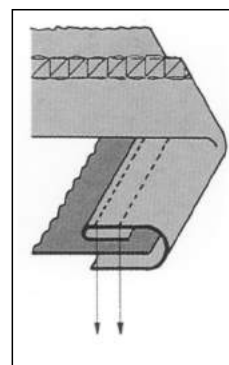

C-2017A

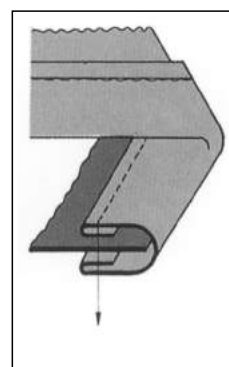

N. di catalogo N. di descrizione	Descrizione
A-2017A	Bordatore per collaretto piega semplice
B-2017A	Bordatore per collaretto piega doppia-semple
C-2017A	Bordatore per collaretto piega doppia - misure mm 22 - 25 - 28 - 30 - 32 - 35 - 38 - 42 - 45 - 50 - 58 - 60

APPARECCHI BORDATORI PER CINTURE

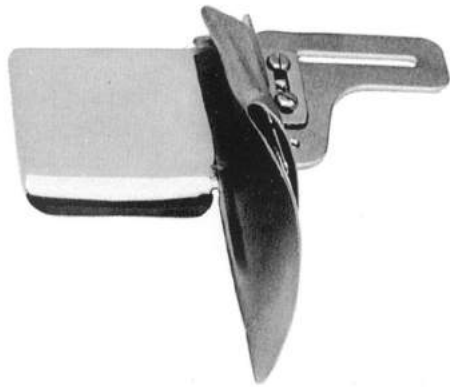

2028A

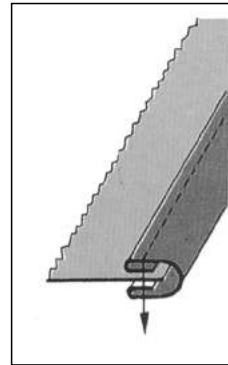

MISURE	
ENTR.	LAV. FIN.
mm 45	mm 15
mm 55	mm 20
mm 70	mm 25
mm 80	mm 30
mm 90	mm 35
mm 100	mm 40
mm 110	mm 45
mm 120	mm 50



2029A

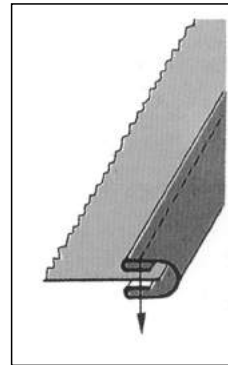

MISURE	
ENTR.	LAV. FIN.
mm 45	mm 15
mm 52	mm 18
mm 58	mm 20
mm 64	mm 22
mm 70	mm 24



2033A

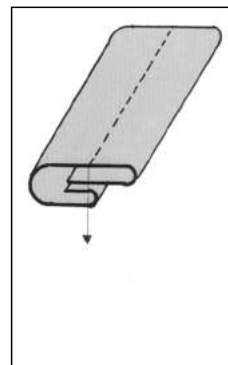

MISURE	
ENTR.	LAV. FIN.
mm 30	mm 13
mm 35	mm 14
mm 45	mm 20
mm 50	mm 22
mm 60	mm 27
mm 70	mm 32
mm 80	mm 37

N. di catalogo
N. di descrizione

Descrizione

2028A	Bordatore per cinture tessuto medio
2029A	Bordatore per cinture tessuto leggero
2033A	Bordatore per cinture cucitura centrale

APPARECCHI BORDATORI PER CINTURE



2030A

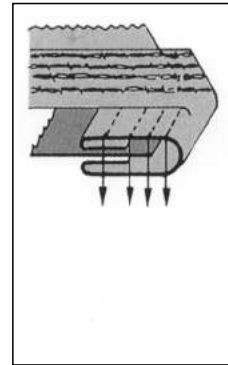

MISURE	
ENTR.	LAV. FIN.
mm 70	mm 25
mm 80	mm 30
mm 95	mm 36
mm 105	mm 42
mm 110	mm 44
SPESSORE	
L = leggero	
M = medio	
H = pesante	

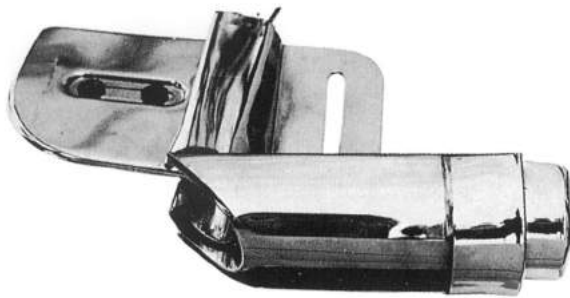

2130A

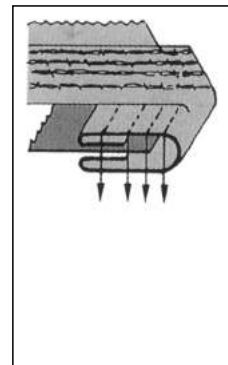

MISURE	
ENTR.	LAV. FIN.
mm 95	mm 36
mm 105	mm 42
SPESSORE	
L = leggero	
M = medio	
H = pesante	



2025A

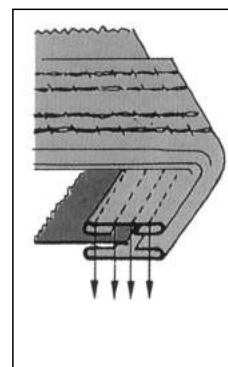

MISURE	
ENTR.	LAV. FIN.
mm 50	mm 30
mm 57	mm 37
mm 63	mm 43

N. di catalogo N. di descrizione	Descrizione
2030A	Bordatore ad angolo per cinture attacco universale
2130A	Bordatore ad angolo per cinture attacco Rimoldi
2025A	Bordatore per cinture a due strati

APPARECCHI VARI



2031A

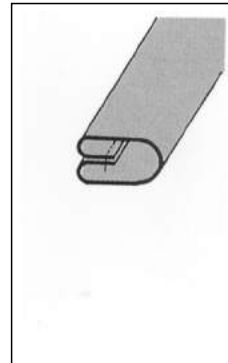

MISURE	
ENTR.	LAV. FIN.
mm 16	mm 4
mm 19	mm 5
mm 22	mm 5,5
mm 25	mm 6
mm 28	mm 8
mm 32	mm 9,5
mm 38	mm 11

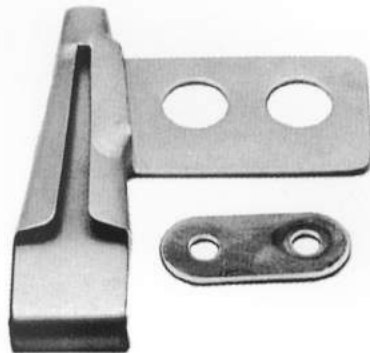

2032A

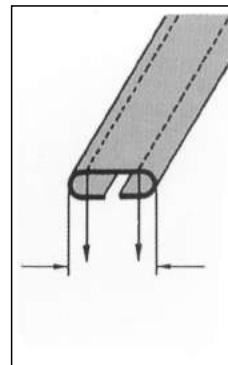

MISURE	
ENTR.	LAV. FIN.
mm 19	mm 9,5
mm 22	mm 11
mm 25	mm 12,5
mm 28	mm 14
mm 30	mm 15
mm 32	mm 16
mm 35	mm 17,5
mm 40	mm 20
mm 45	mm 22,5
mm 50	mm 25

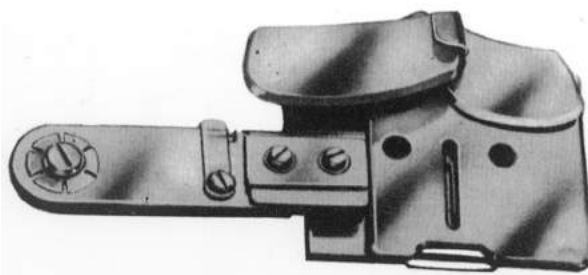

2044A

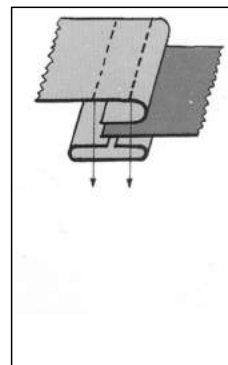

MISURE
3/16"
1/4"

N. di catalogo
N. di descrizione

Descrizione

2031A	Apparecchio spaghetti
2032A	Piegatore per passanti
2044A	Apparecchio per bordure di corsetti

APPARECCHI VARI

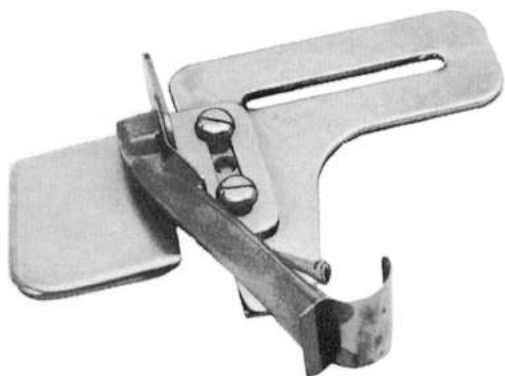

2027A

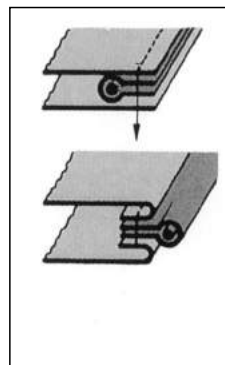

MISURE
MISURE PROFILO
mm 19
mm 22
mm 25
mm 30

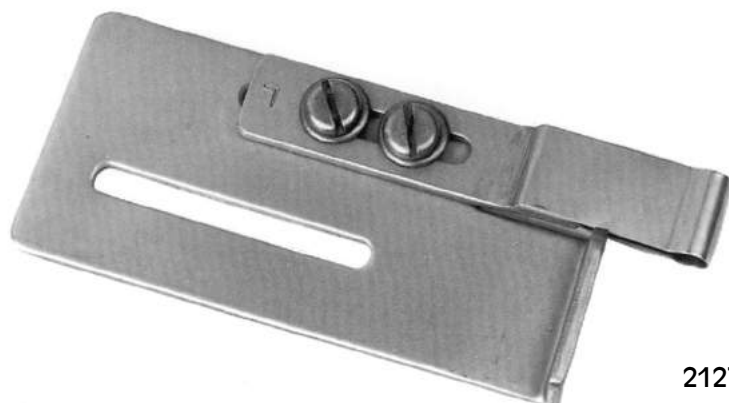

2127A

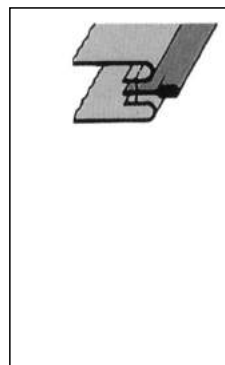

SPESSORE
Spessore leggero
Spessore medio
Spessore pesante

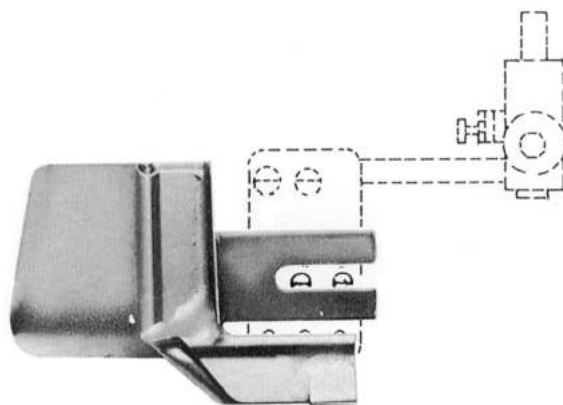

2129A

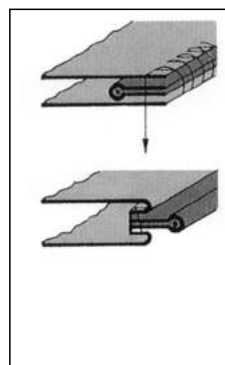

MISURE
MISURE PROFILO
mm 8
mm 10
mm 12
mm 15

N. di catalogo N. di descrizione	Descrizione
2027A	Guida per profilo con inserimento cordonetto
2127A	Guida regolabile per inserimento profilo prefabbricato
2129A	Guida per inserimento profilo prefabbricato per macchine tagliacuci

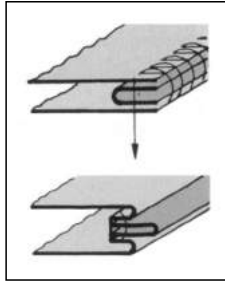

2026A

MISURE
MISURE PROFILO
mm 19
mm 22
mm 25
mm 30

PR

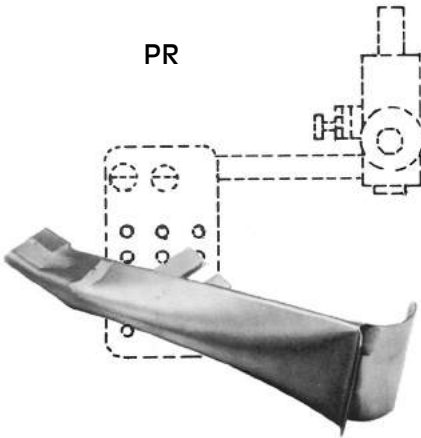

PRI

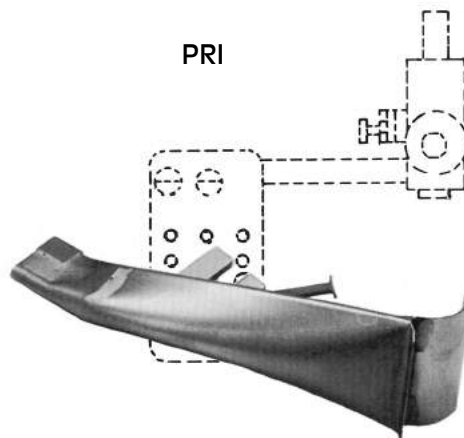

MISURE
MISURE PROFILO
mm 19
mm 22
mm 25
mm 30

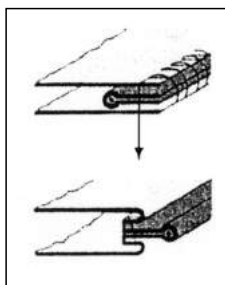

P2129A

MISURE
MISURE PROFILO
mm 8
mm 10
mm 12
mm 15

N. di catalogo
N. di descrizione

Descrizione

2026A	Guida inserimento profilo per macchine piane
PR	Guida inserimento profilo per macchine tagliacuci
PRI	Guida per profilo con inserimento cordonetto
P2129A	Guida inserimento profilo prefabbricato per macchine piane



1323A



1326A



1324A

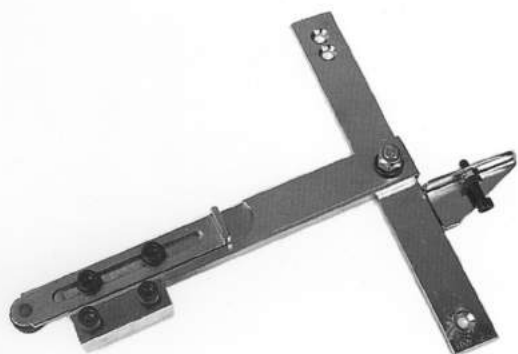

2150A



2160A

N. di catalogo N. di descrizione	Descrizione
1323A	Guida ribaltabile nuovo metallo
1324A	Guida ribaltabile micrometrica
1326A	Blocchetto porta bordatore
2150A	Guida porta bordatore pelle per macchina piana
2160A	Guida porta bordatore pelle per macchina bordatrice ADLER 69
2161A	Guida porta bordatore pelle per macchina bordatrice NE 840-PF335

GUIDE E BORDATORI PER PELLE

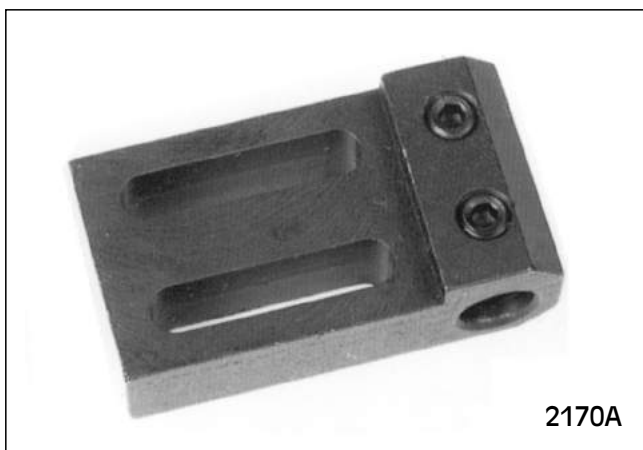

2170A

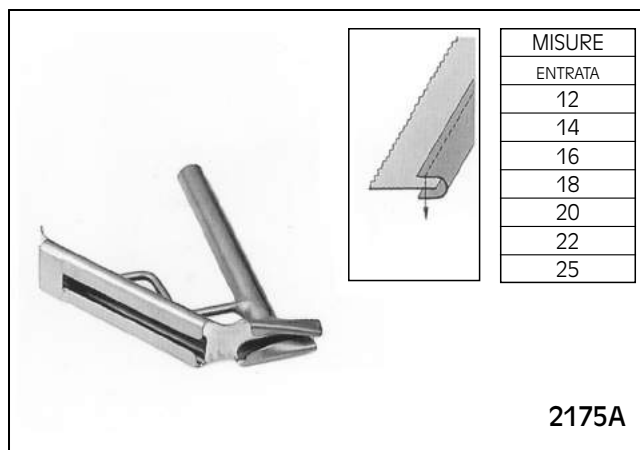

2175A

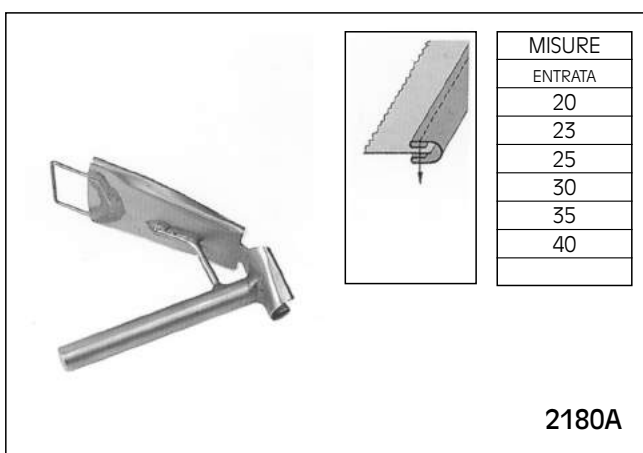

2180A

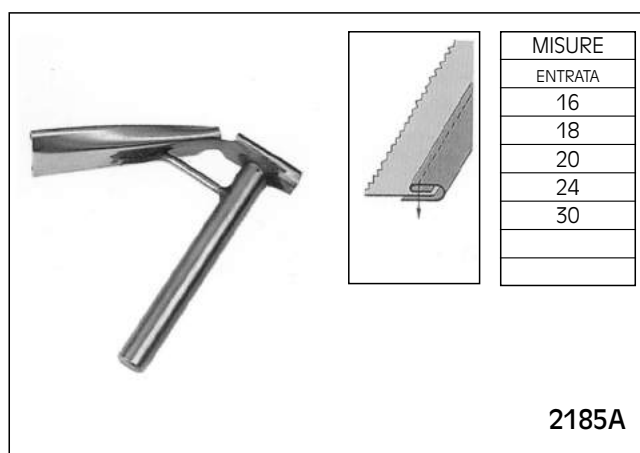

2185A

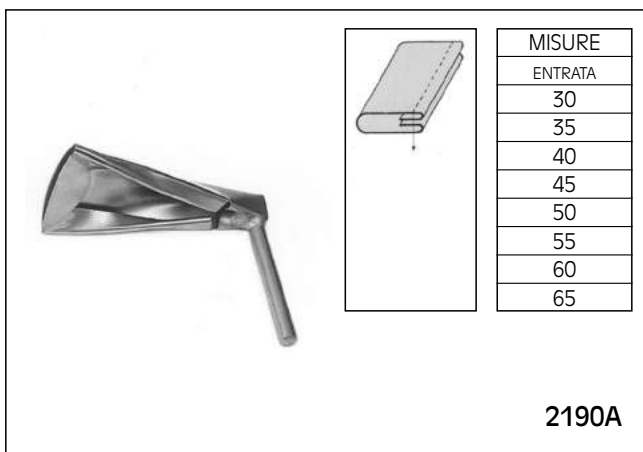

2190A

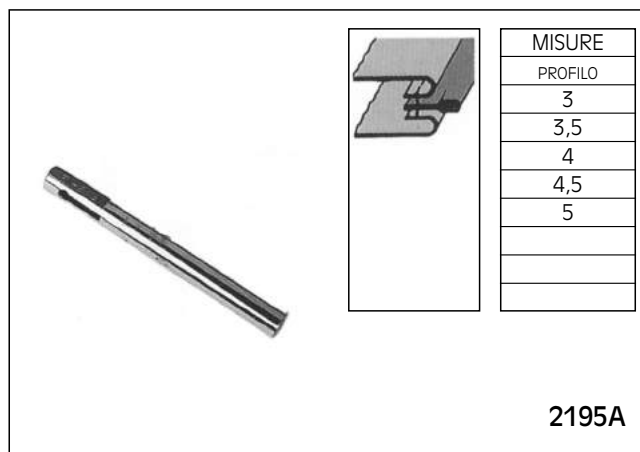

2195A

N. di catalogo N. di descrizione	Descrizione
2170A	Squadretta attacco per bordare pelle
2175A	Bordatore pelle taglio vivo
2180A	Bordatore pelle doppia piega
2185A	Bordatore pelle doppio-semple
2190A	Bordatore pelle tracolla
2195A	Bordatore pelle profilo prefabbricato

BORDATORI PELLE

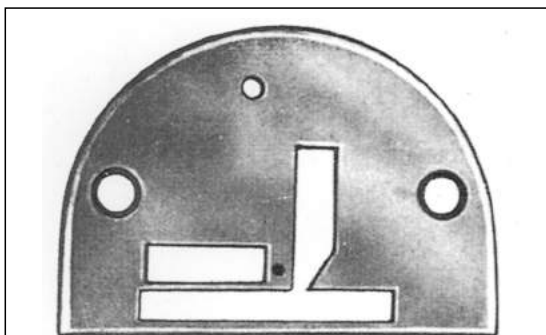

2018A

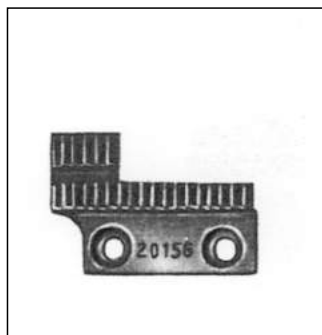

2019A



2020A

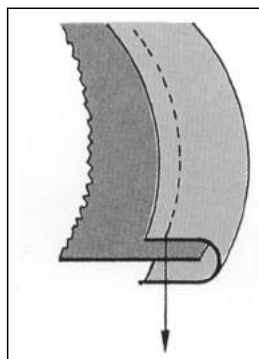

2021A

I bordatori si possono fornire in tutte le misure normali. Per lavori e misure è consigliabile inviare campioni della fettuccia e relativo spessore del materiale cui va applicata la fettuccia stessa.

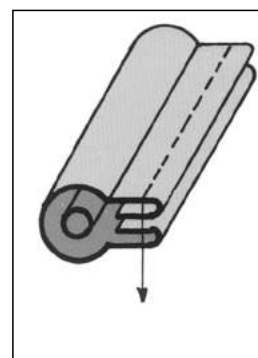

2035A

N. di catalogo N. di descrizione	Descrizione
2018A	Placca per beccuccio bordatore
2019A	Griffa per beccuccio bordatore
2020A	Beccuccio bordatore speciale
2021A	Beccuccio bordatore normale
2035A	Bordatore per maniglie

RIBATTITORI

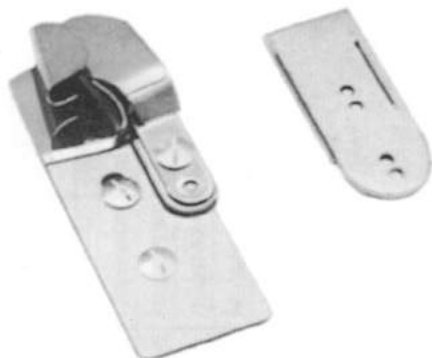

2040A

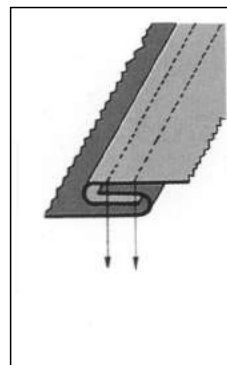

MISURE
RIMBOCCATURA
mm 4,8 (3/16") L
mm 4,8 (3/16") M
mm 4,8 (3/16") MH
mm 4,8 (1/4") H
mm 6,4 (1/4") L
mm 6,4 (1/4") M
mm 6,4 (1/4") MH
mm 6,4 (1/4") H



2140A

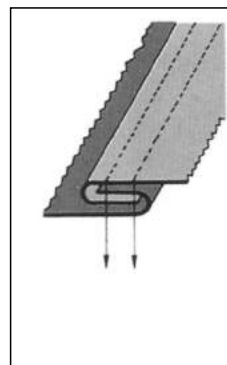

MISURE
RIMBOCCATURA
mm 4,8 (3/16") L
mm 4,8 (3/16") M
mm 4,8 (3/16") MH
mm 4,8 (1/4") H
mm 6,4 (1/4") L
mm 6,4 (1/4") M
mm 6,4 (1/4") MH
mm 6,4 (1/4") H

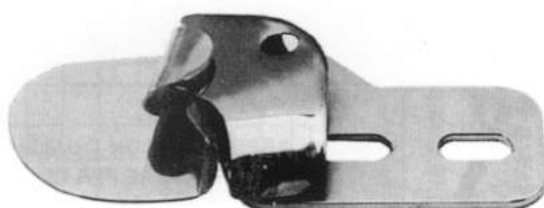

2041A

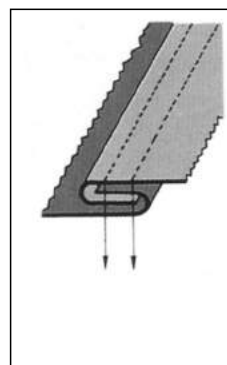

MISURE
RIMBOCCATURA
mm 4,8 (3/16") L
mm 4,8 (3/16") M
mm 4,8 (3/16") MH
mm 4,8 (1/4") H
mm 6,4 (1/4") L
mm 6,4 (1/4") M
mm 6,4 (1/4") MH
mm 6,4 (1/4") H

N. di catalogo
N. di descrizione

Descrizione

2040A	Ribattitore per Singer KI 231-251
2140A	Ribattitore per Singer KI 231-25
2041A	Ribattitore per Singer KI 147-253-262

RIBATTITORI

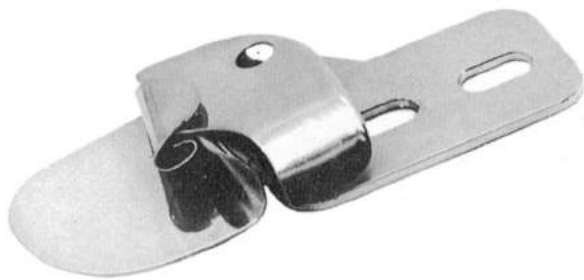

2042A

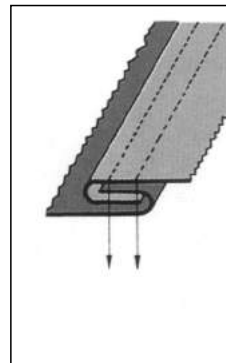

MISURE
RIMBOCCATURA
mm 4,8 (3/16") L
mm 4,8 (3/16") M
mm 4,8 (3/16") MH
mm 4,8 (1/4") H
mm 6,4 (1/4") L
mm 6,4 (1/4") M
mm 6,4 (1/4") MH
mm 6,4 (1/4") H

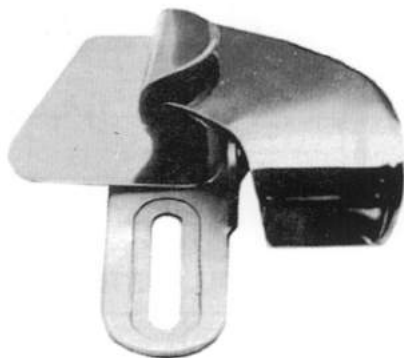

2043A

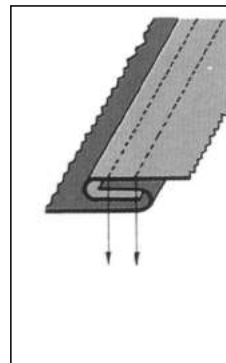

MISURE
RIMBOCCATURA
mm 4,8 (3/16") L
mm 4,8 (3/16") M
mm 4,8 (3/16") MH
mm 4,8 (1/4") H
mm 6,4 (1/4") L
mm 6,4 (1/4") M
mm 6,4 (1/4") MH
mm 6,4 (1/4") H

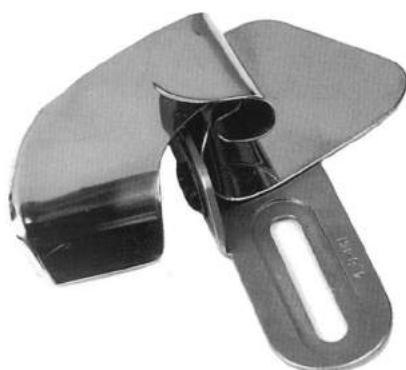

2143A

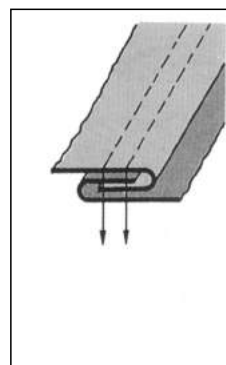

MISURE
RIMBOCCATURA
mm 4,8 (3/16") L
mm 4,8 (3/16") M
mm 4,8 (3/16") MH
mm 4,8 (1/4") H
mm 6,4 (1/4") L
mm 6,4 (1/4") M
mm 6,4 (1/4") MH
mm 6,4 (1/4") H

N. di catalogo N. di descrizione	Descrizione
2042A	Ribattitore per Union 51400
2043A	Ribattitore per Pfaff-Singer
2143A	Ribattitore per Pfaff-Singer inverso

PINZA PER ATTACCA BOTTONI

PER BOTTONI CON GAMBO - KL 175 - (completa)

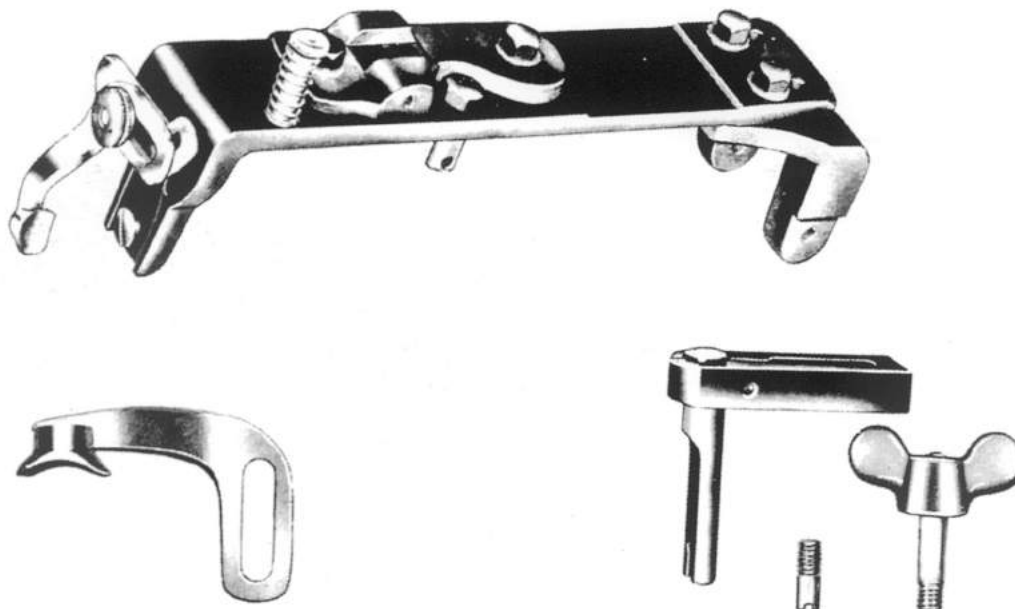

2064A



2067A



2068A



2069A



2070A



2071A



2073A

N. di catalogo N. di descrizione	Descrizione
2064A	Pinza per bottoni con gambo per macchina Singer Kl. 175
2067A	Branca per pinza 7/32"
2068A	Branca per pinza 5/16"
2069A	Branca per pinza 3/8"
2070A	Branca per pinza 1/2"
2071A	Branca per pinza per occhiello in ferro
2073A	Branca per pinza da lavoro per bottoni speciali

PINZA PER ATTACCA BOTTONI

PER BOTTONI CON GAMBO - "LEWIS" KL200 (completa)

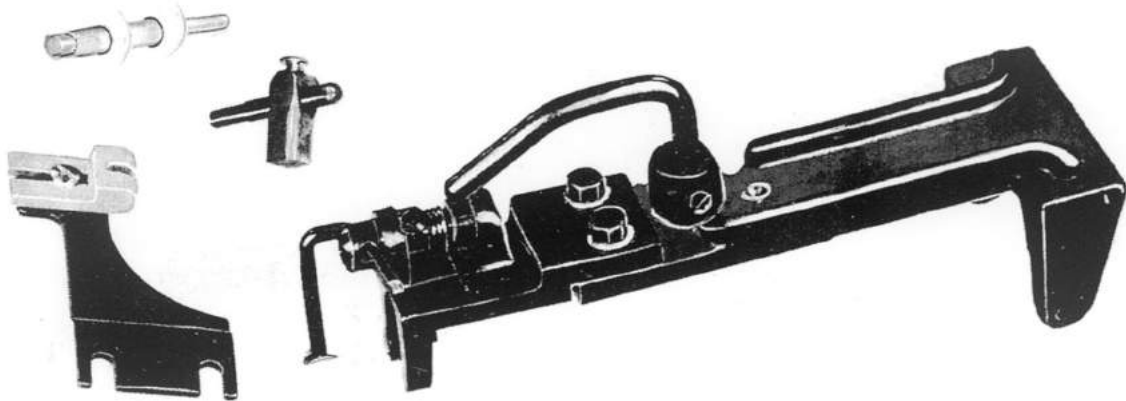

2075A VM



2072A



2074A



2090A



2091A



2092A



2093A

N. di catalogo N. di descrizione	Descrizione
2075A VM	Pinza per bottoni con gambo per macchina Lewis Kl. 200 con branca normale
2075A NM	Pinza per bottoni con gambo per macchina Lewis Kl. 200 con branca speciale
2072A	Branca normale per pinza 2075A
2074A	Branca da lavorare per bottoni speciali
2090A	Branca regolabile mod. 501
2091A	Branca regolabile mod. 502
2092A	Branca regolabile mod. 503
2093A	Branca regolabile mod. 200-20

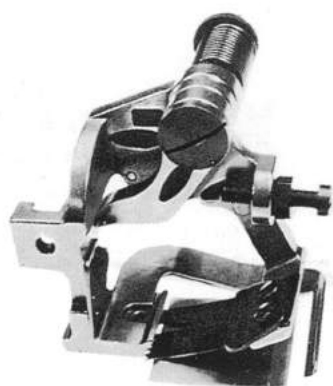

2046A

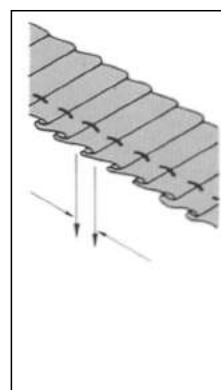

2096A

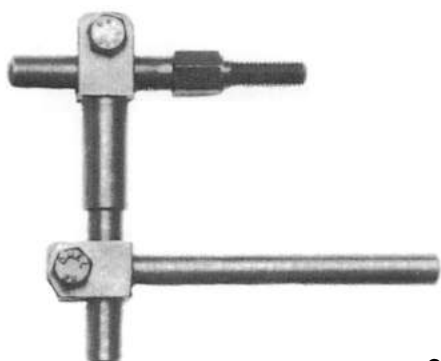
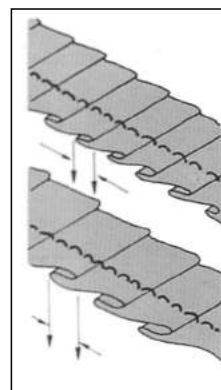

2097A

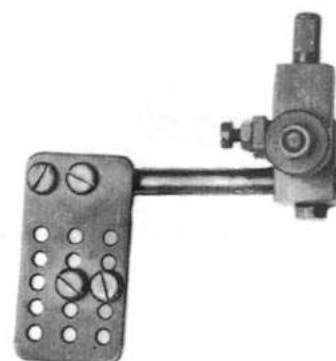

2098A

N. di catalogo N. di descrizione	Descrizione
2046A	Arricciatore universale mod. normale
2096A	Arricciatore universale mod. extra regolabile
2097A	Attacco universale normale
2098A	Attacco per tagliacuci Rimoldi

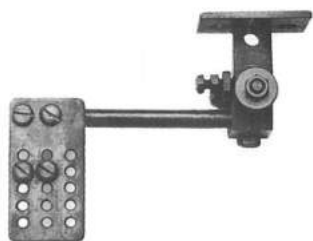

F 1102



F 1104



F 1114



F 1112



F 1100

N. di catalogo N. di descrizione	Descrizione
F 1102	Attacco per taglia-cuci Brother
F 1104	Attacco per taglia-cuci Juki
F 1114	Attacco per taglia-cuci W & G nuovo tipo
F 1112	Attacco per taglia-cuci W & G vecchio tipo
F 1100	Attacco per taglia-cuci Yamato

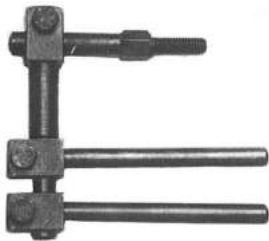

F 1111



F 1103

N. di catalogo N. di descrizione	Descrizione
F 1111	Attacco universale doppio
F 1103	Attacco per taglia-cuci Union Special

APPARECCHI TIRANASTRI

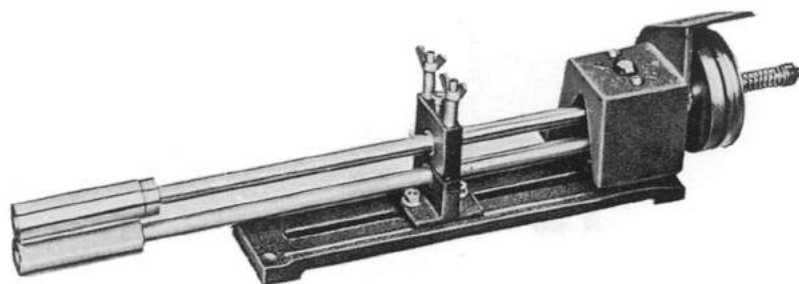

2076A

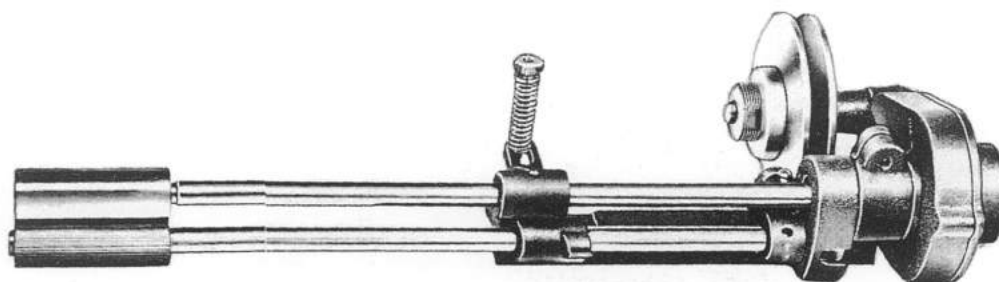

2079A

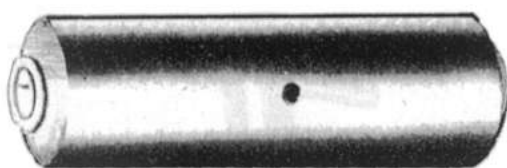

Rulli per detti

si forniscono nelle diverse
lunghezze o spessori a
superficie liscia - zigrinata
o rivestiti in gomma

2081A

N. di catalogo N. di descrizione	Descrizione
2076A	Tiranastrì normale
2079A	Tiranastrì velocità variabile
2081A G	Rulli in gomma 3"
2081A Z	Rulli zigrinati 3"
2081A L	Rulli lisci 3"

« KRIKO »

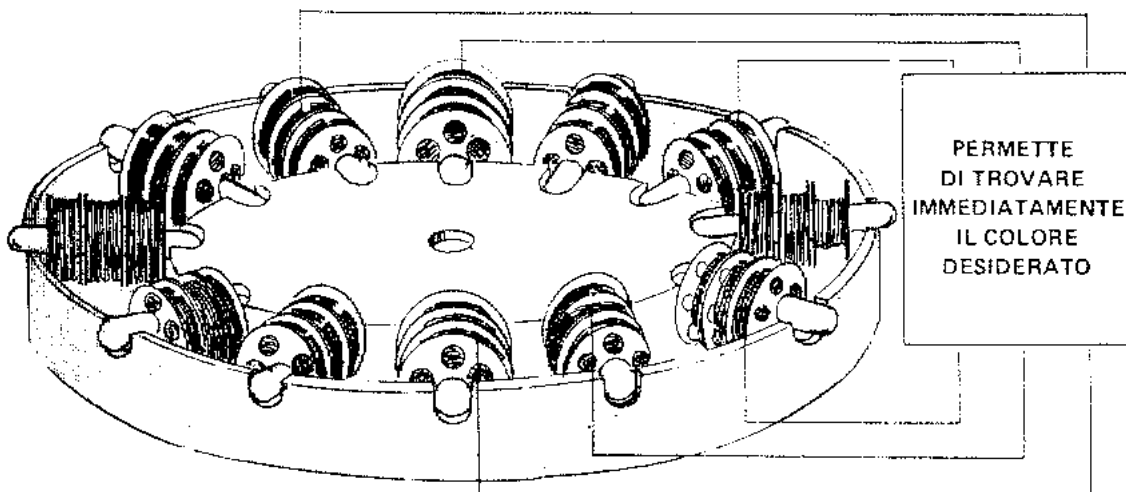

PORTA

Il porta-rocchetti KRIKO, che può essere installato su tutte le macchine per cucire industriali, si fissa con una semplice vite da legno sotto o sopra la tavola, oppure sulla macchina.

Vantaggi:

- Non si perdono più i rocchetti
- Non si devono più ricercare i colori
- Guadagno di tempo nel lavoro.

Contiene:

- 30 rocchetti circa di tutti i modelli.

ROCCHETTINI

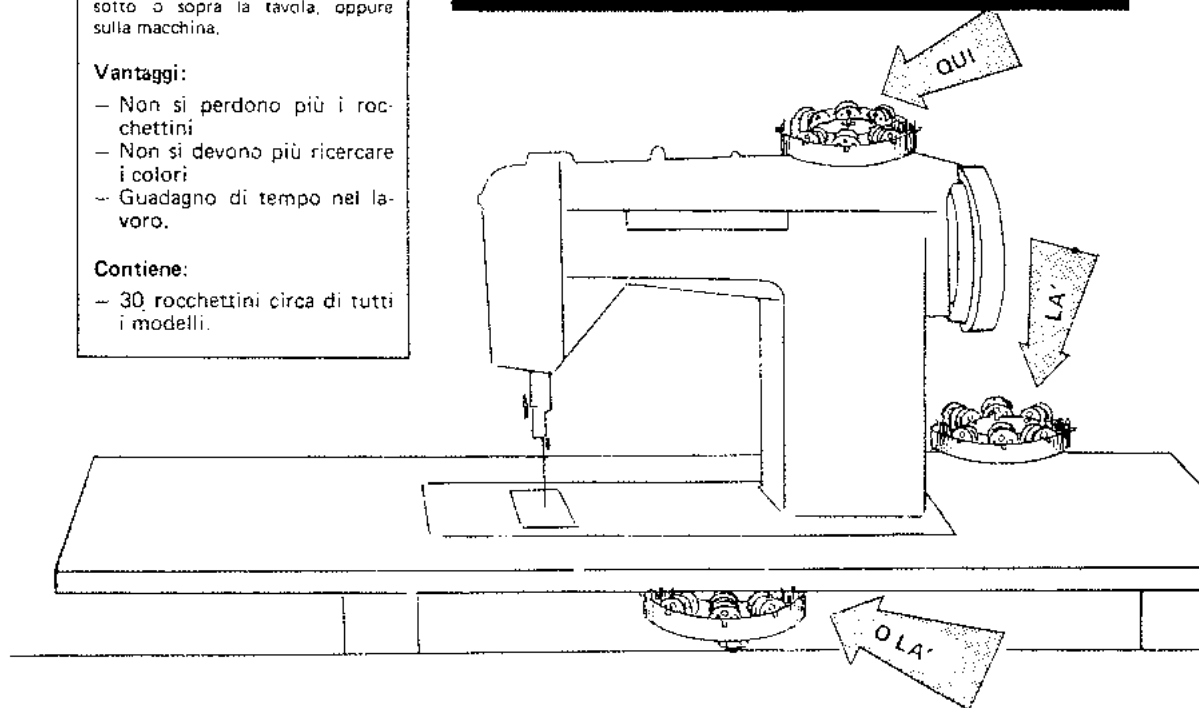

N. di catalogo
N. di descrizione

Descrizione

2083A

Portarocchetto

Ricambi

		PAG.
Sezione 4	Ricambi per Adler	119
Sezione 5	Ricambi per Brother	129
Sezione 6	Ricambi per Durkopp	131
Sezione 7	Ricambi per Juki	136
Sezione 8	Ricambi per Lewis - Kansai	147
Sezione 9	Ricambi per Mauser	157
Sezione 10	Ricambi per Merrow	164
Sezione 11	Ricambi per Necchi	165
Sezione 12	Ricambi per Pegasus	169
Sezione 13	Ricambi per Pfaff	177
Sezione 14	Ricambi per Reece	205
Sezione 15	Ricambi per Rimoldi	206
Sezione 16	Ricambi per Singer	211
Sezione 17	Ricambi per Siruba	217
Sezione 18	Ricambi per Union Special	219
Sezione 19	Ricambi per W. G.	228
Sezione 20	Ricambi per Yamato	234
Sezione 21	Crochet per macchine Blindstich e guide	251
Sezione 22	Affilatrici ed accessori	255
Sezione 23	Navette - Crochets	259
Sezione 24	Viti	275

Kl. 67

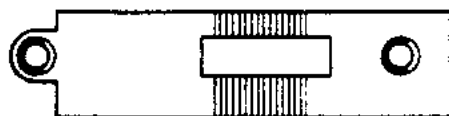

67200360



067210240



A067210250

067220720

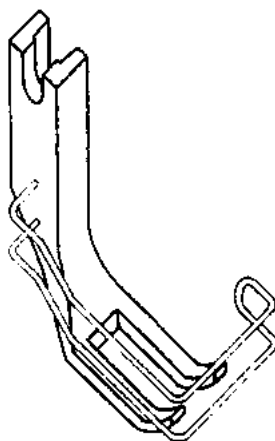

067220633



piastra vibrante completa
067241083



Kl. 68

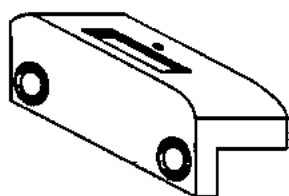

A 068 20002 0



A 068 21001 0

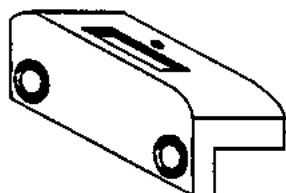

A 068 20003 0

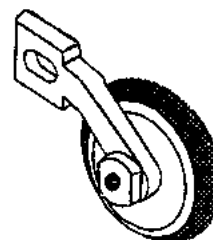

51155



068 21282 0 - 10 mm

068 21284 0 - 12 mm

N. di catalogo N. di descrizione	N. originale	Descrizione
A068200020	068200020	Placca ago foro medio
A068200030	068200030	Placca ago foro grande
A068210010	068210010	Griffa
51155	51155	Rotella a sfere
068512820	068512820	Griffa a due aghi - 10 mm
068512840	068512840	Griffa a due aghi - 12 mm

Kl. 69

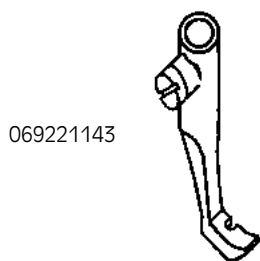

069221143



069221133

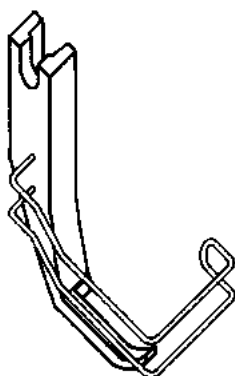

069221123

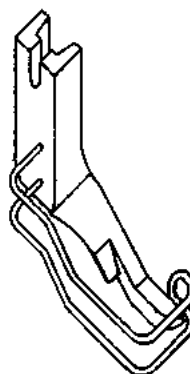

069221153

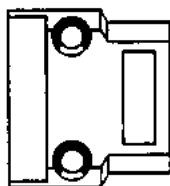

069001330



069002680



A069210180

N. di catalogo N. di descrizione	N. originale	Descrizione
069221143	069221143	Piedino anteriore D
069221123	069221123	Piedino posteriore D
069221133	069221133	Piedino anteriore S
069221153	069221153	Piedino posteriore S
069001330	069001330	Placca
069002680	069002680	Griffa
A069210180	069210180	Griffa

Kl. 69

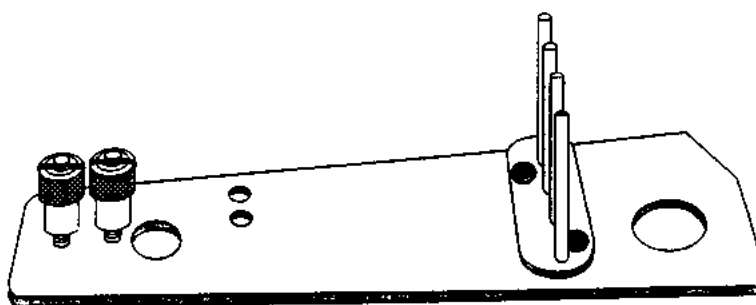
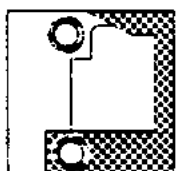
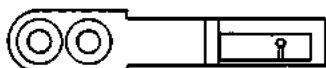
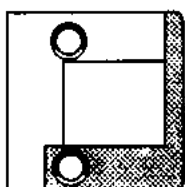
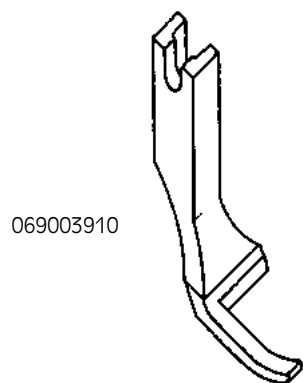

Kl. 167



167200070

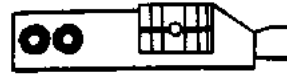

A167210100

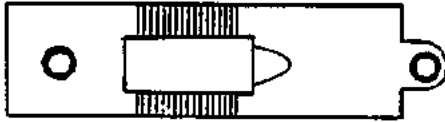

A167200150



A167210140

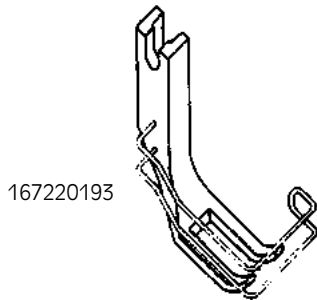

167220193

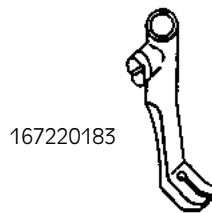

167220183

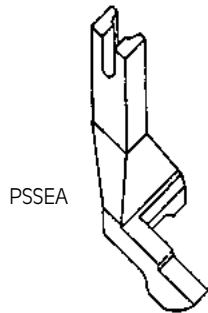

PSSEA

Piedini scanalati sagomati

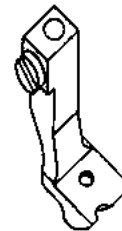

PSSIA

MISURE
3 mm
4 mm
5 mm
6 mm
7 mm

Piastra vibrante completa

067241083



Kl. 169



169240210

Kl. 467



467 20009 0
Placca agp mm. 8



467 21006 0
Griffa mm. 8

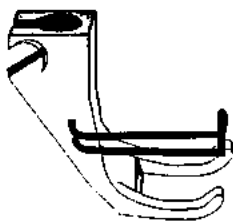

367 22099 3
Piedino posteriore



467 22001 3
Piedino anteriore

Trasformazione per bordare



367 20022 0
Placca per bordare



367 21016 0
Griffa per bordare

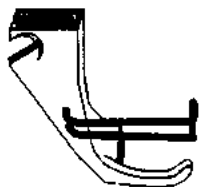

367 22050 3
Piedino posteriore



067 22080 3
Piedino anteriore

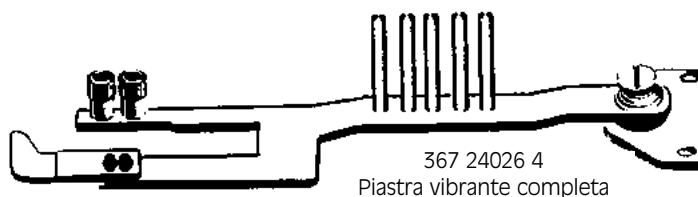

367 24026 4
Piastra vibrante completa

Kl. 67, 167, 267, 367, 467



3006 M
67460 *

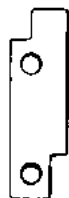

3007 M
67462 *



3008 M
067 33 057 0 *



3009 M
067 33 058 0 *



3010 M
067 33 070 0 *



3011 M
067 33 071 0



4501 M
367 33 1300 HSS



3012 M
067 35 122 0



3013 M
067 35 123 0



3021 M
067 93 60



3080 M
167 35 001 0



3072 M
167461*



3073 M
167462*

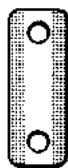

3075 M
167 33 002
con vicia



4502 M
367 21 0240 HSS



4503 M
367 33 0780 HSS

Kl. 296



3084 M
296 20 002 0*



3085 M
296 33 042 0*



3086 M
296 33 043 0*



3087 M
296 20 013 0
con vicia

Kl. 68

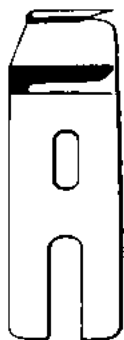

3026 M
68 460



3027 M
68 462

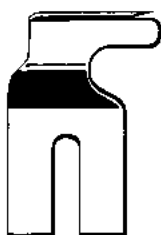

3028 M
68 668-3,1



3029 M
68 669 F/068 33 1190 0-2,7

Kl. 81



3041 M
81082*



3042 M
81066*



3043 M
83082*



3044 M
81582
con vicia



3045 M
83066 c*



3046 M
81223*



3047 M
81221*

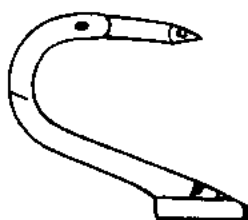

3051 M
81148

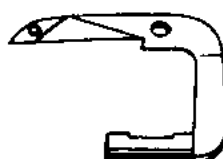

3052 M
81152

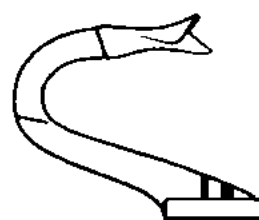

3053 M
81154

Kl. 381



3095 M
381 33 001 0*



3096 M
381 33 002 0*

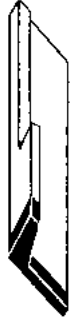

3097 M
381 33 033 0*
con vidia



3098 M
381 33 034 0*
con vidia



3099 M
381 33 041 0*

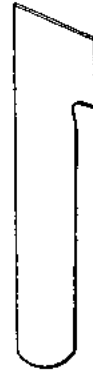

3100 M
381 33 042 0*

Kl. 369 Kv



3105 M
396 20 009 0*

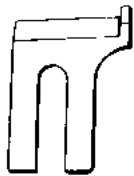

3106 M
396 33 069 0*



3107 M
396 33 070 0*



3102 M
396 350 750

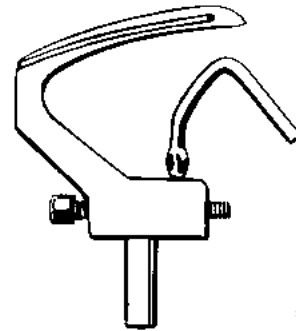

3945 M
077 15050

= SINGER 268369

Kl. 971

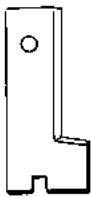

3112 M
971 44 014 0

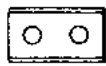

3113 M
971 44 018 0

Kl. 980

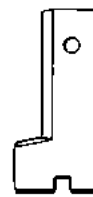

3118 M
980 44 061 0

Kl. 1296 = PFAFF

Kl. 568 = PFAFF

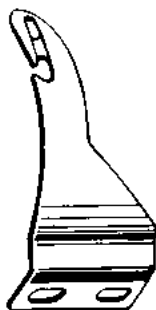

4505 M
91-175 540-05
129 350 010
129 350 020



3553 M
129 171 853



3519 M
568 33 0770
= 119 202 HSS



3520 M
568 33 0760
= 119 444 HSS

Kl. Everest



3125 M
10035/1 x *



3126 M
10035/2 x *



3127 M
10036/1 x *

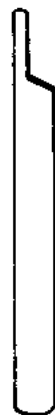

3128 M
10037/2 x *



3129 M
10038/2 x *

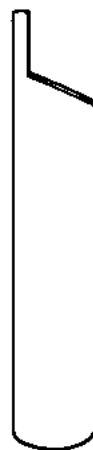

3130 M
10039/2 x *

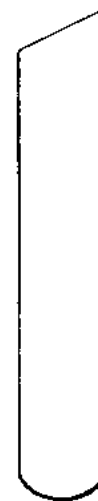

3131 M
10040/1 x *

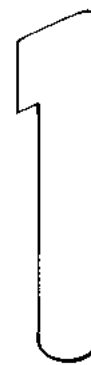

3132 M
10040/2 x *
(381330420)

ATTENZIONE: Il presente Catalogo non contempla tutti gli articoli disponibili in magazzino, ma è limitato a quelli di maggior consumo.

Si prega pertanto, per eventuali ordini di pezzi non illustrati, di indicare il loro numero originale e la classe della macchina, o inviare campioni.

Kl. B 511, B 531, B 551, B 561, B 571, B 581
 Kl. B 953, B 955, B 956, B 957, B 958, B 959
 Kl. B 972
 Kl. Super 600 = B 611, B 621, B 631, B 641, B 651, B 661
 B 671, B 681, B 691, B 672, B 682, B 692



4508 M
 140 567-001
 CT 140 567-001



3152 M
 140 568-001
 (CT)
 con vidia



3157 M
 142 198-001
 (CT)
 con vidia



3158 M
 142 242-001
 (CT)
 con vidia



4509 M
 148 815-001
 (CT)
 con vidia



3163 M
 144 074-001
 (CT)
 con vidia



3150 M
 118 527-001
 CT 118 527-001



3164 M
 144 007-001
 CT 144 077-001



3169 M
 112 376-001
 CT 112 376-001



3170 M
 112 436-001
 CT 112 436-001

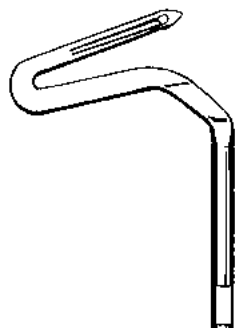

4513 M
 110 736-001

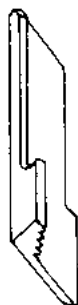

4510 M
 148 342-001
 scanalato



4514 M
 110 737-001



4511 M
 147 936-001
 146 792-001



4515 M
 147 934-001
 146 042-001
 146 612-001

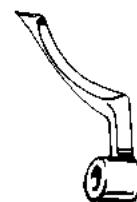

4516 M
 147 937-001
 146 962-001

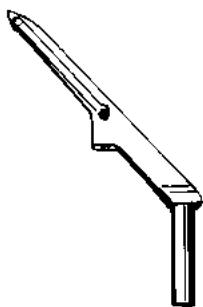

4517 M
 143 733-001

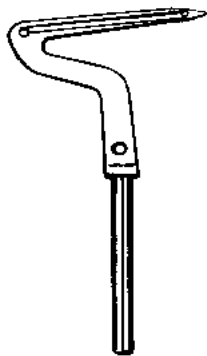

4518 M
 143 734-001

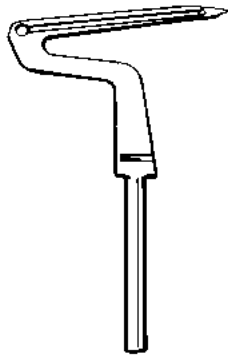

4519 M
 S 01 248-001
 144 049-001

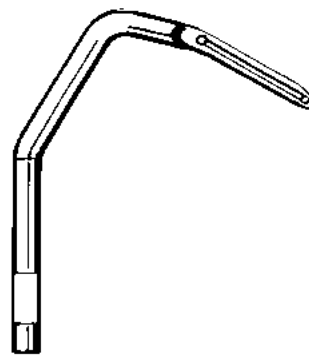

4520 M
 146 635-001

Kl. B 501, B 502, B 503,
B 504, B 505



3145 M
142 930
123 438-001



3146 M
142 858
123 439-001

Kl. DBZ B 755

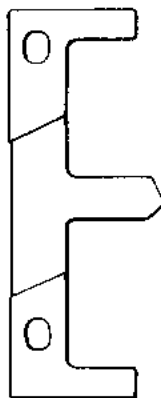

3147 M
142 061-0-01

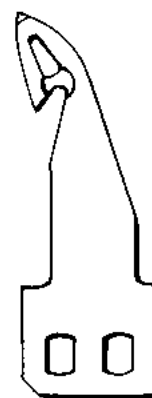

3148 M
142 058-0-00

Kl. 812
= Singer Kl. 71

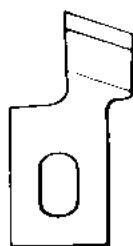

3175 M
mm 6-9

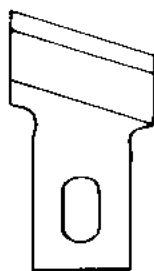

3176 M
mm 12-14-16
17-19

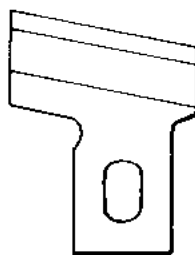

3177 M
mm 20-22-24-25

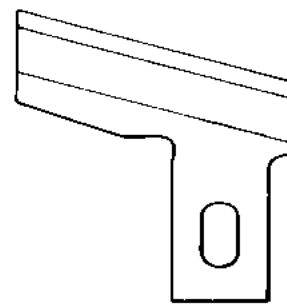

3178 M
mm 28-31

PER ASOLE

MOLTO IMPORTANTE

Questo Catalogo annulla tutte le precedenti edizioni.
Avendo apportato notevoli cambiamenti con aggiunte ed eliminazione di articoli, l'ordine numerico è così venuto spesso volte cambiato.
Preghiamo i Sigg. Clienti, nelle loro richieste, di voler sempre indicare oltre il numero e la descrizione dell'articolo, anche la relativa pagina di Catalogo.

Kl. 52

PER ASOLE

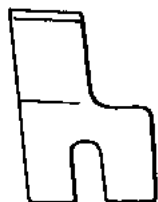

3191 M
mm 6-9

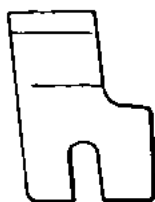

3192 M
mm 12-16-19

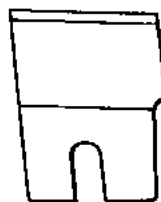

3193 M
mm 22-25



3194 M
mm 28-31

Kl. 211

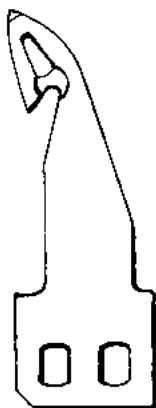

3205 M
219 6708

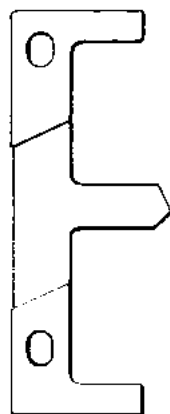

3207 M
211 9685

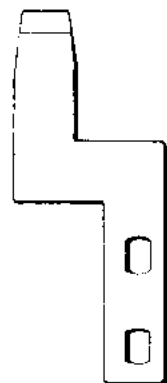

3206 M
211 50366

Kl. 212



3208 M
212 4931
con vicia

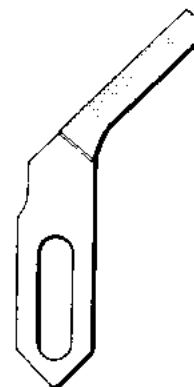

3209 M
212 11368
212 5058
con vicia

Kl. 238



3213 M
238 1418

Kl. 237



3210 M
204 1077*



3211 M
204 1076*



3212 M
204 1065*
Kl. 237-22 e 23

Kl. 551, 555, 556
= Singer Kl. 71

PER ASOLE



3175 M
mm 6-8-9-11

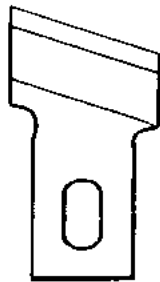

3176 M
mm 12-14-16
18-19

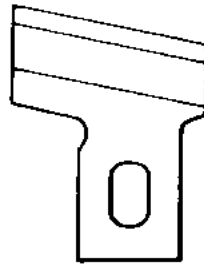

3177 M
mm 20-22-25

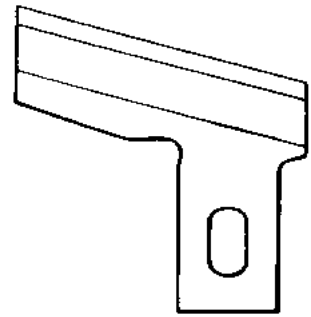

3178 M
mm 28-31

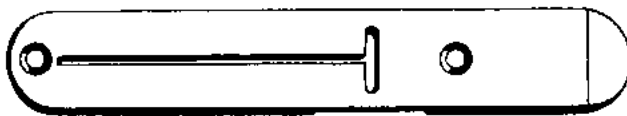

555 815

3243 M

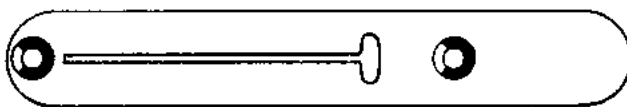

55 440

3244 M

Kl. 557



3251 M
557 287 2
(ex Nr. 557 605)



3252 M
557 602a

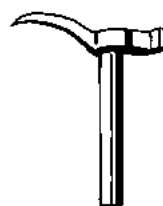

4528 M
557 611



4529 M
557 2876 K

AGO SCHMETZ SIST. 134R 5620

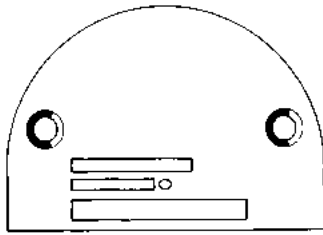

204243

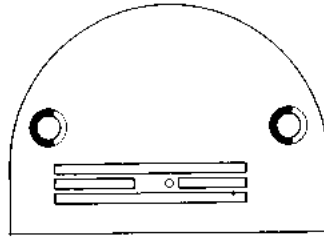

2114521

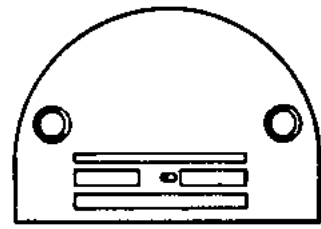

2111491

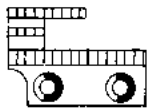

204268

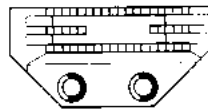

2114522

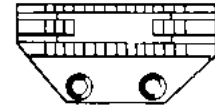

2111492

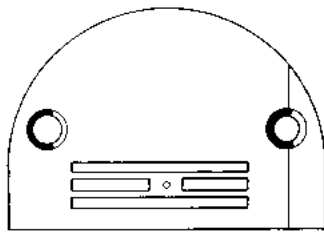

2119795

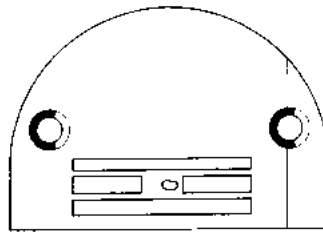

2119823

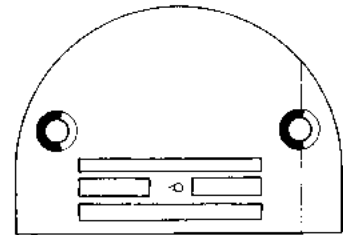

21150504 A

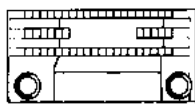

2119794

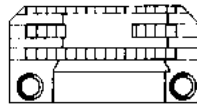

2119824

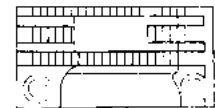

21150505 A

N. di catalogo N. di descrizione	N. Originale	Descrizione
204243	204243	Placca ago
204268	204268	Griffa
2114521	2114521	Placca ago
2114522	2114522	Griffa
2111491	2111491	Placca ago
2111492	2111492	Griffa
2119795	2119795	Placca ago rasafilo
2119794	2119794	Griffa rasafilo
2119823	2119823	Placca ago rasafilo
2119824	2119824	Griffa rasafilo
21150504 A	21150504 A	Placca ago rasafilo
21150505 A	21150505 A	Griffa rasafilo

AGO SCHMETZ SIST. 134R 134-35 135x1

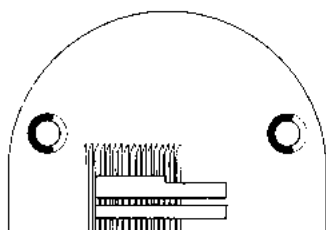

212875

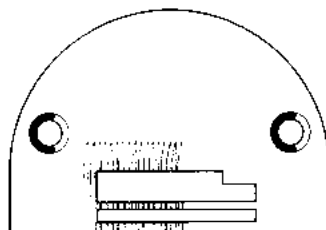

212901

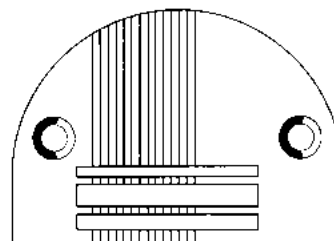

212V40046

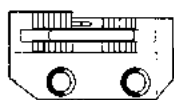

212876

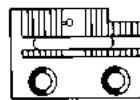

212869

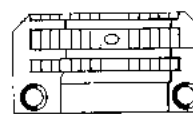

212V40048

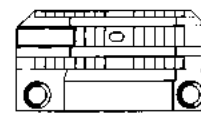

21252102

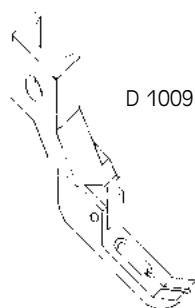

D 1009 A

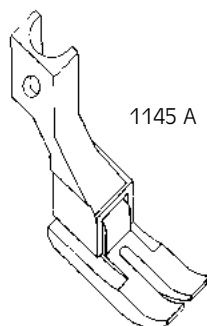

1145 A

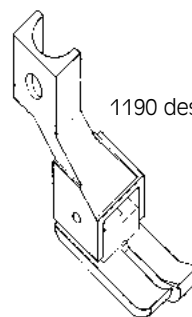

1190 destro

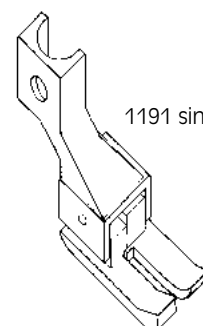

1191 sinistro

N. di catalogo N. di descrizione	N. Originale	Descrizione
212875	212875	Placca ago
212876	212876	Griffa
212901	212901	Placca ago
212869	212869	Griffa
212V40046	212V40046	Placca ago
212V40048	212V40048	Griffa
21252102	21252102	Griffa
D 1009 A		Piedino per cerniere
1145 A		Piedino suola teflon
1190 A 1/32		Piedino compensatore destro 1/32
1190 A 1/16		Piedino compensatore destro 1/16
1190 A 1/8		Piedino compensatore destro 1/8
1190 A 3/16		Piedino compensatore destro 3/16
1190 A 1/4		Piedino compensatore destro 1/4
1191 A 1/32		Piedino compensatore sinistro 1/32
1191 A 1/16		Piedino compensatore sinistro 1/16
1191 A 1/8		Piedino compensatore sinistro 1/8
1191 A 3/16		Piedino compensatore sinistro 3/16
1191 A 1/4		Piedino compensatore sinistro 1/4

AGO SCHMETZ SIST. 5620 134R

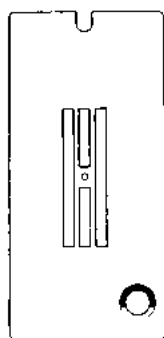

216931

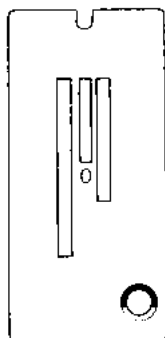

216932

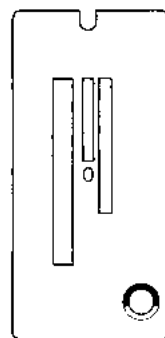

216946

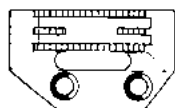

204260

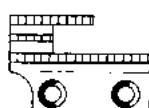

204956

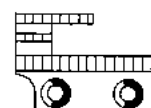

204268

N. di catalogo N. di descrizione	N. originale	Descrizione
216931	216931	Placca Durkopp 216
204260	204260	Griffa Durkopp 216
216932	216932	Placca Durkopp 216
204956	204956	Griffa Durkopp 216
216946	216946	Placca Durkopp 216
204268	204268	Griffa Durkopp 216

Kl. DLM 52, DLM 522

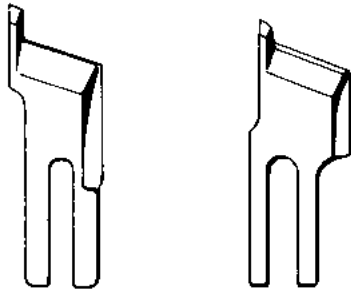

3261 M
B 4121-052-A00

4535 M
B 4121-522-000

Kl. MS 19, MS 26



3266 M
B 2515-026-F 001 1/4"

3267 M
B 2514-026-000 1/4"

3268 M
B 2513-026-F 00 1/4"

Kl. MO 102, 103, 104, 202, 204, 234 Bernette



4536 M
B 4108-352-00 B



4537 M
B 4108-352-00 D
(CT)
con vicia



4538 M
A 4113-102-000

**Kl. LBH 761—763, 771—773
= Singer Kl. 71**

PER ASOLE



3175 M
mm 6-9

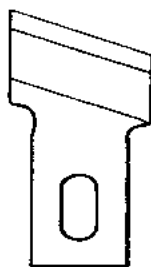

3176 M
mm 12-16-19

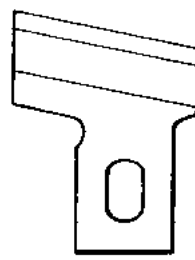

3177 M
mm 22-25

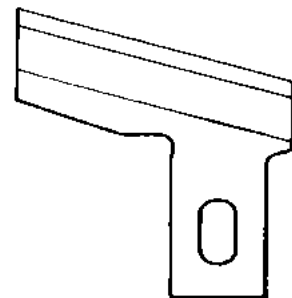

3178 M
mm 28-31

KI. MO 804, MP 816

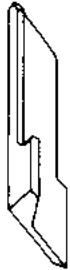

3281 M
B 4111-804-000

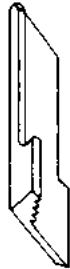

4545 M
B 4111-804-00D
scanalato



3282 M
B 4111-804-00A
(CT) con vicia



4546 M
B 4111-804-00E
(CT) con vicia



3283 M
B 4111-804-00C
(CT) con vicia

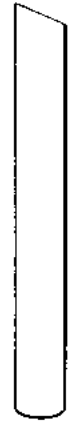

3284 M
B 4118-804-000
CT B 4118-804-000



3285 M
B 2519-804-000



4548 M
B 2519-804-00B



4549 M
B 2519-814-000

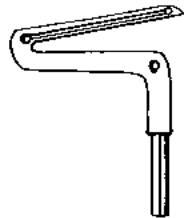

3286 M
B 2521-804-000

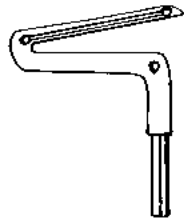

4550 M
B 2521-804-00B

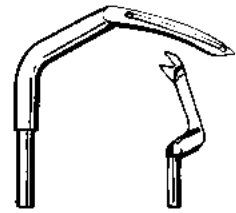

4551 M
B 2514-816-000



4552 M
B 2514-803-000

**KI. MO 2304, MO 2314, MO 2316
MO 2404, MO 2414, MO 2416
MO 2504, MO 2514, MO 2516**



4553 M
118-45 906



4554 M
CT 118-45 906
con vicia



4555 M
118-45 807

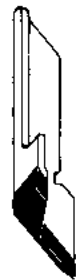

4556 M
CT 118-45 807
con vicia



4557 M
118-45 609
(CT) con vicia

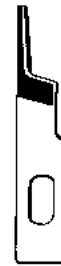

4558 M
118-45 708
(CT) con vicia



4559 M
118-46 003



4560 M
118-88 005

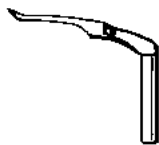

4561 M
118-88 104

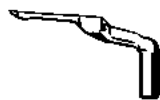

4562 M
118-88 302

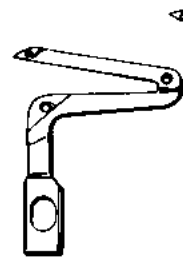

4563 M
118-88 401

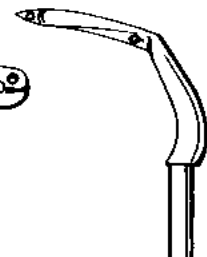

4564 M
118-29 405

KI. MO 352, 357

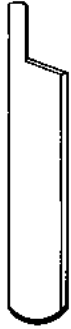

3275 M
B 4108-352-00B
CT = B 4108-352-00D



3276 M
B 4122-352-00A

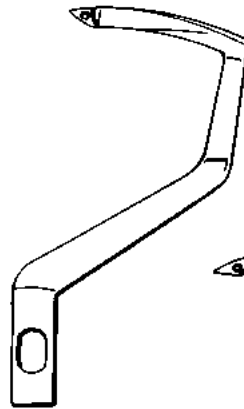

4567 M
B 2011-357-000

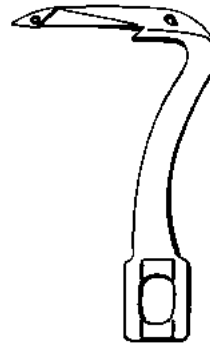

4568 M
B 2521-352-000

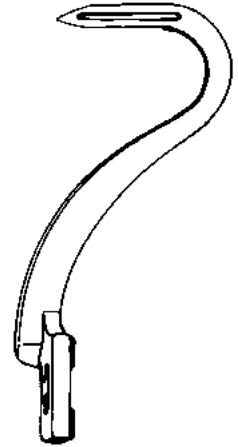

4569 M
B 2520-352-000

KI. DDL 555, DLN 415



4570 M
D 2402-555-BA0



4571 M
D 2402-555-BAB



4572 M
D 2402-415-BA0

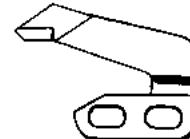

4573 M
D 2406-555-B00

KI. Babylock EF 205, 605, 406, 434, 436



3295 M
305 149
CT 305 149



3296 M
305 248
405-9102-01A

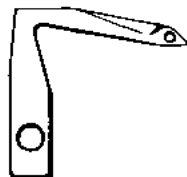

4574 M
605-6102-01 A



4575 M
PL-Q11-01A



4576 M
PL-Q11-01A



4577 M
PL-Q11-01C



4578 M
SE-R11-01A

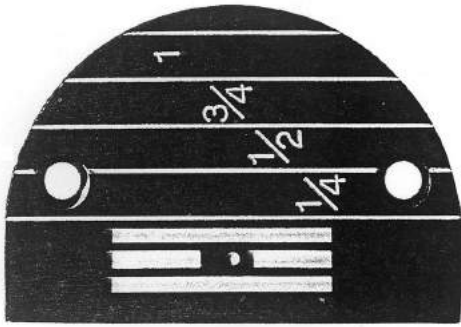

B 1109-552-000

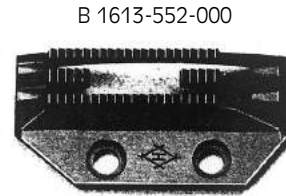

B 1613-552-000

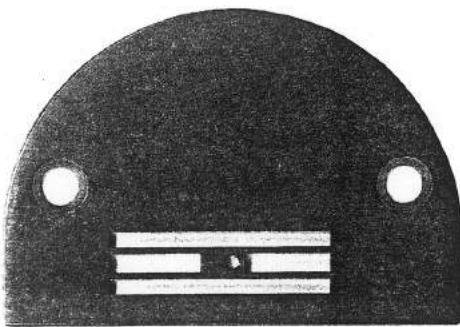

B 1109-012-100

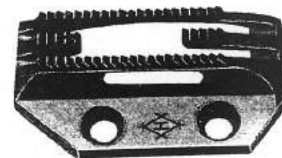

B 1613-012-100

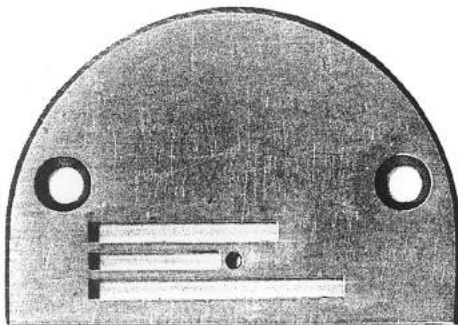

B 1109-012-A00 (B 1190-012-000)

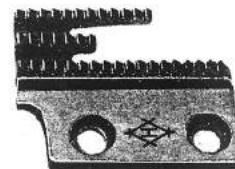

B 1613-012-OA0

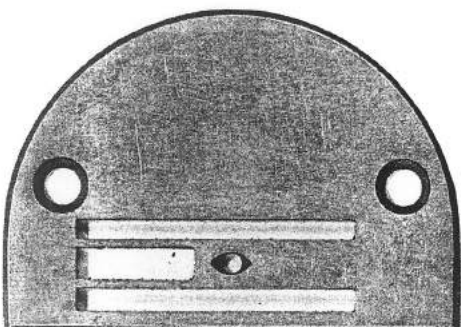

B 1109-555-H0B

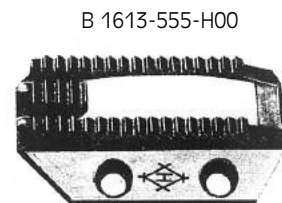

B 1613-555-H00

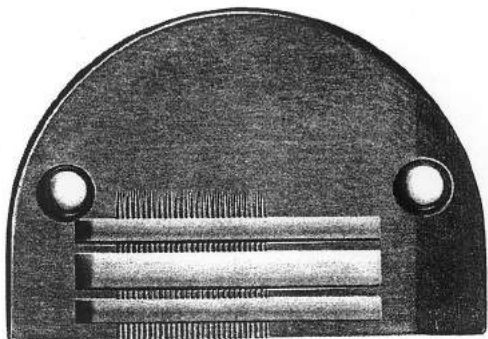

B 1109-415-H0B

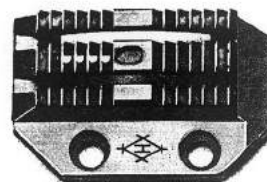

B 1609-415-H00



D 3128-555-D00

B 3128-012-000



D 3129-555-D00

B 3114-232-000

B 3129-012-A00

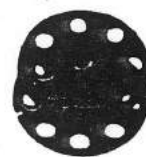

270010

B 9117-012-000

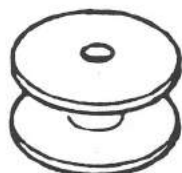

B 9117-552-A00

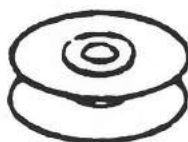

B 1811-771-000

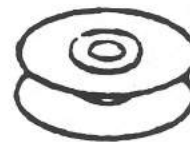

B 1809-761-000



E4554M
CT 118-45 906



E4556M
CT 118-45 807



E4559M
118-46 003



E4558M
118-45 708
(CT)



E4557M
118-45 609
(CT)

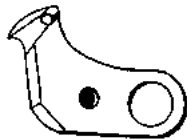

110-40052

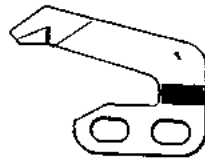

D 2406-555-DOH



B-1528-804-000A



E4560M
118-88 005

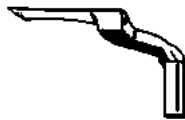

119-99 208

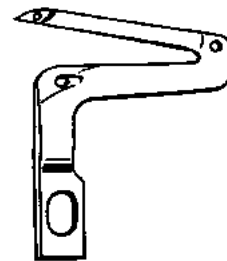

119-99 307

KI. LBH 761—763, 771—773, 781—784, LBH 793
= Singer KI. 71

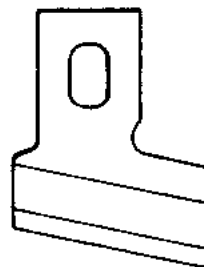
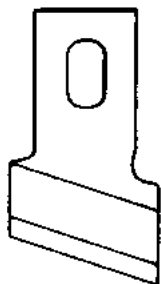
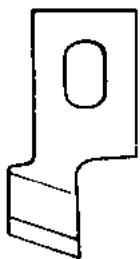

- E3175M6** B 2702-047-F00 1/4"
- E3175M9** B 2702-047-K00 3/8"
- E3175M12** B 2702-047-L00 1/2"
- E3175M14** B 2702-047-V00 9/16"
- E3175M16** B 2702-047-M00 5/8"
- E3175M19** B 2702-047-N00 3/4"
- E3175M22** B 2702-047-P00 7/8"
- E3175M25** B 2702-047-Q00 1"

KI. MO 812/DD6, DF6

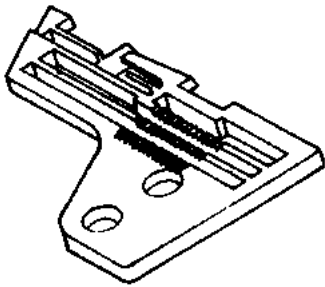

R4308 EOF E00

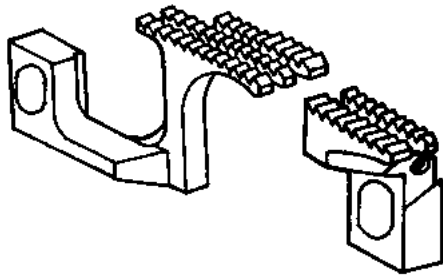

B1657 812 DOA



B1656 812 D0C



B1658 804 000

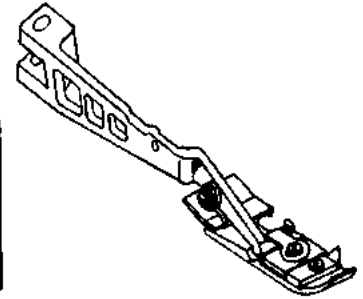

B1507 812 DAC

KI. MO 814/BD4

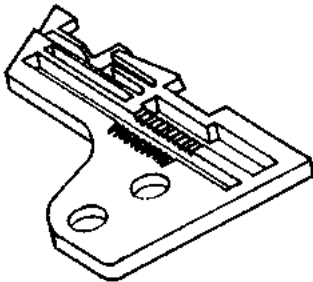

R4205 EOD E00

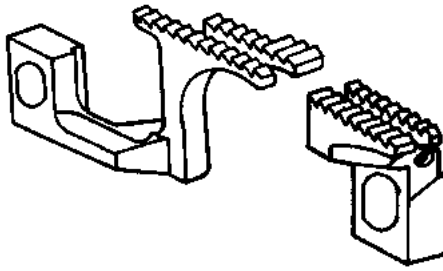

B1657 804 00C



B1656 804 000



B1658 804 000

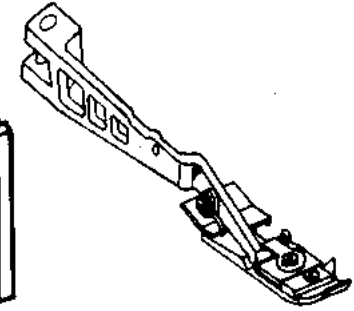

B1507 814 0A0

KI. MO 816/DD4

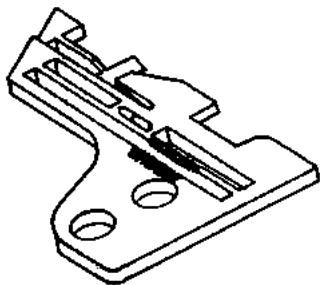

R4508 EOD C00

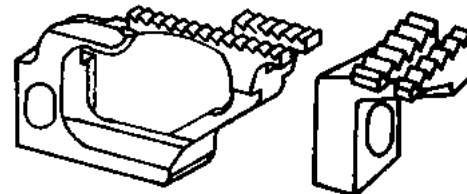

B1657 816 000

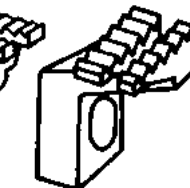

B1656 816 000



B1658 804 000

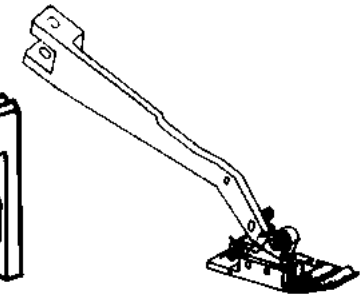

B1507 816 0A0

KI. MO 816/FF6

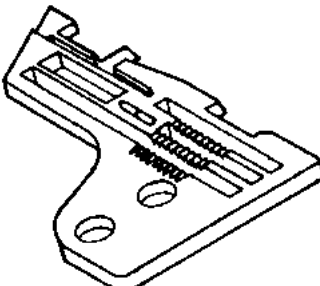

R4612 EOF G00A

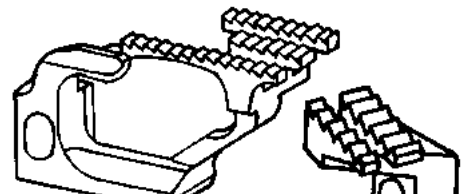

B1657 816 FOK

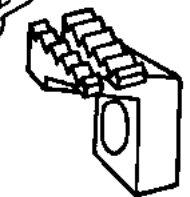

B1656 816 FOH



B1658 804 000

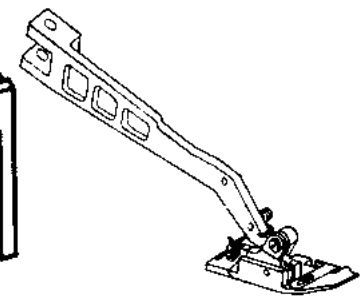

B1507 816 FAD

KI. MO 804/OD4

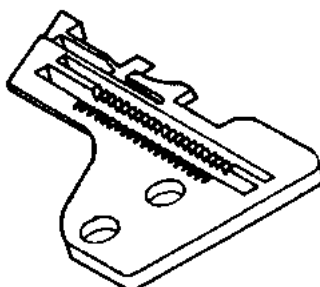

R4200 EOD C00

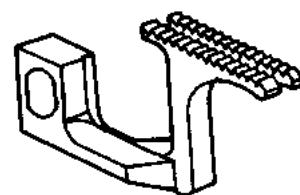

B1657 805 000A

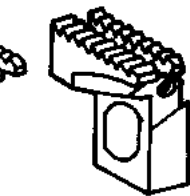

B1656 805 000



B1658 804 000

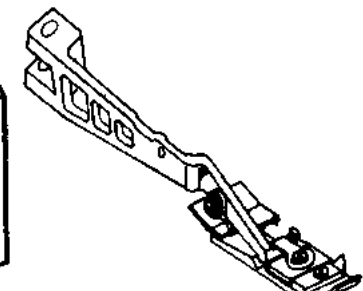

B1507 804 0A0

KI. MO-2400; MQ-2500

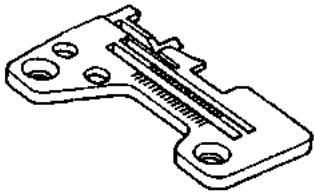

R-4200-HOD-DAO

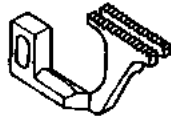

B-1657 804 00T



118-82107



118-87106

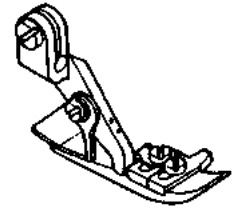

118-81455
(MO-2504-0D4-200)

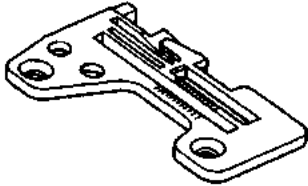

R-4205-HOD-EAO

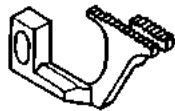

B-1657-814-BOE



115-97101



118-87106

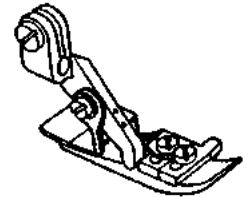

118-81554
(MO-2514-BD4-200)

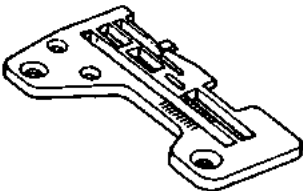

R-4508-HOD-DAO



118-85209



118-82800



118-87403

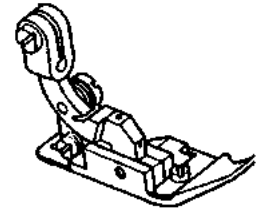

118-77552
(MO-2516)

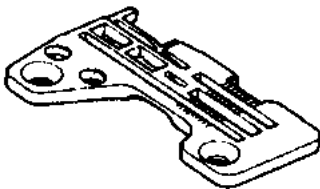

R-4612-HOF-G00

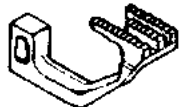

118-85407



118-83006



118-87403



118-77750
(MO-2414-FF6-500)
(MO-2415-FF6-500)

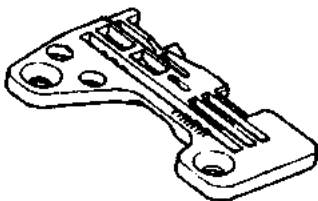

R-4608-HOD-F00



118-85308



118-82909



118-87403

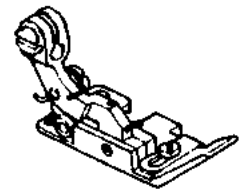

118-77651
(MO-2416-DF6/DH6-500)
(MO-2516-DF6/DH6-500)

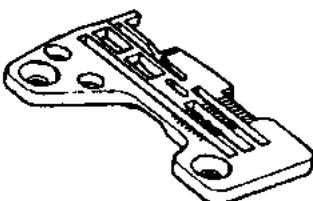

R-4608-HOF-G00

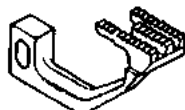

118-85407



118-84400



118-87403

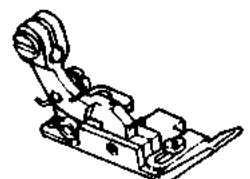

118-77651
(MO-2416-DF6/DH6-500)
(MO-2516-DF6/DH6-500)

KI. MO-2400; MQ-2500

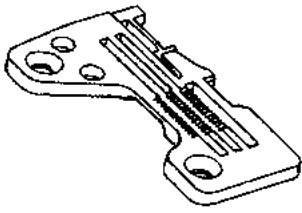

R-4300-HOD-E00

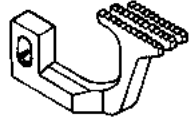

118-85100



118-82206



118-87106

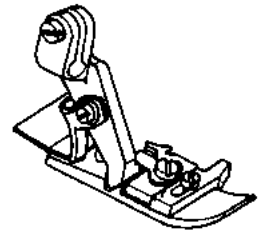

118-76364 (OD6)

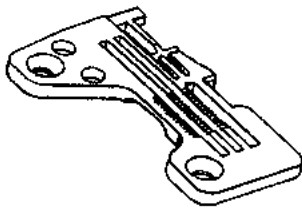

R-4305-HOD-E00

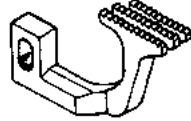

118-86504



118-82404



118-87106

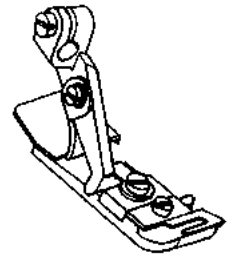

118-76869

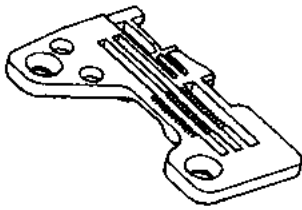

R-4308-HOF-E00

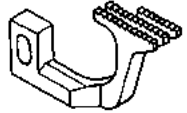

117-90706



118-82503



118-87205

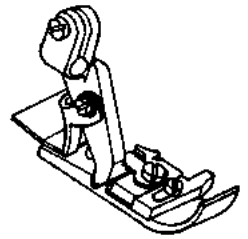

118-77156

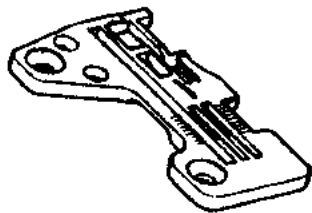

R-4608-HOD-E01

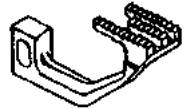

118-86009



118-82305



118-87403



118-77966

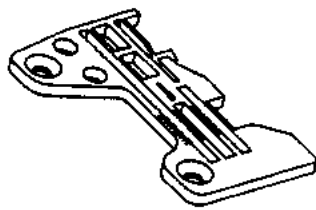

R-4612-HOD-E01

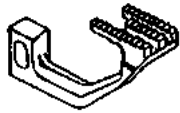

118-86009

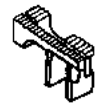

118-84004



118-87403

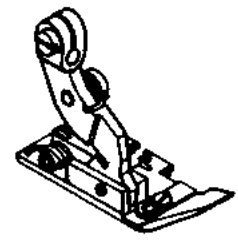

118-78063

KI. MO-2400; MQ-2500

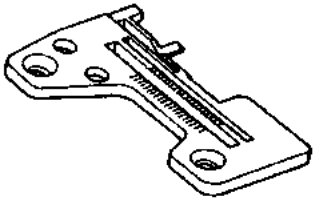

R-4200-HOD-DAB

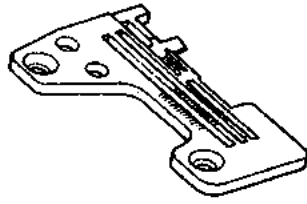

R-4305-HOD-EAB

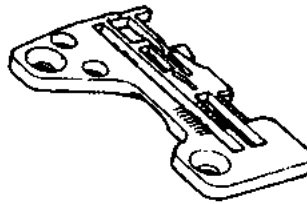

R-4505-HOD-D00

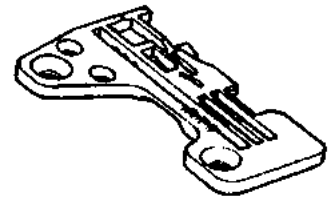

R-4605-HOD-F00

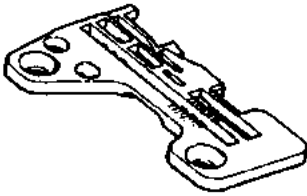

R-4508-HOD-B00

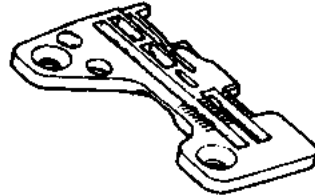

R-4508-HOE-D00

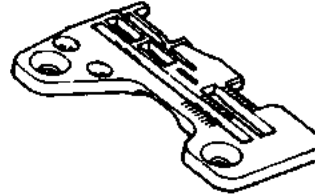

R-4508-HOF-D00

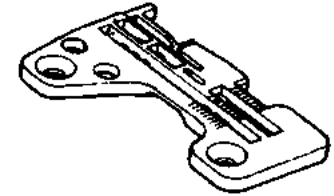

R-4508-HOG-D00

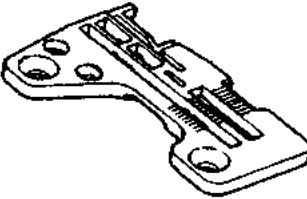

R-4508-HOH-D00



118-82602



118-87304

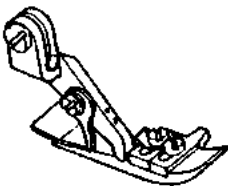

118-76158

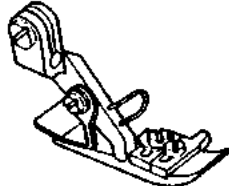

118-81471



118-76166

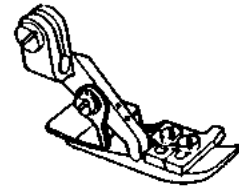

118-76851

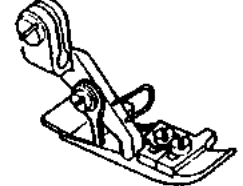

118-81570

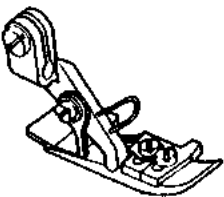

118-76869

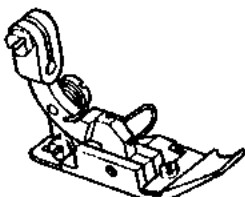

118-77578

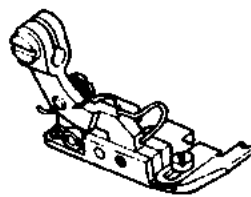

118-77362

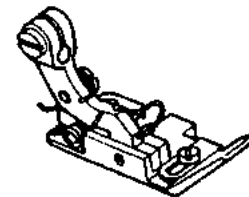

118-77768

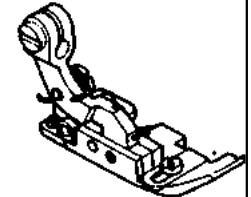

118-77255

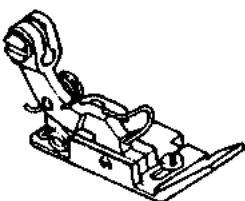

118-77669

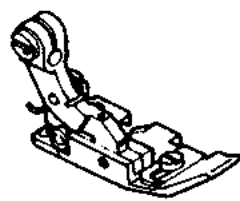

118-78055



118-78766

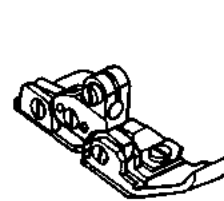

118-80762



118-78550
(117-78568)



Vite leva 5550
B 1521 555 000



Vite mov.col.5550
SD-0460702-TP



Vite coltello 555
SD-0500095-TH



Vite coltello 373
SD-0600095-TH



Vite mov.col.5550
SD-0630275-SP



Vite TC
SD-0720801-TH



Vite coltello 555
SS-2060210-SP



Vite placca 2500
SS-2110710-TP



Vite placca 3900
SS 2110910 SL



Vite placca 5550
SS-2110915-SP



Vite placca 555
SS-2110920-TP



Vite griffa TC
SS-4080610-SP



Vite griffa 555
SS-4080620-TP



Vite passafilo 3900
SS4090615-SP



Vite
SS4110715-SP



Vite 5550
SS-4111015-SP



Vite
SS-4120915-SP



Vite
SS-5060310-SP



Vite col.cat. 800
SS-5060410-SP



Vite lam. pied. TC
SS-6060210-SP



Vite passafilo TC
SS-6080410-SP



Vite
SS-6090510-SP



Vite croc.inf. TC
SS-6090620-SP



Vite piedino TC
SS-6090650-SP



Vite passafilo TC
SS-6090670-TP



Vite
SS-6110610-TP



Vite TC
SS-6110710-TP



Vite crochet 555
SS-6111010-SP



Vite TC
SS-6111040-SP



SS-6120930-TP



Vite TC
SS-6661110-SP



Vite salva ago 800
SS-7060610-SP



Vite coltello 373
SS-7080310-SP



Vite ago 555
SS-7080510-TP



Vite salva ago 3900
SS-7090510-SP



Vite passafilo TC
SS-7090530-SP



SS-7090540-SP



salva ago 2500
SS-7090610-SP



Vite
SS-7090850-SP



Vite piedino 555
SS-7091110-SP



Vite
SS-7110510-SP



Vite salvo
SS-7110710-SP



SS-7110740-TP



Vite Passafilo TC
SS-7110840SP



Vite
SS-7111120-SP



Vite
SS-7111410-SP



Vite
SS-7121410-SP



Vite leva TC
SS-7161040-SP



SS-7681650-SP



Vite ago TC
SS-8080310-TP



Vite crochet 800
SS-8090410-SP



SS-8090670-SP



Grano
SS-8110410-TP



Grano mor. Ago 2500
SS-8110422-TP



SS-8150710-TP



Grano
SS-8151150-SP



SS 8151570-SP



Grano
SS-8660610-TP



SS-8660810-TP



SS- 8681650-TP



Vite
SS-9090410-TP



Vite
SS-9090610-TP



Vite col. sup. 3700
SS-9090813-TP



Vite griffa 800
SS-9111010-TP



Vite col. inf. 800
SS-9111013-SP



Vite graffa TC
SS-9111 050-SP



Vite col. sup. 2500 N.
SS-91 11610-SP



Vite col. sup. 2700 E.
SS-9112310-SP



Vite piastra 373
SS-9120643-TP



Vite biella TC
SS-9151210-TP

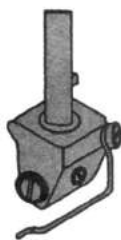

12-8020-1
Morsetto ago

	mm	Codice N.	
3/16"	4.76	12-8130-1	2 Aghi
7/32"	5.56	12-8140-1	
1/4"	6.35	12-8150-1	
7/32"	5.56	12-8010-1	3 Aghi
1/4"	6.35	12-8020-1	

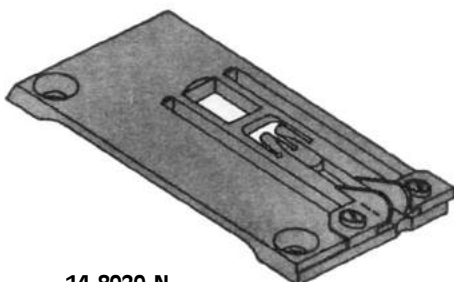

14-8020-N
Placca ago

	mm	Codice N.	
3/16"	4.76	14-8030-N	2 Aghi
7/32"	5.56	14-8040-N	
1/4"	6.35	14-8050-N	
7/32"	5.56	14-8010-N	3 Aghi
1/4"	6.35	14-8020-N	

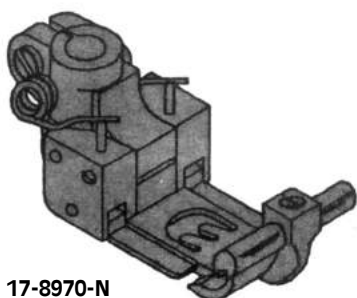

17-8970-N
Piedino

	mm	Codice N.	
3/16"	4.76	17-8470-N	2 Aghi
7/32"	5.56	17-8570-N	
1/4"	6.35	17-8670-N	
7/32"	5.56	17-8870-N	3 Aghi
1/4"	6.35	17-8970-N	

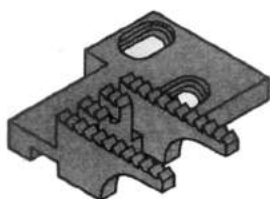

15-7310-0
Griffa posteriore

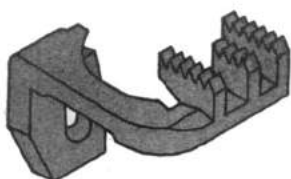

15-7610-0
Griffa anteriore

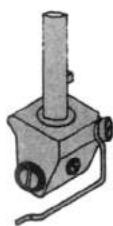

12-8020-1
Morsetto ago

mm		Codice N.	2 Aghi
1/8"	3.17	12-8110-1	
5/32"	3.97	12-8120-1	
3/16"	4.76	12-8130-1	
7/32"	5.56	12-8140-1	
1/4"	6.35	12-8150-1	
7/32"	5.56	12-8010-1	3 Aghi
1/4"	6.35	12-8020-1	

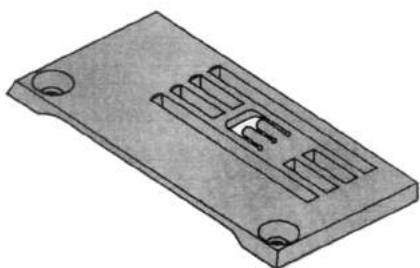

14-8640-0
Placca ago

mm		Codice N.	2 Aghi
1/8"	3.17	14-7240-0	
5/32"	3.97	14-7340-0	
3/16"	4.76	14-7440-0	
7/32"	5.56	14-7540-0	
1/4"	6.35	14-7640-0	
7/32"	5.56	14-8540-0	3 Aghi
1/4"	6.35	14-8640-0	

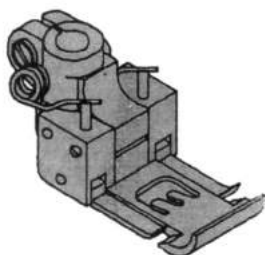

17-8940-1
Piedino

mm		Codice N.
1/8"	3.17	17-8240-1
5/32"	3.97	17-8340-1
3/16"	4.76	17-8440-1
7/32"	5.56	17-8540-1
1/4"	6.35	17-8640-1
* 7/32"	5.56	17-8840-1
* 1/4"	6.35	17-8940-1

* 3 Aghi

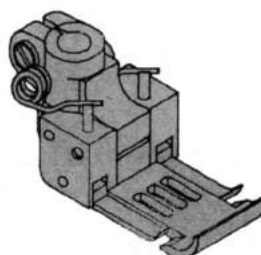

17-7940-1
Piedino

mm		Codice N.
1/8"	3.17	17-7240-1
5/32"	3.97	17-7340-1
3/16"	4.76	17-7440-1
7/32"	5.56	17-7540-1
1/4"	6.35	17-7640-1
* 7/32"	5.56	17-7840-1
* 1/4"	6.35	17-7940-1

* 3 Aghi

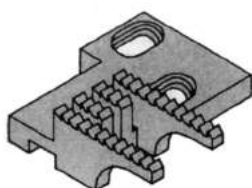

15-7530-0
Griffa posteriore

mm		Codice N.	2 Aghi
1/8"	3.17	15-7550-0	
5/32"	3.97	15-7550-0	
3/16"	4.76	15-7530-0	
7/32"	5.56	15-7530-0	
1/4"	6.35	15-7530-0	
7/32"	5.56	15-7530-0	3 Aghi
1/4"	6.35	15-7530-0	

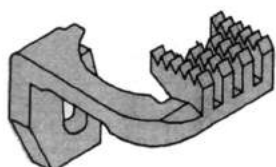

15-7230-0
Griffa anteriore

mm		Codice N.	2 Aghi
1/8"	3.17	15-7240-0	
5/32"	3.97	15-7240-0	
3/16"	4.76	15-7230-0	
7/32"	5.56	15-7230-0	
1/4"	6.35	15-7230-0	
7/32"	5.56	15-7230-0	3 Aghi
1/4"	6.35	15-7230-0	

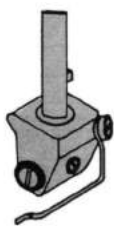

12-8020-1
Morsetto ago

mm		Codice N.	2 Aghi
1/8"	3.17	12-8110-1	
5/32"	3.97	12-8120-1	
3/16"	4.76	12-8130-1	
7/32"	5.56	12-8140-1	
1/4"	6.35	12-8150-1	
7/32"	5.56	12-8010-1	3 Aghi
1/4"	6.35	12-8020-1	

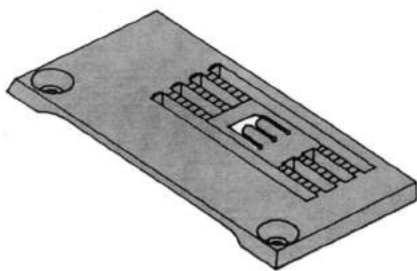

14-8650-0
Placca ago

mm		Codice N.	2 Aghi
1/8"	3.17	14-7250-0	
5/32"	3.97	14-7350-0	
3/16"	4.76	14-7450-0	
7/32"	5.56	14-7550-0	
1/4"	6.35	14-7650-0	
7/32"	5.56	14-8550-0	3 Aghi
1/4"	6.35	14-8650-0	

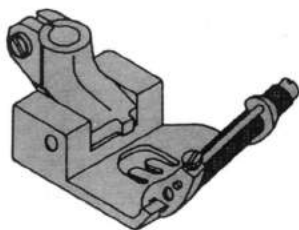

17-8950-1
Piedino

mm		Codice N.
1/8"	3.17	17-8250-1
5/32"	3.97	17-8350-1
3/16"	4.76	17-8450-1
7/32"	5.56	17-8550-1
1/4"	6.35	17-8650-1
* 7/32"	5.56	17-8850-1
* 1/4"	6.35	17-8950-1

* 3 Aghi

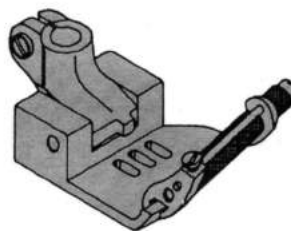

17-7950-1
Piedino

mm		Codice N.
1/8"	3.17	17-7250-1
5/32"	3.97	17-7350-1
3/16"	4.76	17-7450-1
7/32"	5.56	17-7550-1
1/4"	6.35	17-7650-1
* 7/32"	5.56	17-7850-1
* 1/4"	6.35	17-7950-1

* 3 Aghi

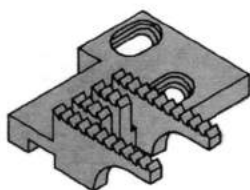

15-7530-0
Griffa posteriore

mm		Codice N.	2 Aghi
1/8"	3.17	15-7550-0	
5/32"	3.97	15-7550-0	
3/16"	4.76	15-7530-0	
7/32"	5.56	15-7530-0	
1/4"	6.35	15-7530-0	
7/32"	5.56	15-7530-0	3 Aghi
1/4"	6.35	15-7530-0	

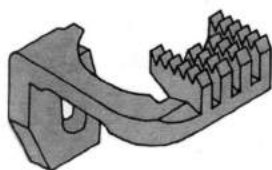

15-7230-0
Griffa anteriore

mm		Codice N.	2 Aghi
1/8"	3.17	15-7240-0	
5/32"	3.97	15-7240-0	
3/16"	4.76	15-7230-0	
7/32"	5.56	15-7230-0	
1/4"	6.35	15-7230-0	
7/32"	5.56	15-7230-0	3 Aghi
1/4"	6.35	15-7230-0	

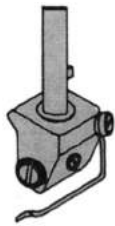

12-8020-1
Morsetto ago

	mm	Codice N.	
1/8"	3.17	12-8110-1	2 Aghi
5/32"	3.97	12-8120-1	
3/16"	4.76	12-8130-1	
7/32"	5.56	12-8140-1	
1/4"	6.35	12-8150-1	3 Aghi
7/32"	5.56	12-8010-1	
1/4"	6.35	12-8020-1	

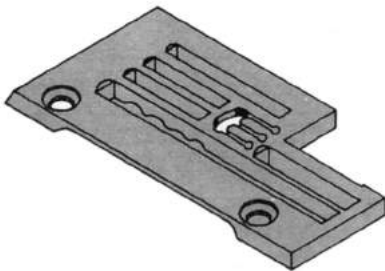

14-8680-0
Placca ago

	mm	Codice N.	
1/8"	3.17	14-7280-0	2 Aghi
5/32"	3.97	14-7380-0	
3/16"	4.76	14-7480-0	
7/32"	5.56	14-7580-0	
1/4"	6.35	14-7680-0	3 Aghi
7/32"	5.56	14-8580-0	
1/4"	6.35	14-8680-0	

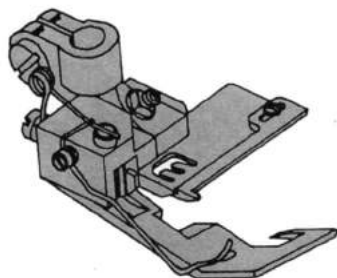

17-8990-1
Placca ago

	mm	Codice N.	
1/8"	3.17	17-8290-1	2 Aghi
5/32"	3.97	17-8390-1	
3/16"	4.76	17-8490-1	
7/32"	5.56	17-8590-1	
1/4"	6.35	17-8690-1	3 Aghi
7/32"	5.56	17-8890-1	
1/4"	6.35	17-8990-1	

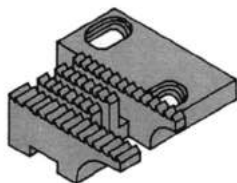

15-8280-0
Griffa posteriore

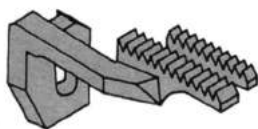

15-7280-0
Griffa anteriore

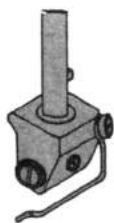

12-8020-1
Morsetto ago

	mm	Codice N.	
1/8"	3.17	12-8110-1	2 Aghi
5/32"	3.97	12-8120-1	
3/16"	4.76	12-8130-1	
7/32"	5.56	12-8140-1	
1/4"	6.35	12-8150-1	3 Aghi
7/32"	5.56	12-8010-1	
1/4"	6.35	12-8020-1	

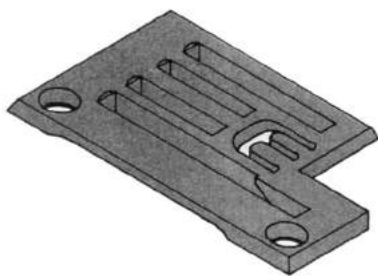

14-8660-0
Placca ago

	mm	Codice N.	
1/8"	3.17	14-7260-0	2 Aghi
5/32"	3.97	14-7360-0	
3/16"	4.76	14-7460-0	
7/32"	5.56	14-7560-0	
1/4"	6.35	14-7660-0	3 Aghi
7/32"	5.56	14-8560-0	
1/4"	6.35	14-8660-0	

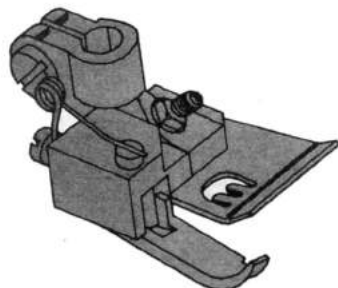

17-8960-1
Placca ago

	mm	Codice N.	
1/8"	3.17	17-8260-1	2 Aghi
5/32"	3.97	17-8360-1	
3/16"	4.76	17-8460-1	
7/32"	5.56	17-8560-1	
1/4"	6.35	17-8660-1	3 Aghi
7/32"	5.56	17-8860-1	
1/4"	6.35	17-8960-1	

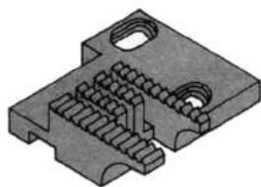

15-7560-0
Griffa posteriore

	mm	Codice N.	
1/8"	3.17	15-7580-0	2 Aghi
5/32"	3.97	15-7580-0	
3/16"	4.76	15-7560-0	
7/32"	5.56	15-7560-0	
1/4"	6.35	15-7560-0	3 Aghi
7/32"	5.56	15-7560-0	
1/4"	6.35	15-7560-0	

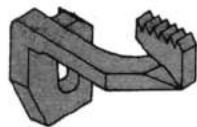

15-7270-0
Griffa anteriore

	mm	Codice N.	
1/8"	3.17	15-7290-0	2 Aghi
5/32"	3.97	15-7290-0	
3/16"	4.76	15-7270-0	
7/32"	5.56	15-7270-0	
1/4"	6.35	15-7270-0	3 Aghi
7/32"	5.56	15-7270-0	
1/4"	6.35	15-7270-0	

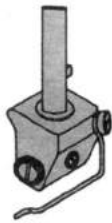

12-8020-1
Morsetto ago

	mm	Codice N.	3 Aghi
7/32"	5.56	12-8010-1	
1/4"	6.35	12-8020-1	

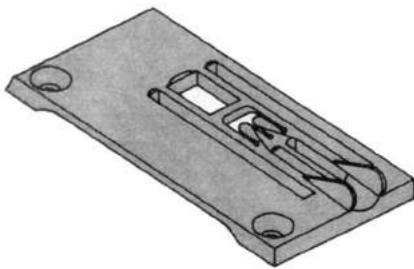

14-8640-C
Placca ago

	mm	Codice N.	3 Aghi
7/32"	5.56	14-8540-C	
1/4"	6.35	14-8640-C	

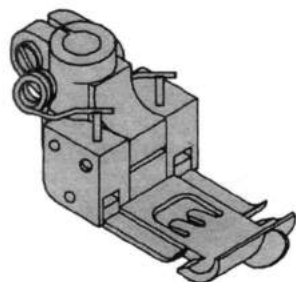

17-8970-1
Piedino

	mm	Codice N.	3 Aghi
7/32"	5.56	17-8870-1	
1/4"	6.35	17-8970-1	

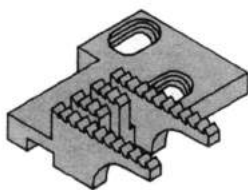

15-7530-0
Griffa posteriore

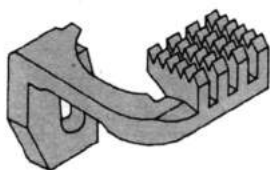

15-7230-0
Griffa anteriore

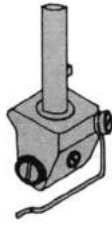

12-8020-1
Morsetto ago

mm		Codice N.	2 Aghi
1/8"	3.17	12-8110-1	
5/32"	3.97	12-8120-1	
3/16"	4.76	12-8130-1	
7/32"	5.56	12-8140-1	
1/4"	6.35	12-8150-1	
7/32"	5.56	12-8010-1	3 Aghi
1/4"	6.35	12-8020-1	

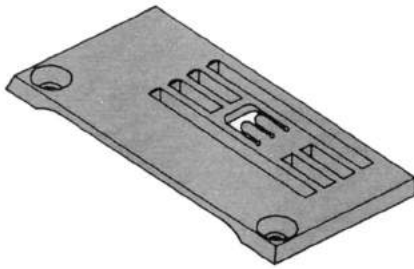

14-8640-0
Placca ago

mm		Codice N.	2 Aghi
1/8"	3.17	14-7240-0	
5/32"	3.97	14-7340-0	
3/16"	4.76	14-7440-0	
7/32"	5.56	14-7540-0	
1/4"	6.35	14-7640-0	
7/32"	5.56	14-8540-0	3 Aghi
1/4"	6.35	14-8640-0	

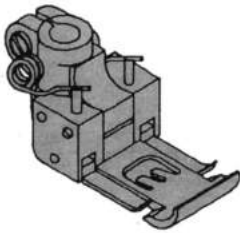

17-8940-1
Piedino

mm		Codice N.
1/8"	3.17	17-8240-1
5/32"	3.97	17-8340-1
3/16"	4.76	17-8440-1
7/32"	5.56	17-8540-1
1/4"	6.35	17-8640-1
* 7/32"	5.56	17-8840-1
* 1/4"	6.35	17-8940-1

* 3 Aghi

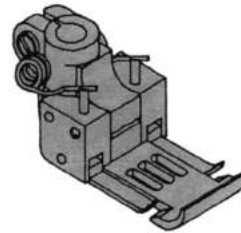

17-7940-1
Piedino

mm		Codice N.
1/8"	3.17	17-7240-1
5/32"	3.97	17-7340-1
3/16"	4.76	17-7440-1
7/32"	5.56	17-7540-1
1/4"	6.35	17-7640-1
* 7/32"	5.56	17-7840-1
* 1/4"	6.35	17-7940-1

* 3 Aghi

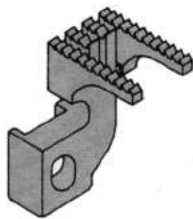

15-9070-0
Griffa posteriore

mm		Codice N.
1/8"	3.17	15-9150-0
5/32"	3.97	15-9150-0
3/16"	4.76	15-9070-0
7/32"	5.56	15-9070-0
1/4"	6.35	15-9070-0

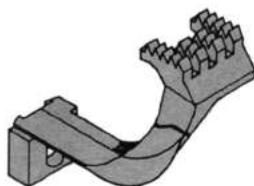

15-9030-0
Griffa anteriore

mm		Codice N.
1/8"	3.17	15-9140-0
5/32"	3.97	15-9140-0
3/16"	4.76	15-9030-0
7/32"	5.56	15-9030-0
1/4"	6.35	15-9030-0

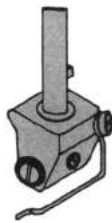

12-8020-1
Morsetto ago

	mm	Codice N.	
1/8"	4.76	12-8130-1	2 Aghi
7/32"	5.56	12-8140-1	
1/4"	6.35	12-8150-1	
7/32"	5.56	12-8010-1	3 Aghi
1/4"	6.35	12-8020-1	

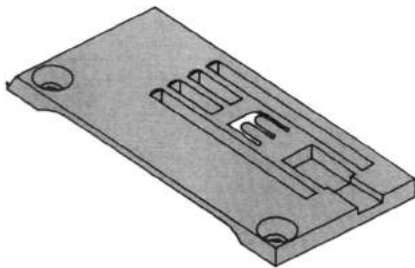

14-8630
Placca ago

	mm	Codice N.	
3/16"	4.76	14-8500-0	2 Aghi
7/32"	5.56	14-8510-0	
1/4"	6.35	14-8520-0	
7/32"	5.56	14-8530-0	3 Aghi
1/4"	6.35	14-8630-0	

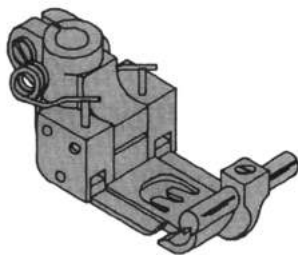

17-8970-N
Piedino

	mm	Codice N.
3/16"	4.76	17-8470-N
7/32"	5.56	17-8570-N
1/4"	6.35	17-8670-N
7/32"	5.56	17-8870-N
1/4"	6.35	17-8970-N

* 3 Aghi

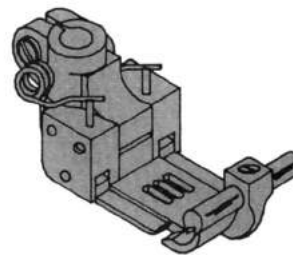

17-7970-N
Piedino

	mm	Codice N.
3/16"	4.76	17-7470-N
7/32"	5.56	17-7570-N
1/4"	6.35	17-7670-N
7/32"	5.56	17-7870-N
1/4"	6.35	17-7970-N

* 3 Aghi

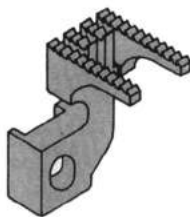

15-9070-0
Griffa posteriore

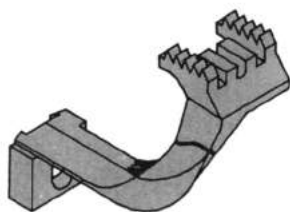

15-9020-0
Griffa anteriore

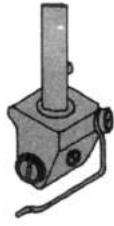

12-8020-1
Morsetto ago

	mm	Codice N.	
1/8"	3.17	12-8110-1	2 Aghi
5/32"	3.97	12-8120-1	
3/16"	4.76	12-8130-1	
7/32"	5.56	12-8140-1	
1/4"	6.35	12-8150-1	3 Aghi
7/32"	5.56	12-8010-1	
1/4"	6.35	12-8020-1	

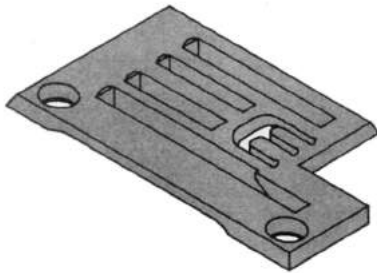

14-8660-0
Placca ago

	mm	Codice N.	
1/8"	3.17	14-7260-0	2 Aghi
5/32"	3.97	14-7360-0	
3/16"	4.76	14-7460-0	
7/32"	5.56	14-7560-0	
1/4"	6.35	14-7660-0	
7/32"	5.56	14-8560-0	3 Aghi
1/4"	6.35	14-8660-0	

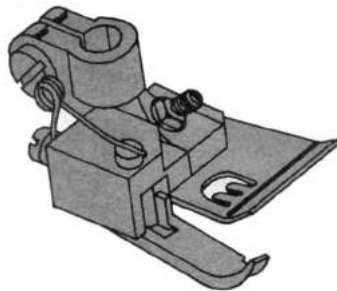

17-8960-1
Piedino

	mm	Codice N.	
1/8"	3.17	17-8260-0	2 Aghi
5/32"	3.97	17-8340-0	
3/16"	4.76	17-8460-0	
7/32"	5.56	17-8560-0	
1/4"	6.35	17-8660-0	
7/32"	5.56	17-8860-0	3 Aghi
1/4"	6.35	17-8960-0	

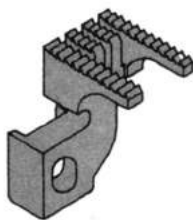

15-9080-0
Griffa posteriore

	mm	Codice N.
1/8"	3.17	15-9110-0
5/32"	3.97	15-9110-0
3/16"	4.76	15-9080-0
7/32"	5.56	15-9080-0
1/4"	6.35	15-9080-0



15-9040-0
Griffa anteriore

	mm	Codice N.
1/8"	3.17	15-9100-0
5/32"	3.97	15-9100-0
3/16"	4.76	15-9040-0
7/32"	5.56	15-9040-0
1/4"	6.35	15-9040-0

LEWIS



4372 M
36-16
Kl. 150



4580 M
36-19
Kl. 160-20



4581 M
36-21
Kl. 200

KI. DLR KANSAI

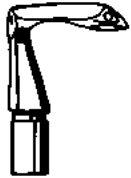

4583 M
19-581

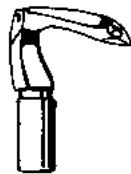

4584 M
19-582

KI. DWR

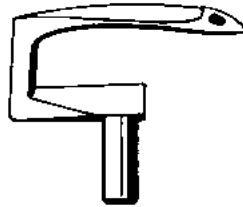

4585 M
19-712

KI. DVK

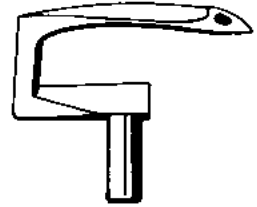

4586 M
19-713

KI. W800

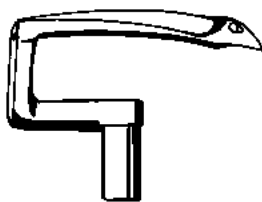

4587 M
19-801

KI. DFB

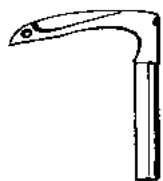

4588 M
19-431



4589 M
19-437



4590 M
19-112

KI. AG



3310 M
AG 315*



3311 M
AG 316*

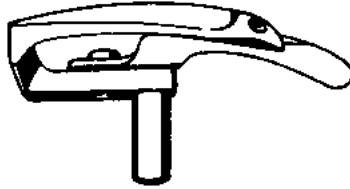

3316 M
AH 37 E
AH 37 D
AH 37 A

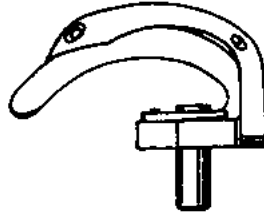

3317 M
CHG 37

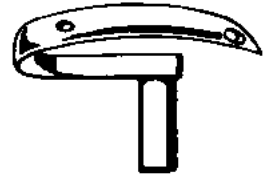

3318 M
AP 37 B

KI. OAH, ODA



3323 M
JABD 816*



3324 M
3103-816*



3325 M
JABD 815*



3326 M
JAB 816 A*



3327 M
JC 816*

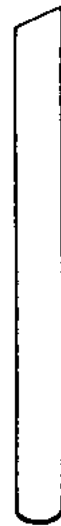

3328 M
JA 815*



3329 M
3101-816*



3330 M
JAB-A 816*

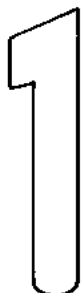

3331 M
JAB-A 815*

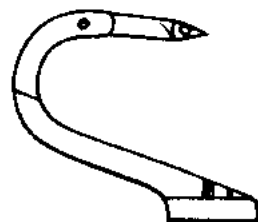

3335 M
J 37 C-R

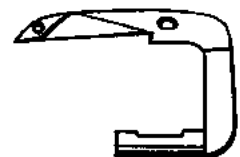

3336 M
J 37 L

Kl. OAH, ODA

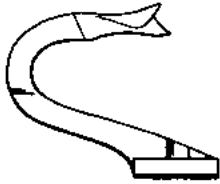

3341 M
JLB 37 R

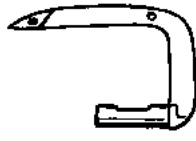

3342 M
JC 37 L

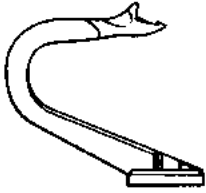

3343 M
JG 37 R

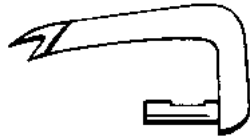

3344 M
JLBD 37 L

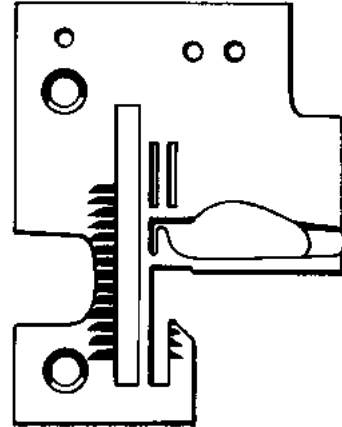

3346 M
3103-35

Kl. C 46 211, C 46 411 Mauserlock Kl. 40



3351 M
ZA 816*



3352 M
CS 816*



3353 M
ZA 815*

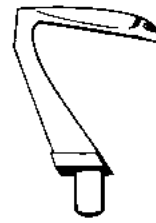

3354 M
700565

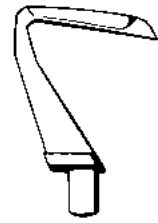

3355 M
CS37 A
700925

Kl. S 1323



3358 M
S 816-6,5*



3359 M
S 816-8*



3360 M
S 815-8*



3361 M
SH 816-8*

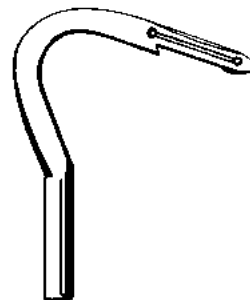

3362 M
S37 BL
720392

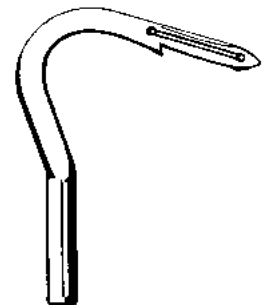

3363 M
SH37 AL
720877

Kl. F 36131

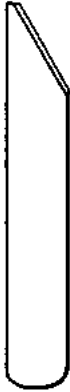

3365 M
PST 815*



3366 M
PST 816*

Kl. FG 23230 GA
Kl. FG 34230 GA



3371 M
PG 815*

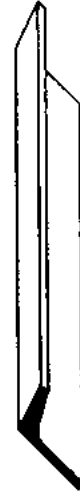

3372 M
PG 816*

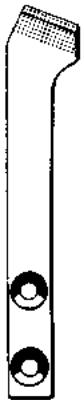

3376 M
08-711 367
con vidia



3377 M
08-705 138*



3378 M
08-705 142*



3379 M
CAM 315*



3380 M
CAM 316*

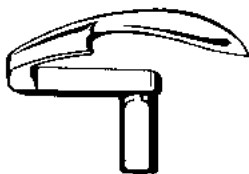

3383 M
ATA 37
702748

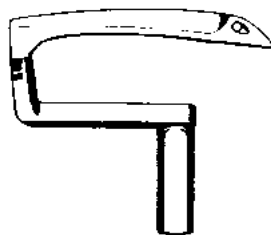

3384 M
F 23100-37 A
710414

Kl. 10, 50

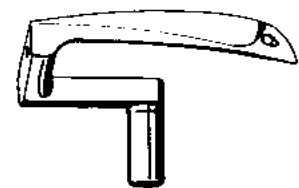

3387 M
E 23100-37 A
712082

KI. 503, 504, 512, 514, 515, 516
 KI. 9632, 9652, 9656, 9732
 KI. 2003, 2004, 2005, 2015, 2016

210755
 CT 210 755 = 91-179 421-01
 211 771 = 09-009 807-71



4209 M
 202 570
 323-870-200
 09-009 052-54



4209 MV
 201 121 A
 323-870-214
 09-009 050-06 (CT)

205 607:
 con vidia



4210 M
 202 571
 323-870-201
 09-009 052-55
 CT =
 2020 527
 323-870-207
 09-009 070-82

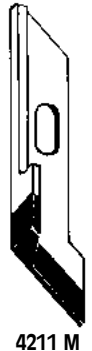

4211 M
 con vidia



4215 M
 202 572
 323-870-202
 09-009 052-56
 202 295
 323-870-210
 09-009 066-42

205 609



4212 M
 202 893
 323-870-215
 (CT)
 con vidia



4216 M
 202 573
 323-870-203
 09-009 052-57
 201 127
 323-870-211
 09-009 054-43

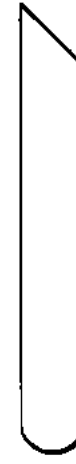

4217 M
 204 161
 323-870-213
 09-009 053-33



4213 M
 204 351
 323-870-218
 (CT)
 con vidia

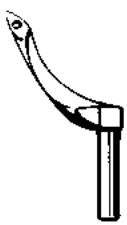

4251 M
 202 874 (1)
 323-810-211
 09-009 053-31

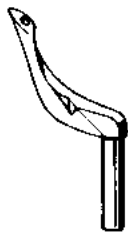

4252 M
 204 062 (2)
 323-810-218
 09-009 054-19

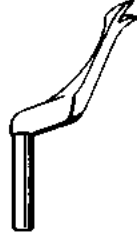

4253 M
 204 278 (1)
 323-810-215
 09-009 054-29

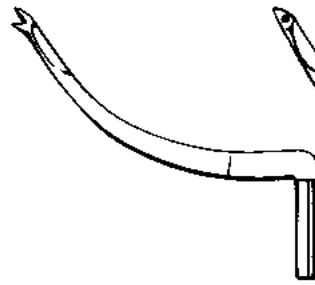

4254 M
 201 234 A
 323-810-003
 09-009 050-62

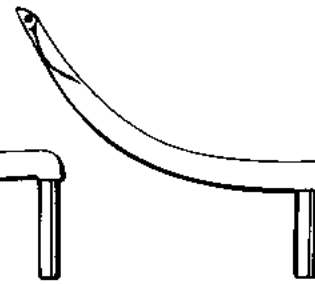

4255 M
 201 067 A
 323-810-001
 09-009 049-43

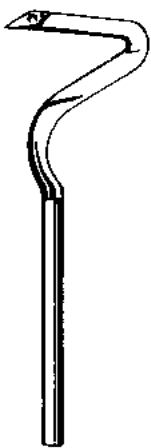

4256 M
 201 085 B
 323-810-002
 09-009 049-56

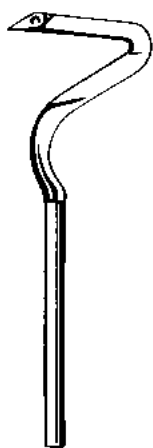

4239 M
 202 861
 323-810-212
 09-009 053-29

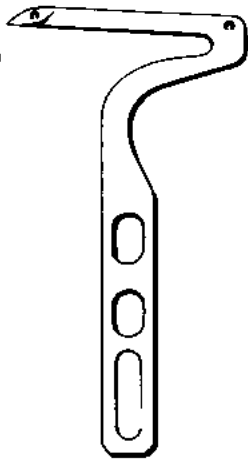

4257 A
 204 072
 323-810-216
 09-009 054-20

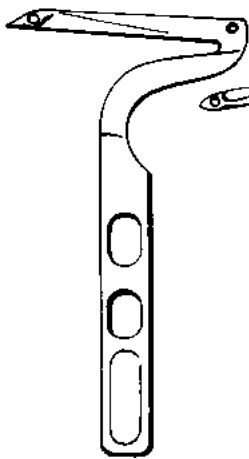

4240 M
 204 991
 323-810-232
 09-009 603-49



4258 M
 204 314 A
 323-810-217
 09-009 065-25

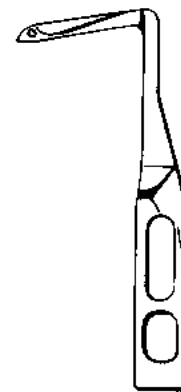

4241 M
 204 431
 323-810-219
 09-009 065-26

Kl. 503, 504, 512, 514, 515, 516
 Kl. 9632, 9652, 9656, 9732
 Kl. 2003, 2004, 2005, 2015, 2016

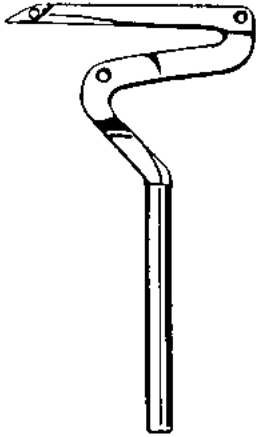

4595 M
 202 703
 323-810-222
 09-009 065-89



4596 M
 202 828 (4)
 323-810-224
 09-009 065-90



4597 M
 204 663 (7)
 323-810-008
 09-009 068-07



4598 M
 204 990 (12)
 323-810-231
 09-009 603-48



4599 M
 204 702 (4)
 323-810-009
 09-009 067-70



4600 M
 204 703 (6)
 323-810-010
 09-009 067-68



4601 M
 204 704 (3)
 323-810-011
 09-009 068-98



4602 M
 204 705 (5)
 323-810-012
 09-009 067-69

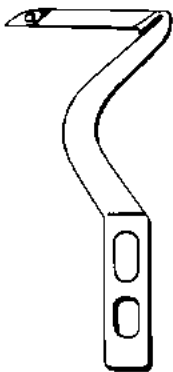

4605 M
 210 354
 323-810-018
 09-009 615-98

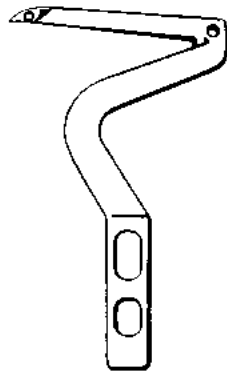

4606 M
 210 356
 323-810-019
 09-009 615-99

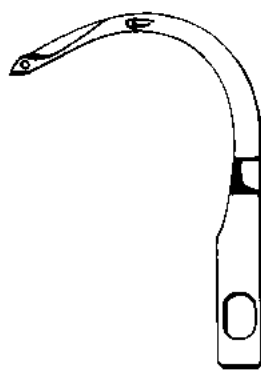

4607 M
 210 357 A
 323-810-020
 09-009 616-00



4603 M
 210 358 (2)
 323-810-021
 09-009 620-31



4604 M
 210 359 (4)
 323-810-022
 09-009 616-01



4608 M
 210 364 (22)
 323-810-025
 09-009 616-03



4609 M
 210 365 (24)
 323-810-026
 09-009 616-04



4610 M
 210 366 (26)
 323-810-027
 09-009 620-33

Kl. 503, 504, 512, 514, 515, 516
 Kl. 9632, 9652, 9656, 9732
 Kl. 2003, 2004, 2005, 2015, 2016

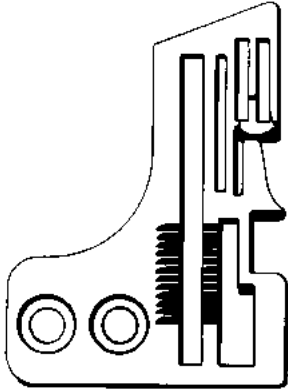

4611 M
 205 321
 09-009 611-37

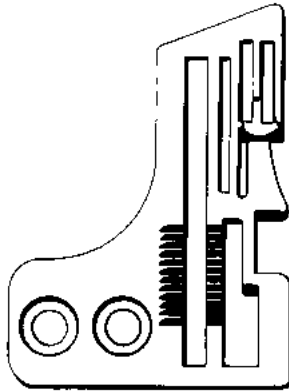

4612 M
 205 322
 09-009 070-90

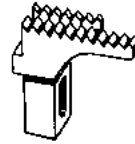

4613 M
 208 336
 09-009 611-68



4614 M
 208 338
 09-009 611-70

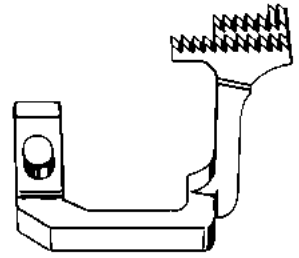

4615 M
 204 907
 09-009 068-97

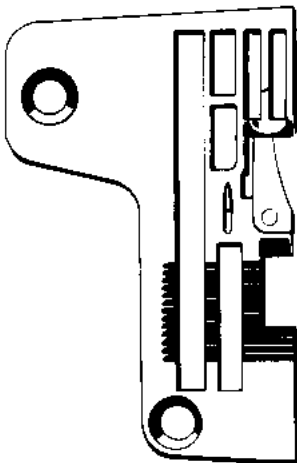

4616 M
 204 252 B
 09-009 065-65

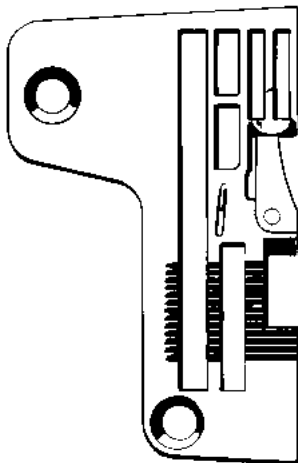

4617 M
 204 360 A
 09-009 065-40

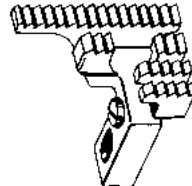

4618 M
 208 063
 09-009 071-19

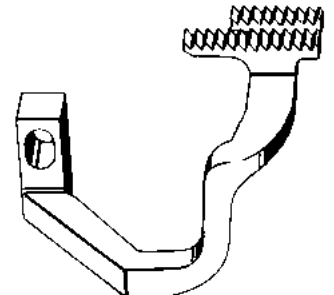

4619 M
 208 215
 09-009 071-27

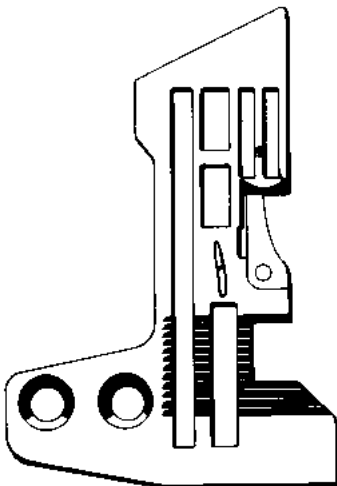

4620 M
 210 846
 09-009 620-09

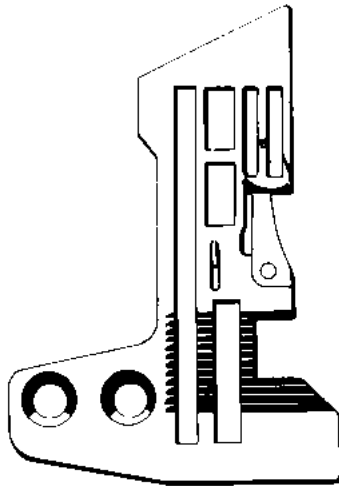

4621 M
 210 851
 09-009 620-14

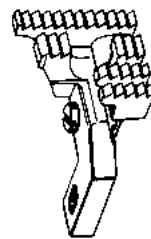

4622 M
 210 581
 09-009 606-75

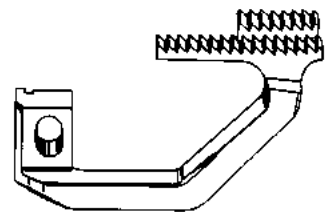

4623 M
 210 494
 09-009 616-98

Kl. 503, 504, 512, 514, 515, 516
 Kl. 9632, 9652, 9656, 9732
 Kl. 2003, 2004, 2005, 2015, 2016

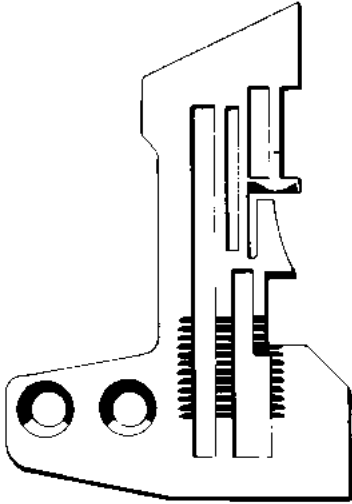

4624 M
 210 787
 09-099 620-45

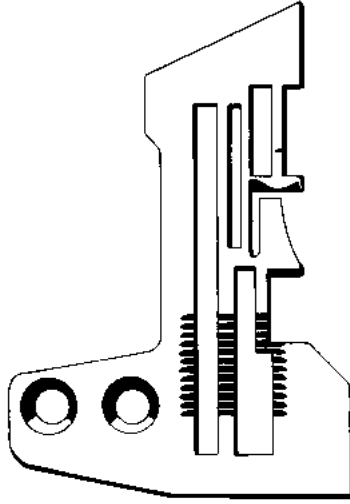

4625 M
 210 788
 09-099 620-46



4626 M
 210 568
 09-099 617-26

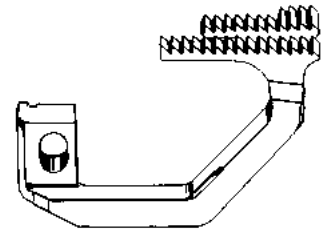

4627 M
 210 443
 09-099 616-57

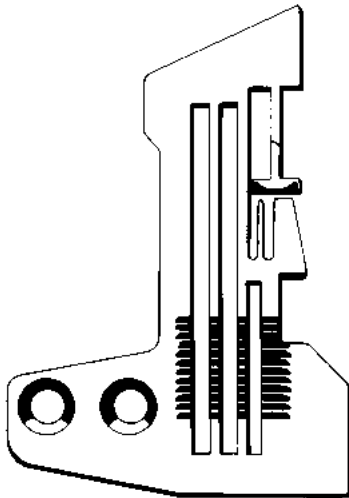

4628 M
 210 810
 09-099 620-66



4629 M
 210 575
 09-099 617-33

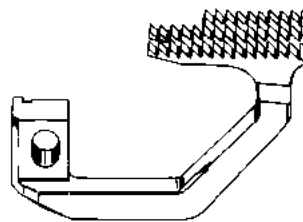

4630 M
 210 445
 09-099 616-58

Kl. 68
 = Treasure Kl. B S 80
 bis 812



4711 M
 96-795 104-00
 11 837 (T 830)

Kl. 4542, 4562
 = Pegasus W 542, W 562

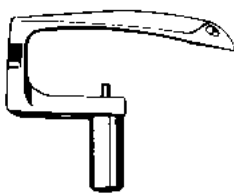

4632 M
 257 550

**Diversi pezzi per Mauser sono
 identici ai pezzi delle macchine
 W-G. e PEGASUS**



3391 M
90 C*



3392 M
90 D*



3393 M
6-90*



3394 M
90-A 1*
scanalato



3395 M
A 90-3*



3400 M
6-91 K



3401 M
6-91*



3402 M
6-91 E*

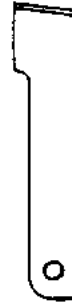

3403 M
6-91 C*



3404 M
6-91 H*



3410 M
59



3405 M
69



3406 M
72



3407 M
105

KI. 405-100
Per Asole = PFAFF 3114

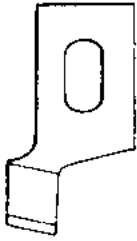

3575 M
mm 6-7-9-11

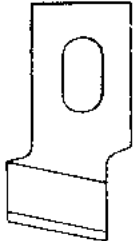

3576 M
mm 12-14-16-19

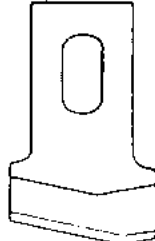

3577 M
mm 22-25

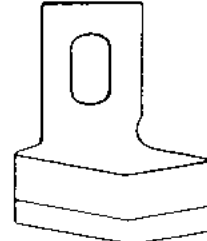

3578 M
mm 28-31

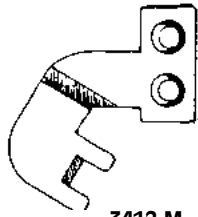

3412 M
154 851 000

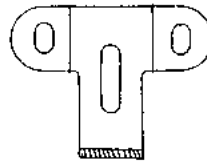

3413 M
154 852 000

KI. 835-263

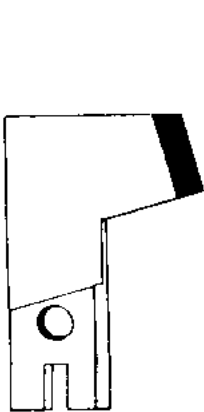

3414 M
186 188 200 (CT)
con vidia

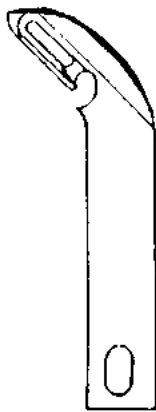

3415 M
186 185 000

KI. UAN 1701

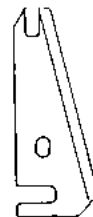

3616 M
181 814 000
= 40-0127-2-000
(REECE)

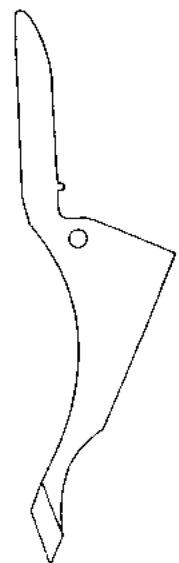

3416 M
181 812 000 HSS

PLACCHE-GRIFFE TIPO NECCHI

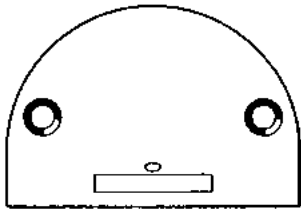

2730

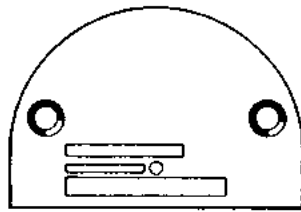

42611

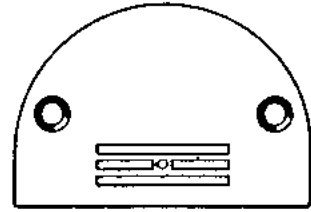

52046

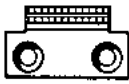

2728

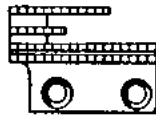

42600

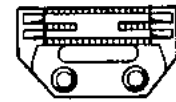

122622

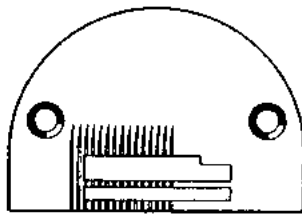

956333

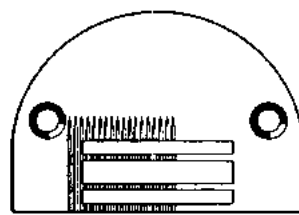

146111

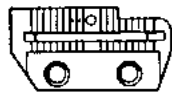

956334

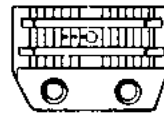

146622

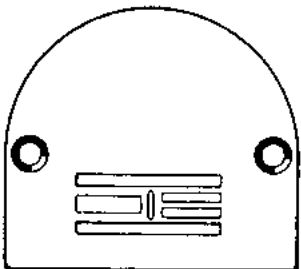

956141

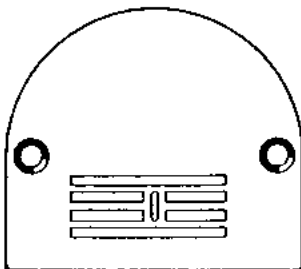

956190

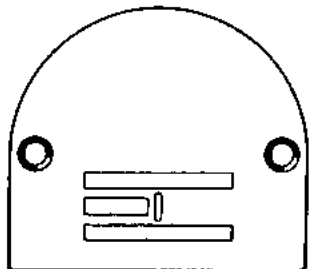

110111

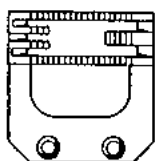

956142

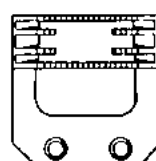

956220

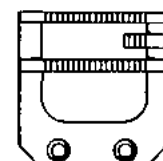

956046

PLACCHE-GRIFFE TIPO NECCHI

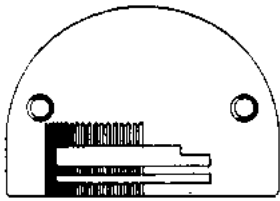

956493

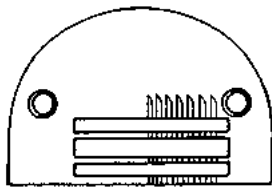

956526

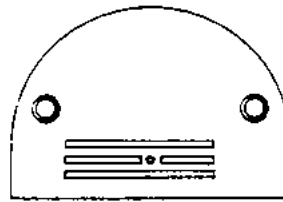

52046-0-20

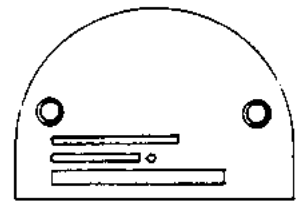

956020

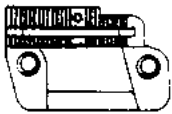

956491



956527

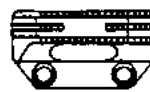

122622-0-20



42600-0-20

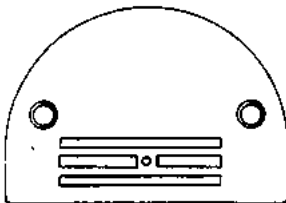

956652

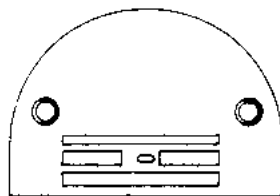

956515

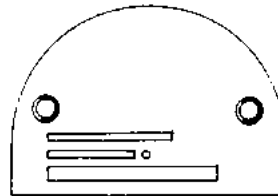

956020

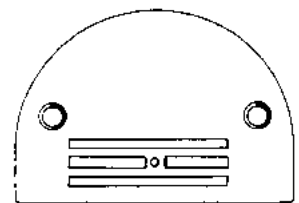

956652



956654

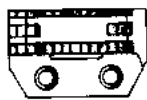

956516

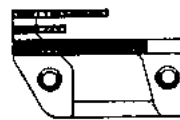

956492



956655

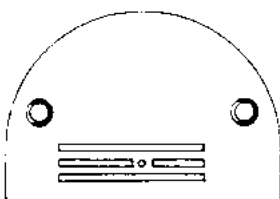

52046-0-20

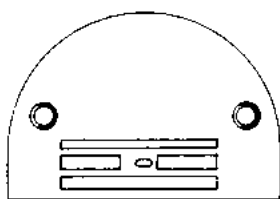

956515



956528

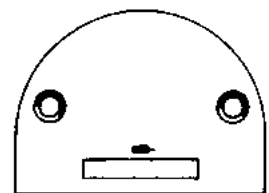

956016



186622-0-20

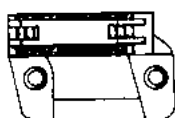

956534



956529



956017

PIEDINI NECCHI



90315



109639

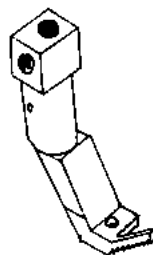

90330

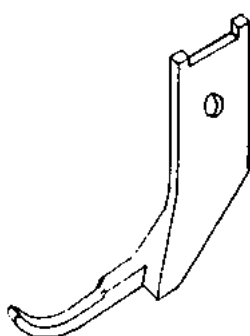

956523D

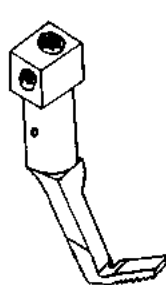

956522D

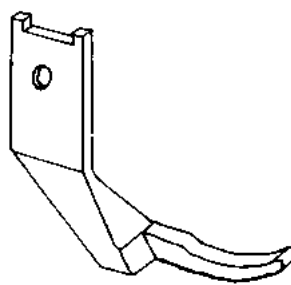

956523S

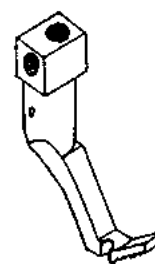

956522S



155111



155622

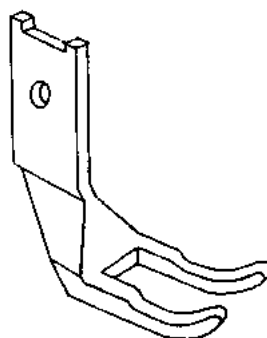

155409

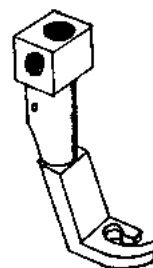

155639

PIASTRE PER BORDARE



NE 840
10196 CPL



NE 902
902-0151

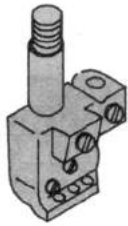

257518-64
Morsetto ago

mm	Codice N.	
2.4	257517-24	2 Aghi
3.2	257517-32	
4.0	257517-40	
4.8	257517-48	
5.6	257517-56	
6.4	257517-64	3 Aghi
4.8	257518-48	
5.6	257518-56	
6.4	257518-64	

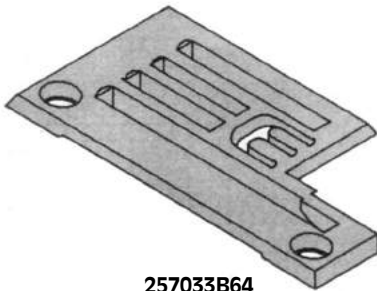

257033B64
Placca ago

mm	Codice N.	
2.4	257029B24	2 Aghi
3.2	257029B32	
4.0	257030B40	
4.8	257030B48	
5.6	257032B56	
6.4	257032B64	3 Aghi
4.8	257031B48	
5.6	257033B56	
6.4	257033B64	

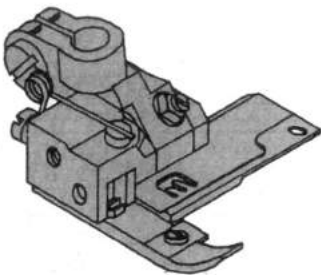

257321A64
Piedino * 3 Aghi

mm	Codice N.
2.4	257317A24
3.2	257317A32
4.0	257318A40
4.8	257318A48
5.6	257319A56
6.4	257319A64
* 4.8	257320A48
* 5.6	257321A56
* 6.4	257321A64

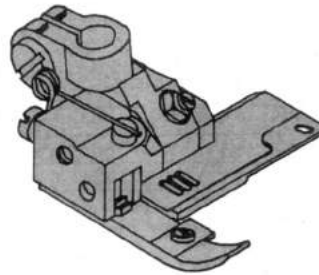

257326A64
Piedino * 3 Aghi

mm	Codice N.
2.4	257322A24
3.2	257322A32
4.0	257323A40
4.8	257323A48
5.6	257324A56
6.4	257324A64
* 4.8	257325A48
* 5.6	257326A56
* 6.4	257326A64

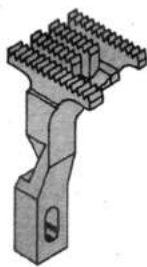

257216-16F
Griffa posteriore

mm	Codice N.	
2.4	257214-16F	2 Aghi
3.2	257214-16F	
4.0	257215-16F	
4.8	257215-16F	
5.6	257216-16F	
6.4	257216-16F	3 Aghi
4.8	257215-16F	
5.6	257216-16F	
6.4	257216-16F	



257262-16F
Griffa anteriore

mm	Codice N.	
2.4	257260-16F	2 Aghi
3.2	257260-16F	
4.0	257261-16F	
4.8	257261-16F	
5.6	257262-16F	
6.4	257262-16F	3 Aghi
4.8	257261-16F	
5.6	257262-16F	
6.4	257262-16F	

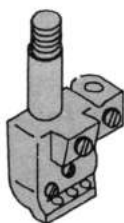

257518-64
Morsetto ago

mm	Codice N.	
2.4	257517-24	2 Aghi
3.2	257517-32	
4.0	257517-40	
4.8	257517-48	
5.6	257517-56	
6.4	257517-64	3 Aghi
4.8	257518-48	
5.6	257518-56	
6.4	257518-64	

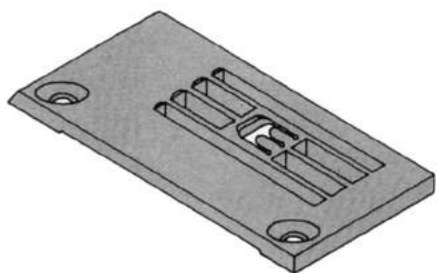

257018A64
Placca ago

mm	Codice N.	
2.4	257015A24	2 Aghi
3.2	257015A32	
4.0	257015A40	
4.8	257015A48	
5.6	257015A56	
6.4	257015A64	3 Aghi
4.8	257016A48	
5.6	257018A56	
6.4	257018A64	

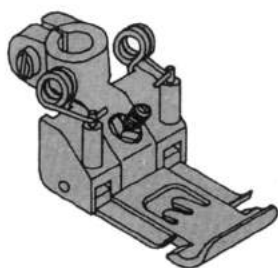

257301A64
Piedino

mm	Codice N.
4.0	257300A40
4.8	257300A48
5.6	257300A56
6.4	257300A64
* 4.8	257301A48
* 5.6	257301A56
* 6.4	257301A64

* 3 Aghi

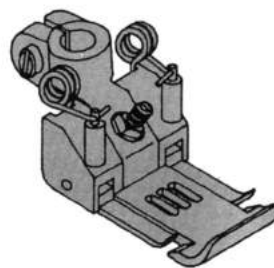

257303A64
Piedino

mm	Codice N.
2.4	257302A24
3.2	257302A32
4.0	257302A40
4.8	257302A48
5.6	257302A56
6.4	257302A64
* 4.8	257303A48
* 5.6	257303A56
* 6.4	257303A64

* 3 Aghi

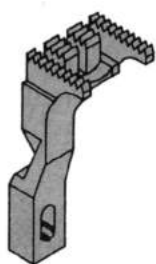

257207-16F
Griffa posteriore

mm	Codice N.	
2.4	257206-16F	2 Aghi
3.2	257206-16F	
4.0	257206-16F	
4.8	257206-16F	
5.6	257207-16F	
6.4	257207-16F	3 Aghi
4.8	257206-16F	
5.6	257207-16F	
6.4	257207-16F	

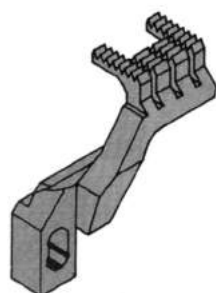

257259-16F
Griffa anteriore

mm	Codice N.	
2.4	257258-16F	2 Aghi
3.2	257258-16F	
4.0	257258-16F	
4.8	257258-16F	
5.6	257259-16F	
6.4	257259-16F	3 Aghi
4.8	257258-16F	
5.6	257259-16F	
6.4	257259-16F	

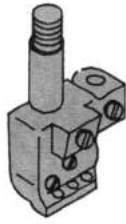

257518-64
Morsetto ago

mm	Codice N.	
4.0	257517-40	2 Aghi
4.8	257517-48	
5.6	257517-56	
6.4	257517-64	
4.8	257518-48	3 Aghi
5.6	257518-56	
6.4	257518-64	

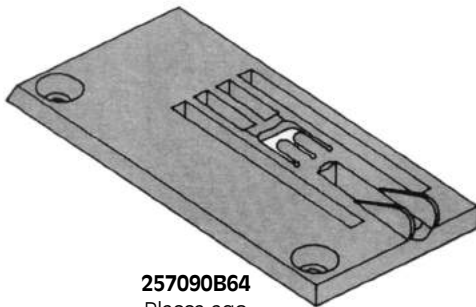

257090B64
Placca ago

mm	Codice N.	
4.0	257087B40	2 Aghi
4.8	257087B48	
5.6	257089B56	
6.4	257089B64	
4.8	257088B48	3 Aghi
5.6	257090B56	
6.4	257090B64	

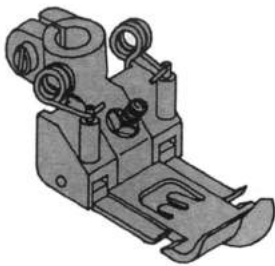

257404-64
Piedino

mm	Codice N.
4.0	257403-40
4.8	257403-48
5.6	257403-56
6.4	257403-64
* 4.8	257404-48
* 5.6	257404-56
* 6.4	257404-64

* 3 Aghi

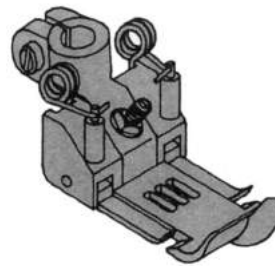

257406-64
Piedino

mm	Codice N.
4.0	257405-40
4.8	257405-48
5.6	257405-56
6.4	257405-64
* 4.8	257406-48
* 5.6	257406-56
* 6.4	257406-64

* 3 Aghi



257207-16F
Griffa posteriore

mm	Codice N.	
4.0	257206-16F	2 Aghi
4.8	257206-16F	
5.6	257206-16F	
6.4	257206-16F	
4.8	257206-16F	3 Aghi
5.6	257207-16F	
6.4	257207-16F	

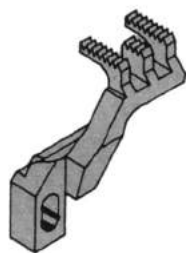

257253-16F
Griffa anteriore

mm	Codice N.	
4.0	257200-16F	2 Aghi
4.8	257200-16F	
5.6	257253-16F	
6.4	257253-16F	
4.8	257200-16F	3 Aghi
5.6	257253-16F	
6.4	257253-16F	

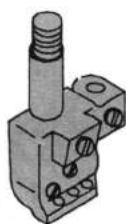

257518-64
Morsetto ago

mm	Codice N.	
4.0	257517-40	2 Aghi
4.8	257517-48	
5.6	257517-56	
6.4	257517-64	
4.8	257518-48	3 Aghi
5.6	257518-56	
6.4	257518-64	

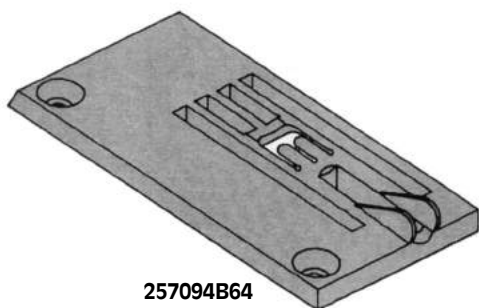

257094B64
Placca ago

mm	Codice N.	
4.0	257091B40	2 Aghi
4.8	257091B48	
5.6	257093B56	
6.4	257093B64	
4.8	257092B48	3 Aghi
5.6	257094B56	
6.4	257094B64	

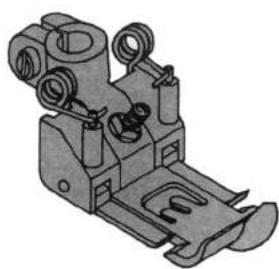

257404-64
Piedino

mm	Codice N.
4.0	257403-40
4.8	257403-48
5.6	257403-56
6.4	257403-64
* 4.8	257404-48
* 5.6	257404-56
* 6.4	257404-64

* 3 Aghi

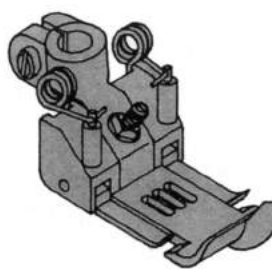

257406-64
Piedino

mm	Codice N.
4.0	257405-40
4.8	257405-48
5.6	257405-56
6.4	257405-64
* 4.8	257406-48
* 5.6	257406-56
* 6.4	257406-64

* 3 Aghi

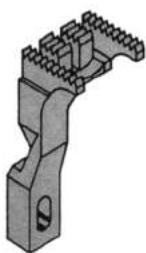

257207-16F
Griffa posteriore

mm	Codice N.	
4.0	257206-16F	2 Aghi
4.8	257206-16F	
5.6	257207-16F	
6.4	257207-16F	
4.8	257206-16F	3 Aghi
5.6	257207-16F	
6.4	257207-16F	

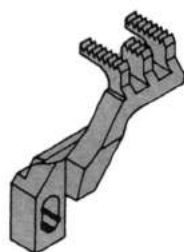

257254-16F
Griffa anteriore

mm	Codice N.	
4.0	257201-16F	2 Aghi
4.8	257201-16F	
5.6	257254-16F	
6.4	257254-16F	
4.8	257201-16F	3 Aghi
5.6	257254-16F	
6.4	257254-16F	

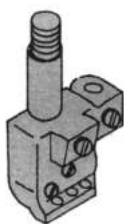

257518-64
Morsetto ago

mm	Codice N.	
2.4	257517-24	2 Aghi
3.2	257517-32	
4.0	257517-40	
4.8	257517-48	
5.6	257517-56	
6.4	257517-64	3 Aghi
4.8	257518-48	
5.6	257518-56	
6.4	257518-64	

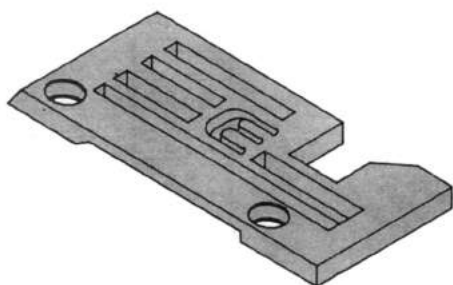

257053B64
Placca ago

mm	Codice N.	
2.4	257049B24	2 Aghi
3.2	257049B32	
4.0	257050B40	
4.8	257050B48	
5.6	257052B56	
6.4	257052B64	3 Aghi
4.8	257051B48	
5.6	257053B56	
6.4	257053B64	

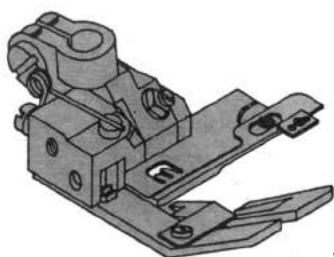

257331A64
Piedino * 3 Aghi

mm	Codice N.
2.4	257327A24
3.2	257327A32
4.0	257328A40
4.8	257328A48
5.6	257329A56
6.4	257329A64
* 4.8	257330A48
* 5.6	257331A56
* 6.4	257331A64

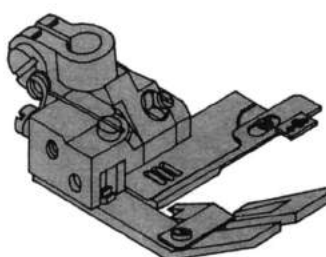

257336A64
Piedino * 3 Aghi

mm	Codice N.
2.4	257332A24
3.2	257332A32
4.0	257333A40
4.8	257333A48
5.6	257334A56
6.4	257334A64
* 4.8	257335A48
* 5.6	257336A56
* 6.4	257336A64

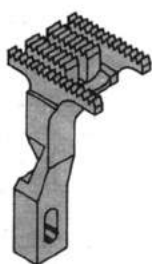

257222-16F
Griffa posteriore

mm	Codice N.	
2.4	257220-16F	2 Aghi
3.2	257220-16F	
4.0	257221-16F	
4.8	257221-16F	
5.6	257222-16F	
6.4	257222-16F	3 Aghi
4.8	257221-16F	
5.6	257222-16F	
6.4	257222-16F	

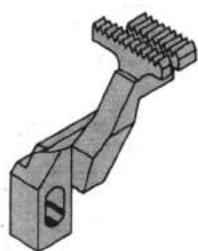

257268-16F
Griffa anteriore

mm	Codice N.	
2.4	257266-16F	2 Aghi
3.2	257266-16F	
4.0	257267-16F	
4.8	257267-16F	
5.6	257268-16F	
6.4	257268-16F	3 Aghi
4.8	257267-16F	
5.6	257268-16F	
6.4	257268-16F	

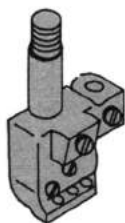

257518-64
Morsetto ago

mm	Codice N.	
2.4	257517-24	2 Aghi
3.2	257517-32	
4.0	257517-40	
4.8	257517-48	
5.6	257517-56	
6.4	257517-64	3 Aghi
4.8	257518-48	
5.6	257518-56	
6.4	257518-64	

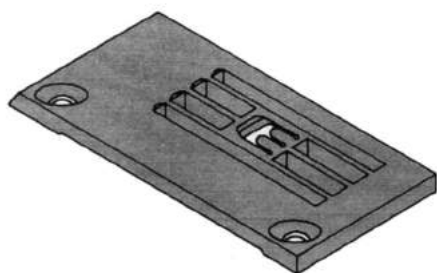

257018B64
Placca ago

mm	Codice N.	
2.4	257015B24	2 Aghi
3.2	257015B32	
4.0	257015B40	
4.8	257015B48	
5.6	257017B56	
6.4	257017B64	3 Aghi
4.8	257016B48	
5.6	257018B56	
6.4	257018B64	

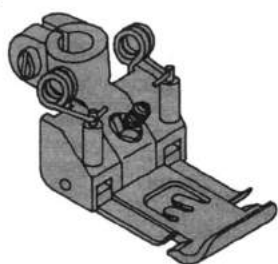

257301A64
Piedino * 3 Aghi

mm	Codice N.
2.4	257300A24
3.2	257300A32
4.0	257300A40
4.8	257300A48
5.6	257300A56
6.4	257300A64
* 4.8	257301A48
* 5.6	257301A56
* 6.4	257301A64

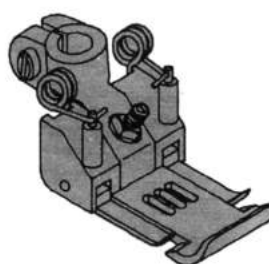

257303A64
Piedino * 3 Aghi

mm	Codice N.
2.4	257302A24
3.2	257302A32
4.0	257302A40
4.8	257302A48
5.6	257302A56
6.4	257302A64
* 4.8	257303A48
* 5.6	257303A56
* 6.4	257303A64

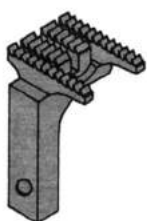

257243-16F
Griffa posteriore

mm	Codice N.	
2.4	257242-16F	2 Aghi
3.2	257242-16F	
4.0	257242-16F	
4.8	257242-16F	
5.6	257243-16F	
6.4	257243-16F	3 Aghi
4.8	257242-16F	
5.6	257243-16F	
6.4	257243-16F	

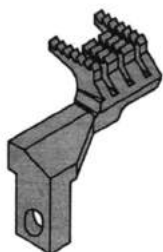

257290-16F
Griffa anteriore

mm	Codice N.	
2.4	257289-16F	2 Aghi
3.2	257289-16F	
4.0	257289-16F	
4.8	257289-16F	
5.6	257290-16F	
6.4	257290-16F	3 Aghi
4.8	257289-16F	
5.6	257290-16F	
6.4	257290-16F	

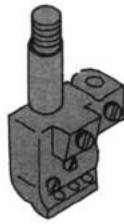

257518-64
Morsetto ago

mm	Codice N.	
3.2	257517-32	2 Aghi
4.0	257517-40	
4.8	257517-48	
5.6	257517-56	
6.4	257517-64	3 Aghi
5.6	257518-56	
6.4	257518-64	

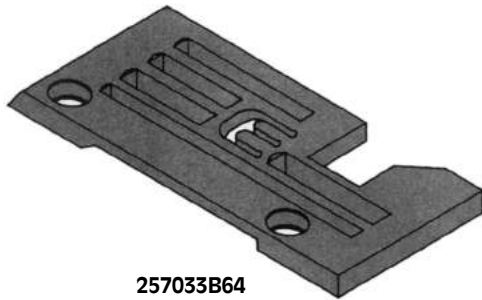

257033B64
Placca ago

mm	Codice N.	
3.2	257029B32	2 Aghi
4.0	257030B40	
4.8	257030B48	
5.6	257032B56	
6.4	257032B64	3 Aghi
5.6	257033B56	
6.4	257033B64	

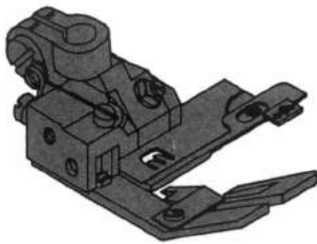

257321A64
Piedino

mm	Codice N.
3.2	257317A32
4.0	257318A40
4.8	257318A48
5.6	257319A56
6.4	257319A64
* 5.6	257321A56
* 6.4	257321A64

* 3 Aghi

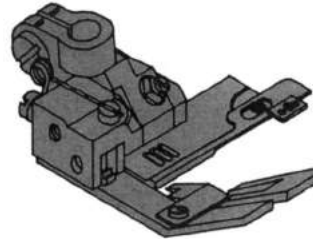

257326A64
Piedino

mm	Codice N.
3.2	257322A32
4.0	257323A40
4.8	257323A48
5.6	257324A56
6.4	257324A64
* 5.6	257326A56
* 6.4	257326A64

* 3 Aghi

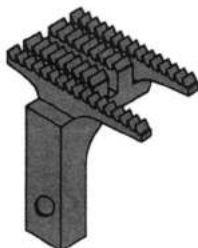

257246-16F
Griffa posteriore

mm	Codice N.	
3.2	257244-16F	2 Aghi
4.0	257245-16F	
4.8	257245-16F	
5.6	257246-16F	
6.4	257246-16F	3 Aghi
5.6	257246-16F	
6.4	257246-16F	

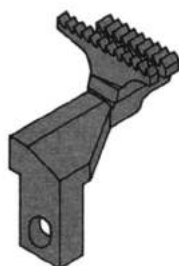

257293-16F
Griffa anteriore

mm	Codice N.	
3.2	257291-16F	2 Aghi
4.0	257292-16F	
4.8	257292-16F	
5.6	257293-16F	
6.4	257293-16F	3 Aghi
5.6	257293-16F	
6.4	257293-16F	

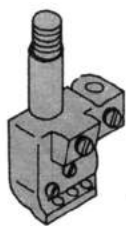

257518-64
Morsetto ago

mm	Codice N.	
3.2	257517-32	2 Aghi
4.0	257517-40	
4.8	257517-48	
5.6	257517-56	
6.4	257517-64	3 Aghi
5.6	257518-56	
6.4	257518-64	

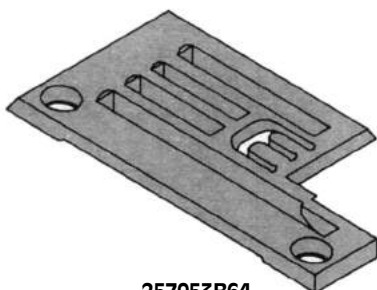

257053B64
Placca ago

mm	Codice N.	
3.2	257049B32	2 Aghi
4.0	257050B40	
4.8	257050B48	
5.6	257052B56	
6.4	257052B64	3 Aghi
5.6	257053B56	
6.4	257053B64	

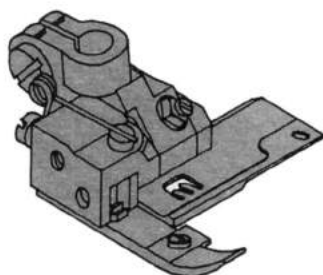

257421-64
Piedino

mm	Codice N.
3.2	257418A32
4.0	257419A40
4.8	257419A48
5.6	257420A56
6.4	257420A64
* 5.6	257421A56
* 6.4	257421A64

* 3 Aghi

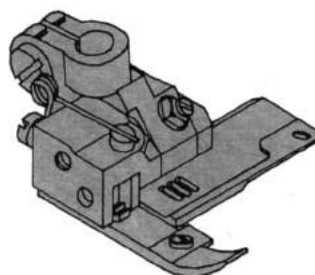

257425-64
Piedino

mm	Codice N.
3.2	257422-32
4.0	257423-32
4.8	257423-32
5.6	257424-32
6.4	257424-32
* 5.6	257425-32
* 6.4	257425-32

* 3 Aghi

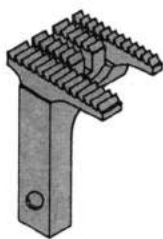

259106-16F
Griffa posteriore

mm	Codice N.	
3.2	257104-16F	2 Aghi
4.0	257105-16F	
4.8	257105-16F	
5.6	257106-16F	
6.4	257106-16F	3 Aghi
5.6	257106-16F	
6.4	257106-16F	

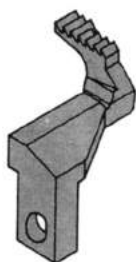

259218-16F
Griffa anteriore

mm	Codice N.	
3.2	257216-16F	2 Aghi
4.0	257217-16F	
4.8	257217-16F	
5.6	257218-16F	
6.4	257218-16F	3 Aghi
5.6	257218-16F	
6.4	257218-16F	

Kl. Industria (Metro)



3421 M
60-082*



3422 M
60-066 C*



3423 M
60-082 A*



3424 M
60-066 CA*

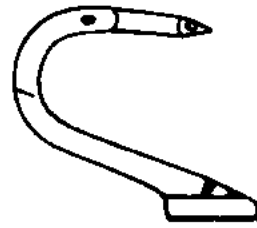

3428 M
60-148

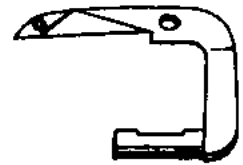

3429 M
60-152

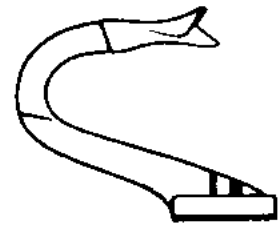

3430 M
60-154

Kl. 133—31 S, 134—31 S



3435 M
15323*



3436 M
15320*
2—6 mm

Kl. 141/134—431
Kl. 143/134—431



3448 M
19506x5



3449 M
19506x7

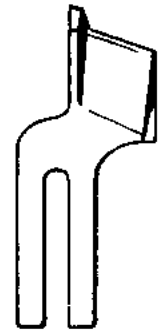

3450 M
19506x9

Kl. 471, 491



3517 M

91—058 288—0,8 A x 4,5
91—058 288—1,0 A x 4,5
91—058 288—1,2 A x 4,5

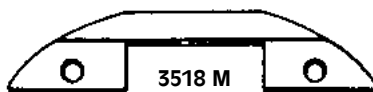

3518 M

91—058 309—1,0 A x 4,5
91—058 309—1,2 A x 4,5



3519 M
119 202



3519 ME
119 202 HSS



3520 M
119 444

Kl. 142—131/7—293/2 (732)

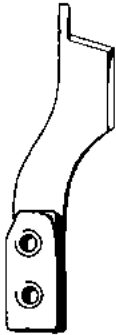

3460 M
10273

Kl. 142—131/7—293/2 (732)



3465 M
113460



3466 M
10192

Kl. 142—732



3470 M
48 908—10—20

Kl. 151—431
Kl. 153—431

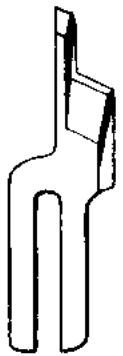

3475 M
15435 x 5



3476 M
15435 x 7

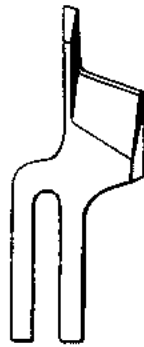

3477 M
15435 x 9

Kl. 155—431
Kl. 175—431

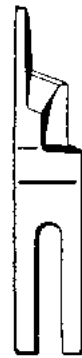

3481 M
19737 x 5



3482 M
19737 x 7

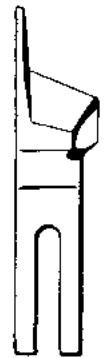

3483 M
19737 x 9

Kl. 143, 191, 193

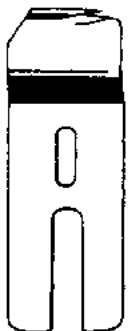

3490 M
11 233 x 2,7
11 233 x 3,1
11 233 x 3,5



3491 M
11 255

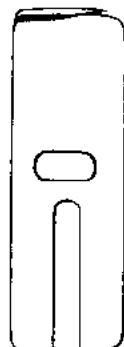

3492 M
11 165 x 2,7
11 165 x 3,1
11 165 x 3,5

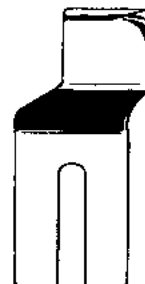

3493 M
11 324 x 2,7
11 324 x 3,1
11 324 x 3,5

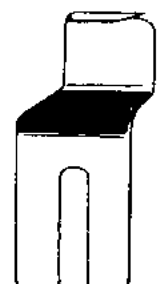

3494 M
11 179 x 2,7
11 179 x 3,1
11 179 x 3,5
11 179 x 4,0

Kl. 460/900



3531 M
169 239 x 0,8



3532 M
169 239 x 1,0

Kl. 461—431 bis 469—431



3538 M
69 595 x 5"



3539 M
69 595 x 7"



3540 M
69 595 x 9"

Kl. 461—431 bis 469—431
Kl. 5467—531
Kl. 5487—733



3545 M
69 669 x 5,0*



3546 M
69 669 x 7,0*



3547 M
69 669 x 9,0*



3549 M
91-175 540-05

Kl. 481, 483, 487



3553 M
171 853

Kl. 463—431, 461—431



3559 M
069 596
con vidia

Kl. 463, 465, 467
Kl. 469—431



3560 M
069 085
con vidia

Kl. 483 bis 487—731



3565 M
169 395 x 5,0*



3566 M
169 395 x 7,0*



3567 M
169 395 x 9,0*

Kl. 3114
Kl. 20 241

PER ASOLE



3575 M
mm 6-7-9-11



3576 M
mm 12-14-16-19

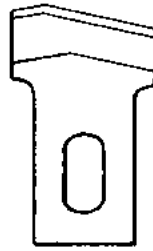

3577 M
mm 22-25

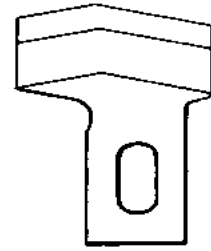

3578 M
mm 28-31

Kl. 3334

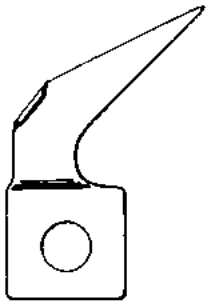

3579 M
22452

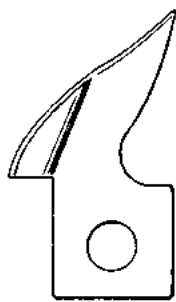

3580 M
22453

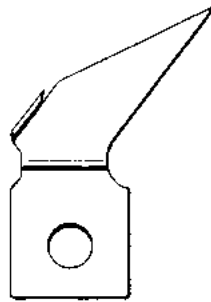

3581 M
22096

Kl. 5642

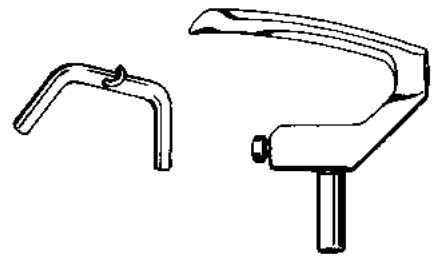

3582 M
91-172 802-01 91-172 797-05
91-176 055-91

Kl. 5463, 5467
Kl. 5483, 5487, 5489

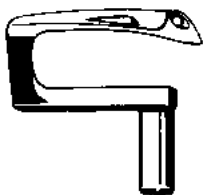

3583 M
91-170 966-05

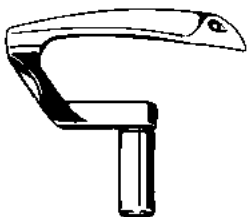

3584 M
91-169 711-05

Kl. 5480—900



3595 M
172 358
vecchio Nr. 172 071

Kl. 5483—802—733

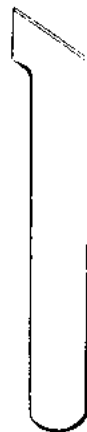

3600 M
170 416*

Kl. 5487—801—733

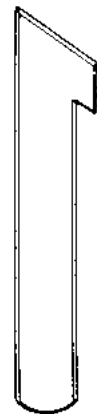

3605 M
170 415*

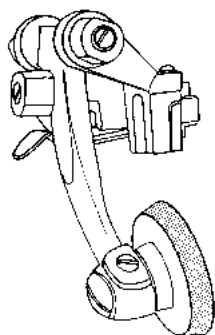

46180 EX

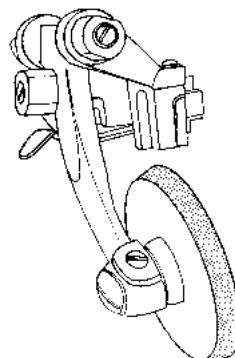

46182 EX

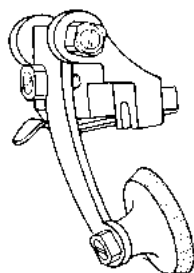

48180 SF
46180

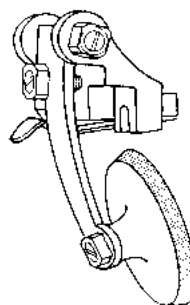

48182 SF
46182

N. di catalogo N. di descrizione	N. originale	Descrizione articolo
46180 EX	46180	Piedino a ruota ribaltabile mm 22, tipo originale
46182 EX	46182	Piedino a ruota ribaltabile mm 32, tipo originale
46180 SF		Piedino a ruota ribaltabile mm 22, a sfere
46182 SF		Piedino a ruota ribaltabile mm 32, a sfere
46180		Piedino a ruota ribaltabile mm 22
46182		Piedino a ruota ribaltabile mm 32

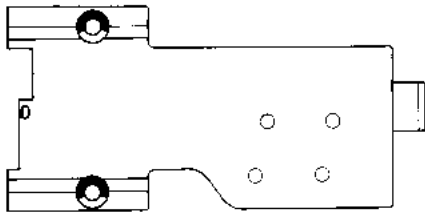

4544

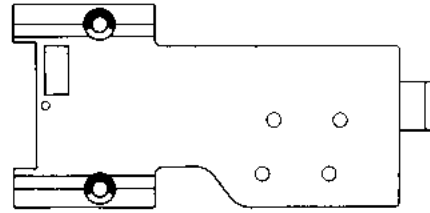

46280

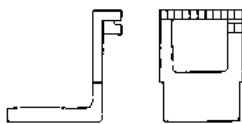

25748

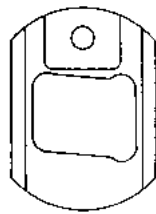

4535

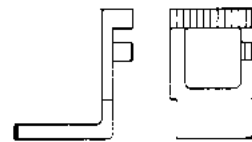

26316



4317



4403

N. di catalogo N. di descrizione	N. originale	Descrizione articolo
4544	4544	Placca ago 28-9
25748	25748	Griffa 28-9
6064	4317	Crochet 28-9
46280	46280	Placca ago 28-10
26316	26316	Griffa 28-10
6066	4403	Crochet 28-10
4535	4535	Slitta porta griffa 28-9 28-10

AGO SCHMETZ SIST. 34R 134R

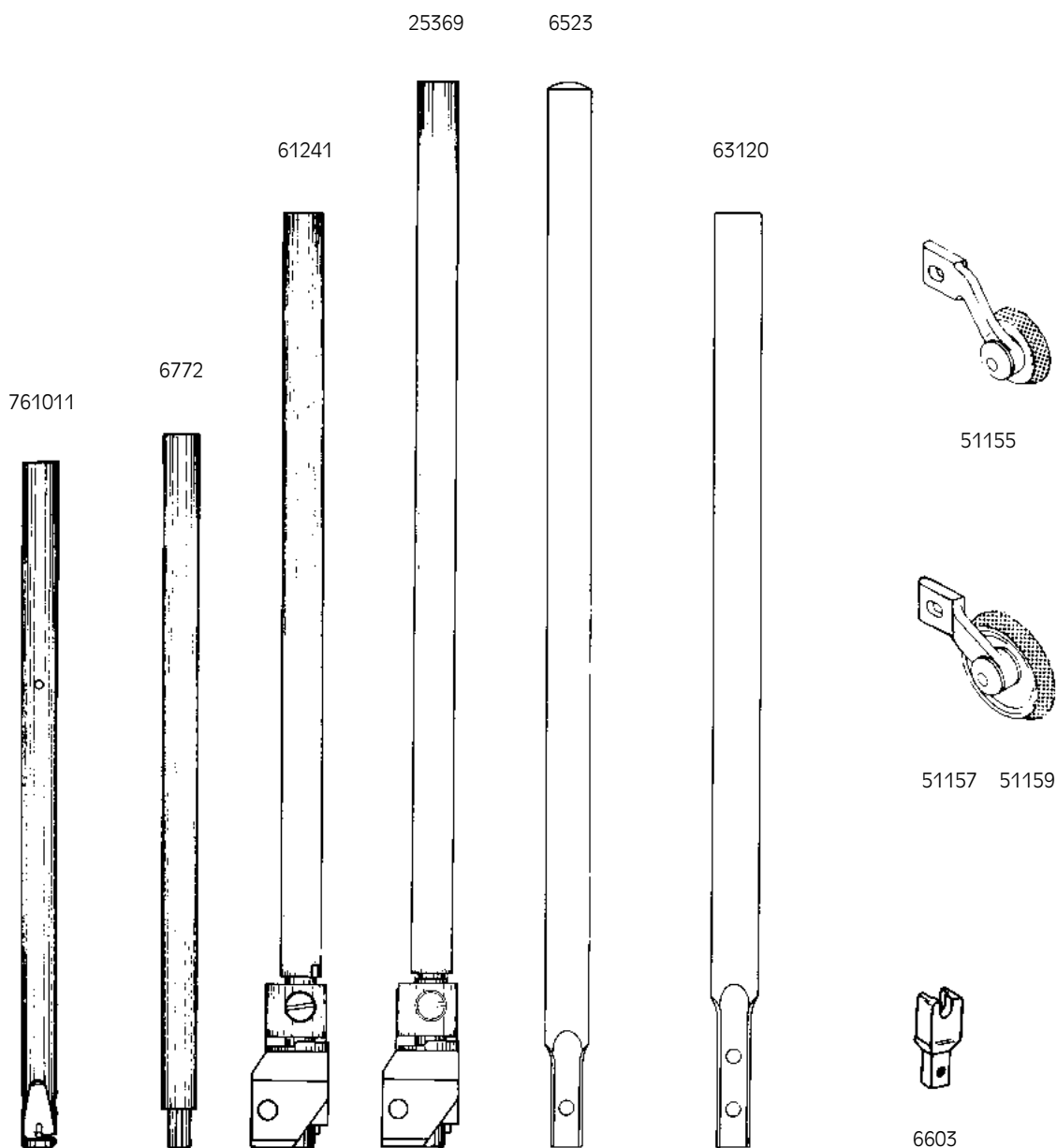

N. di catalogo N. di descrizione	N. originale	Descrizione articolo
761011	761011	Barra ago KL 234
6772	6772	Barra ago KL 24
61241 cpl	61241	Barra ago KL 234, completa di snodo
25369 cpl	25369	Barra ago KL 34/134, completa di snodo
6523	6523	Barra premistoffa KL 34
63120	63120	Barra premistoffa KL 234
51155	51155	Piedino a rulli ø 23
51157	51157	Piedino a rulli ø 32, h 3 mm.
51159	51159	Piedino a rulli ø 32, h 4,5 mm.
6603	6603	Prolunga per piedino



171076

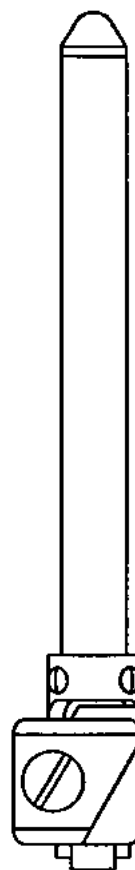

169318

N. di catalogo N. di descrizione	N. originale	Descrizione articolo
171076	171076	Barra premistoffa completa di snodo per KL 483
169318	169318	Barra premistoffa completa di snodo per KL 463

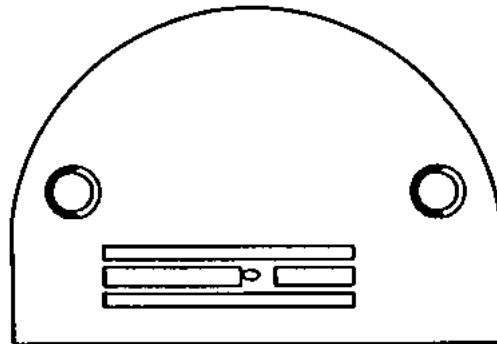

400006X1.2

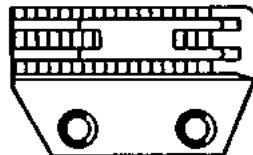

400005

N. di catalogo N. di descrizione	N. originale	Descrizione articolo
400006x1.2	400006X1.2	Placca Pfaff 463
400005	400005	Griffa Pfaff 463

Kl. 191

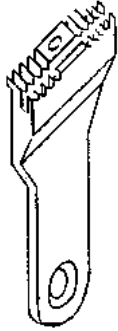

P45558 B
P45558 C

Kl. 191-4



P47061 B

Kl. 192



P40365 x 3.2 B
P40365 x 3.6 B
P40365 x 4.8 B
P40365 x 6.0 B
P40365 x 6.4 B



P48064 x 2.4/3.2
P48064 x 3.6/4.4
P48064 x 4.8/5.6
P48064 x 6.0/6.4

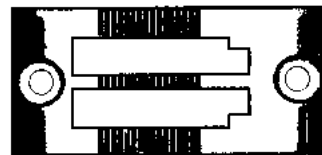
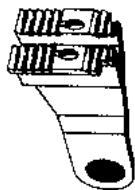

Kl. 193-4



46440

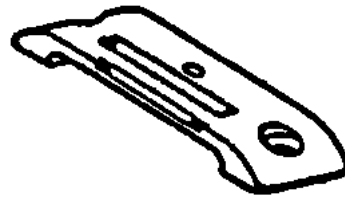

45600

Kl. 193-4D



P46441C



P46442C

Kl. 194, 294, 594

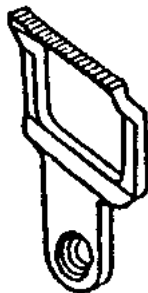

40358

- 40358 x 1,2
- P40358 x 1,6 B
- P40358 x 1,8 B
- P40358 x 2,0 B

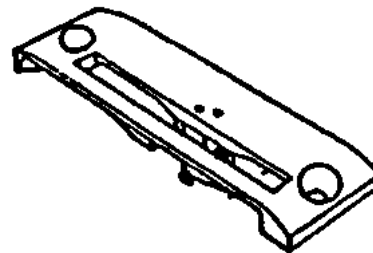

48068
48070

- 48068
x 1,2EX
- P48068 x 1,6 B
- P48068 x 1,8 B
- P48068 x 2,0 B
- P48068 x 2,4 B

RASAFILO

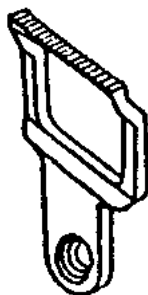

P59210

- P59210 x 1,6 B
- P59210 x 1,8 B
- P59210 x 2,0 B
- P59210 x 2,2 B
- P59210 x 2,4 B
- P59210 x 1,6 C
- P59210 x 1,8 C
- P59210 x 2,0 C
- P59210 x 2,2 C
- P59210 x 2,4 C

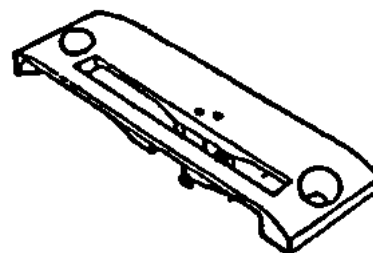

P158168
P158172

- P158168 x 1,2 B
- P158168 x 1,6 B
- P158168 x 1,8 B
- P158168 x 2,0 B
- P158172 x 1,6 B
- P158172 x 1,8 B
- P158172 x 2,0 B
- P158172 x 2,4 B

Kl. 1294

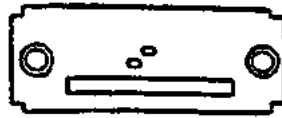

P58863 x 1,6C
 P58863 x 1,8C
 P58863 x 2,0C
 P58863 x 1,6D
 P58863 x 1,8D
 P58863 x 2,0D

P58863 = 58879

RASAFILO

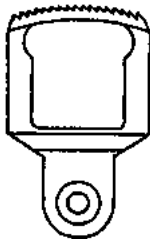

P59210 x 1,6B
 P59210 x 1,8B
 P59210 x 2,0B
 P59210 x 2,2B
 P59210 x 2,4B
 P59210 x 1,6C
 P59210 x 1,8C
 P59210 x 2,0C
 P59210 x 2,2C
 P59210 x 2,4C

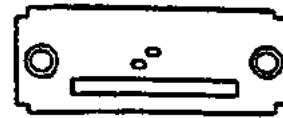

P158158 x 1,6B
 P158158 x 1,8B
 P158158 x 2,0B
 P158158 x 2,2B
 P158158 x 2,4B
 P158158 x 1,6C
 P158158 x 1,8C
 P158158 x 2,0C
 P158158 x 2,2C
 P158158 x 2,4C

Kl. 293



P59186B
 P59186C



P158225B
 P158225C

Kl. 1293



P45599A
 P45599B
 P45599C



P48321B
 P48321C
 P48321D

RASAFILO



P59186B
 P59186C

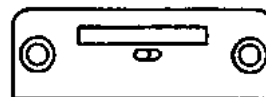

P158087C
 P158087D

Kl. 591

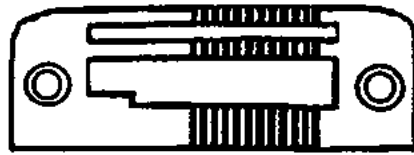

P48320

Kl. 331

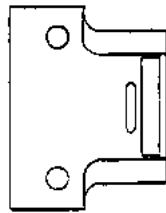

P48592 x 1,8 B

Kl. 438

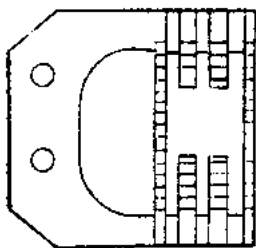

P47343 B

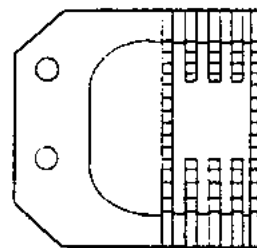

P47559 B

Kl. 474

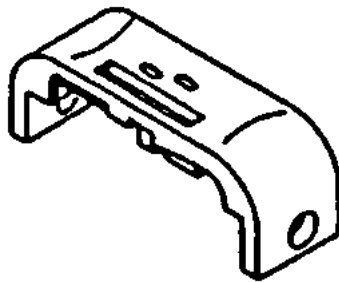

P58324 x 1,6B
P58324 x 1,8B
P58324 x 2,0B
P58324 x 2,2B
P58324 x 2,4B

P58324

Kl. 474 RASAFILO

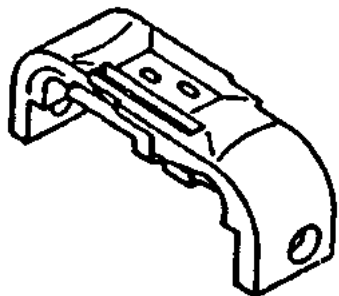

P58347 x 1,2B
P58347 x 1,6B
P58347 x 1,8B
P58347 x 2,0B
P58347 x 2,2B
P58347 x 2,4B

P58347

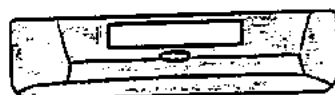
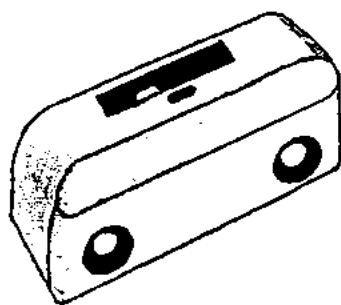

P58289 x 4,5 B

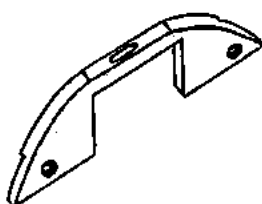

58499 x 1,2 B

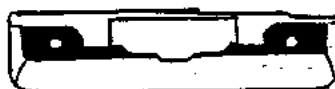
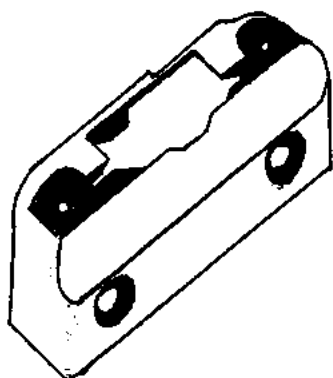

P58556



P150265 x 1,2 B
P150265 x 1,0 A

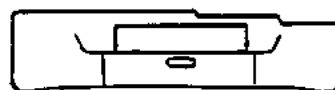
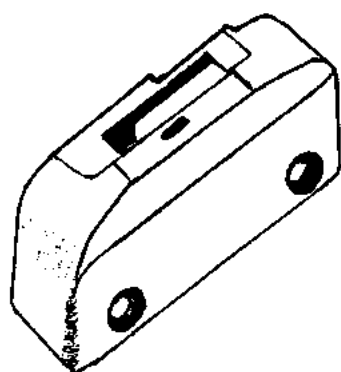

P150334B

N. di catalogo N. di descrizione	N. originale	Descrizione articolo
P58289 x 4,5 B		Placca ago KL. 471
58299 x 1,2 B		Inserto per KL. 471 Rasafilo (nuovo mod.)
P58556		Placca ago KL. 471 Rasafilo (nuovo mod.)
P150265 A - B		Inserto per KL. 471 Rasafilo (nuovo mod.)
P150334 B		Placca ago KL. 471 (nuovo mod.)
58288		Inserto per KL. 471 (vecchio mod.)

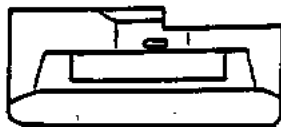
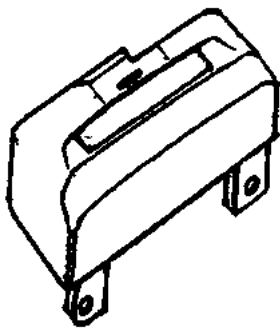

P158256 x 4,5 B
P158256 x 4,5 C

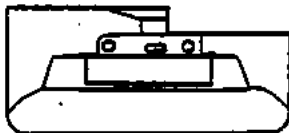
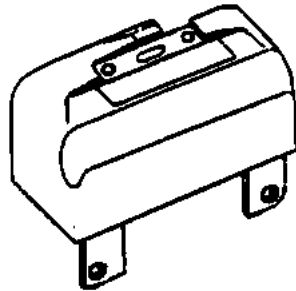

P150525B
P150525C



P150545B
P150545C

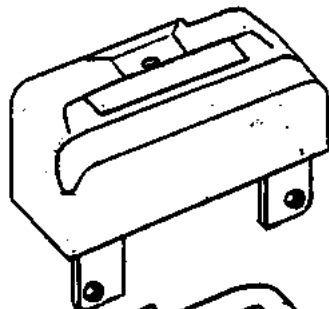

P58437B
P58437C

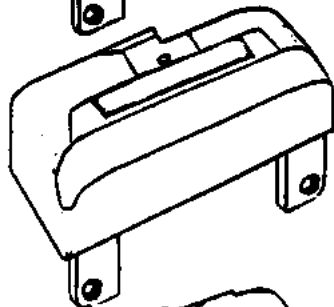

P158260B
P158260C

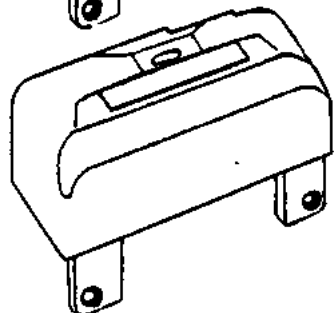

P58431C

N. di catalogo N. di descrizione	N. originale	Descrizione articolo
P158256 x 4,5 B - C		Placca ago per KL. Rasafilo (nuovo mod.)
P150525 B - C		Placca ago per KL. 491/493 (nuovo mod.)
P150545 B - C		Inserto per KL. 493 Rasafilo (nuovo mod.)
P58437 B - C		Placca ago per KL. 493 Rasafilo (vecchio mod.)
P158260 B - C		Placca ago per KL. 493 Rasafilo (nuovo mod.)
P58431 C		Placca ago per KL. 491 Rasafilo (vecchio mod.)

AGO SCHMETZ SIST. 34R 134R

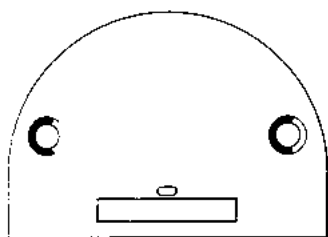

46397

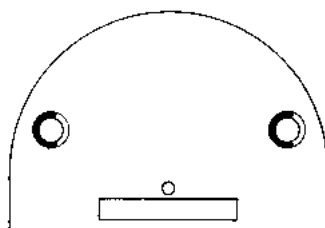

48673

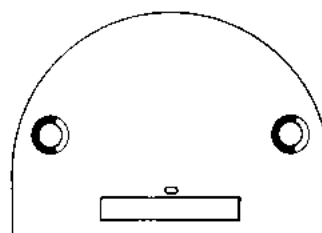

26275

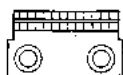

46398

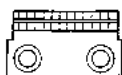

47260

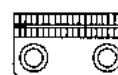

26270

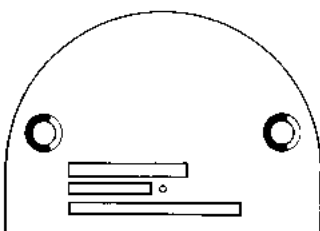

26096

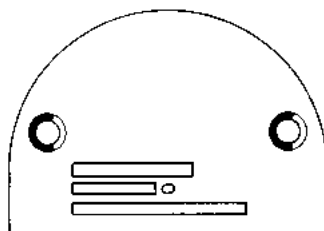

48517

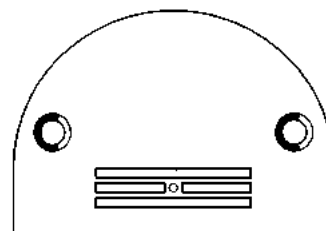

26209

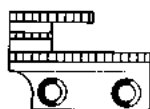

26095

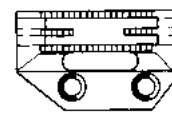

26208

N. di catalogo N. di descrizione	N. originale	Descrizione articolo
46397 B	46397 B	Placca ago cava media
46397 C	46397 C	Placca ago cava grande
46398 B	46398 B	Griffa, dentatura media
46398 C	46398 C	Griffa, dentatura grossa
48673 B - C	48673 B - C	Placca ago rasafilo KL 463 cava media o grande
47260 B - C	47260 B - C	Griffa, dentatura media o grande
26275	26275	Placca ago
26270	26270	Griffa
26096	26096	Placca ago
48517	48517	Placca ago
26095	26095	Griffa
26209	26209	Placca ago
26208	26208	Griffa

AGO SCHMETZ SIST. 34R 134R

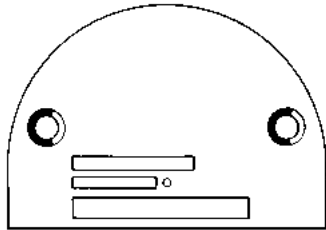

26272

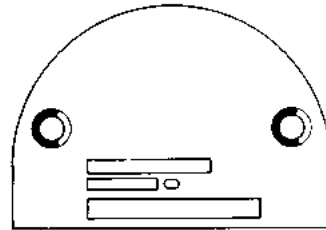

48519

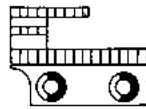

26271

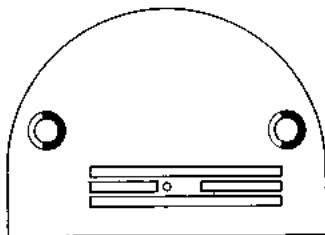

48664

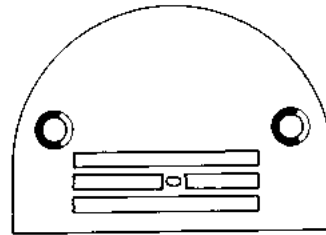

58048

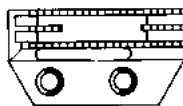

47298

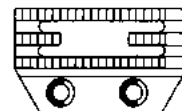

47547

N. di catalogo N. di descrizione	N. originale	Descrizione articolo
26272	26272	Placca ago
48519	48519	Placca ago
26271	26271	Griffa
48664	48664	Placca ago
47298	47298	Griffa
58048	58048	Placca ago
47547 B	47547 B	Griffa, dentatura media
47547 C	47547 C	Griffa, dentatura grossa

AGO SCHMETZ SIST. 134-35 130R 134R 438KK

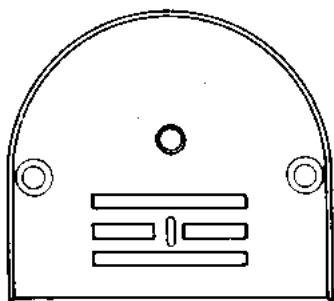

26512

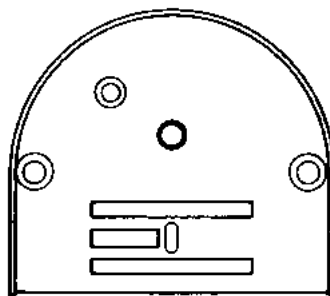

46313

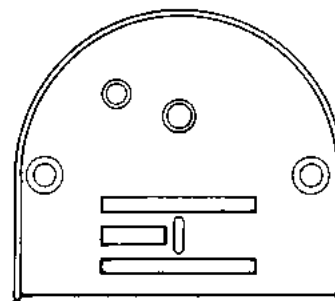

26888

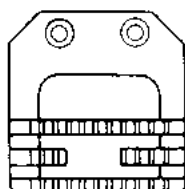

26511

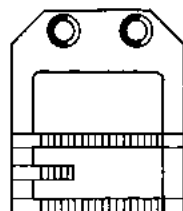

26883

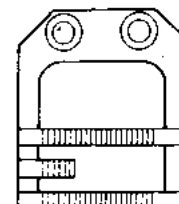

26891

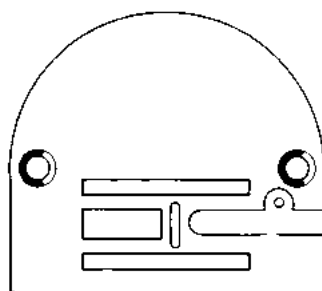

48532 C x 6

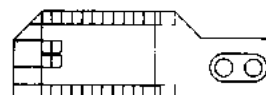

47060

N. di catalogo N. di descrizione	N. originale	Descrizione articolo
26512	26512	Placca ago
26511	26511	Griffa
46313	46313	Placca ago
26883	26883	Griffa
26888	26888	Placca ago per zig-zag 6 mm.
26891	26891	Griffa per zig-zag 6 mm.
48532 C x 6	48532 C x 6	Placca ago per mocassino
47060	47060	Griffa per mocassino

AGO SCHMETZ SIST. 134R

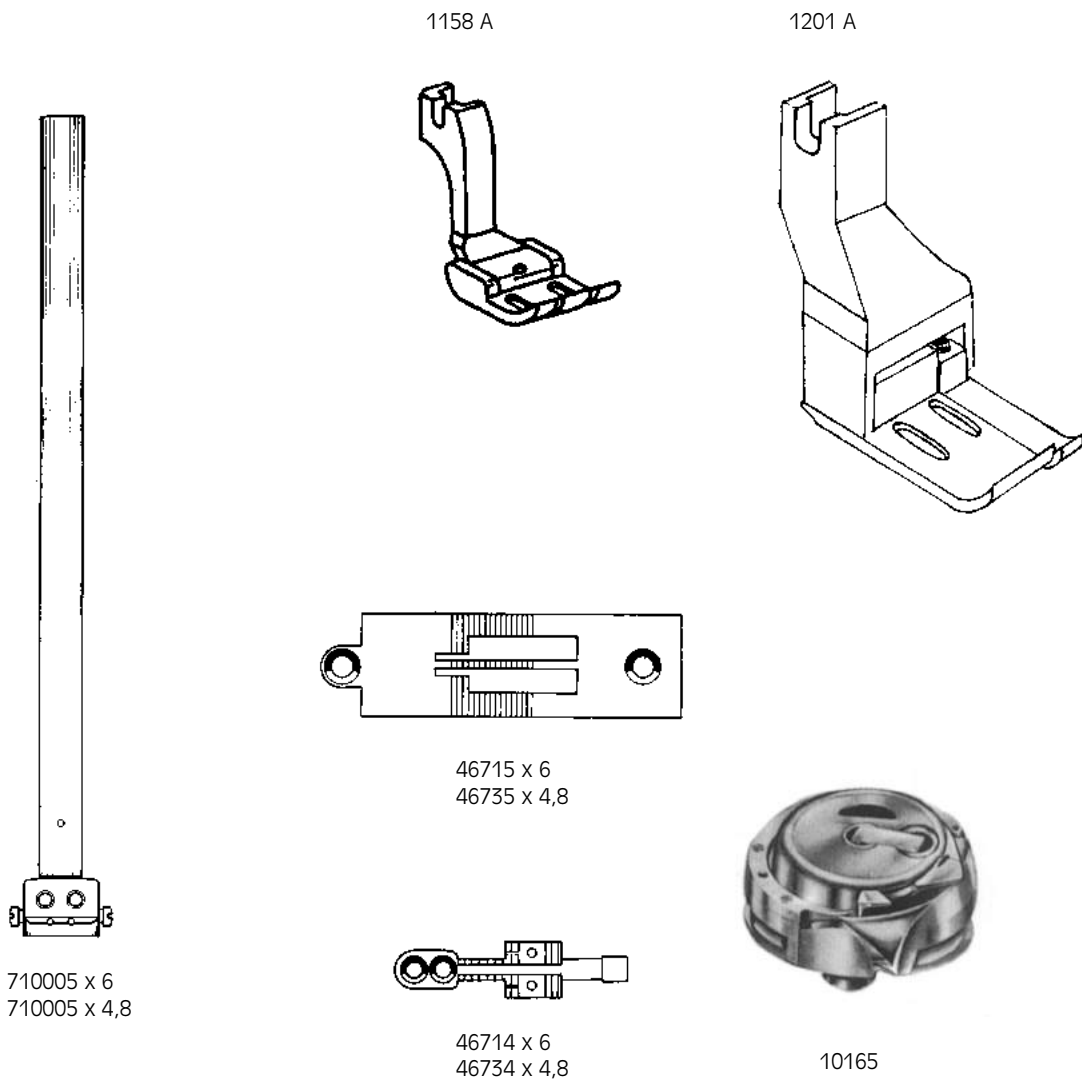

N. di catalogo N. di descrizione	N. originale	Descrizione articolo
710005 x 6 / 4,8	710005 x 6 / 4,8	Barra 2 aghi interasse 6 mm. / 4,8 mm.
1158 A x 4,8	1158 A x 4,8	Piedino 2 aghi interasse 4,8 mm.
1158 A x 6,4	1158 A x 6,4	Piedino 2 aghi interasse 6,4 mm.
1201 A x 4,8		Piedino compensatore destro 4,8 mm.
1201 A x 6,4		Piedino compensatore destro 6,4 mm.
1202 A x 4,8 DP		Piedino compensatore doppio 4,8 mm.
1202 A x 6,4 DP		Piedino compensatore doppio 6,4 mm.
46715 x 6	46715 x 6	Placca ago interasse 6 mm.
46714 x 6	46714 x 6	Griffa interasse 6 mm.
8278	10165	Crochet C.P.L.
10079	10079	Rocchettino in ferro
10079 A	10079 A	Rocchettino in alluminio
700868	700868	Vite barra ago

AGO SCHMETZ SIST. 134 35R

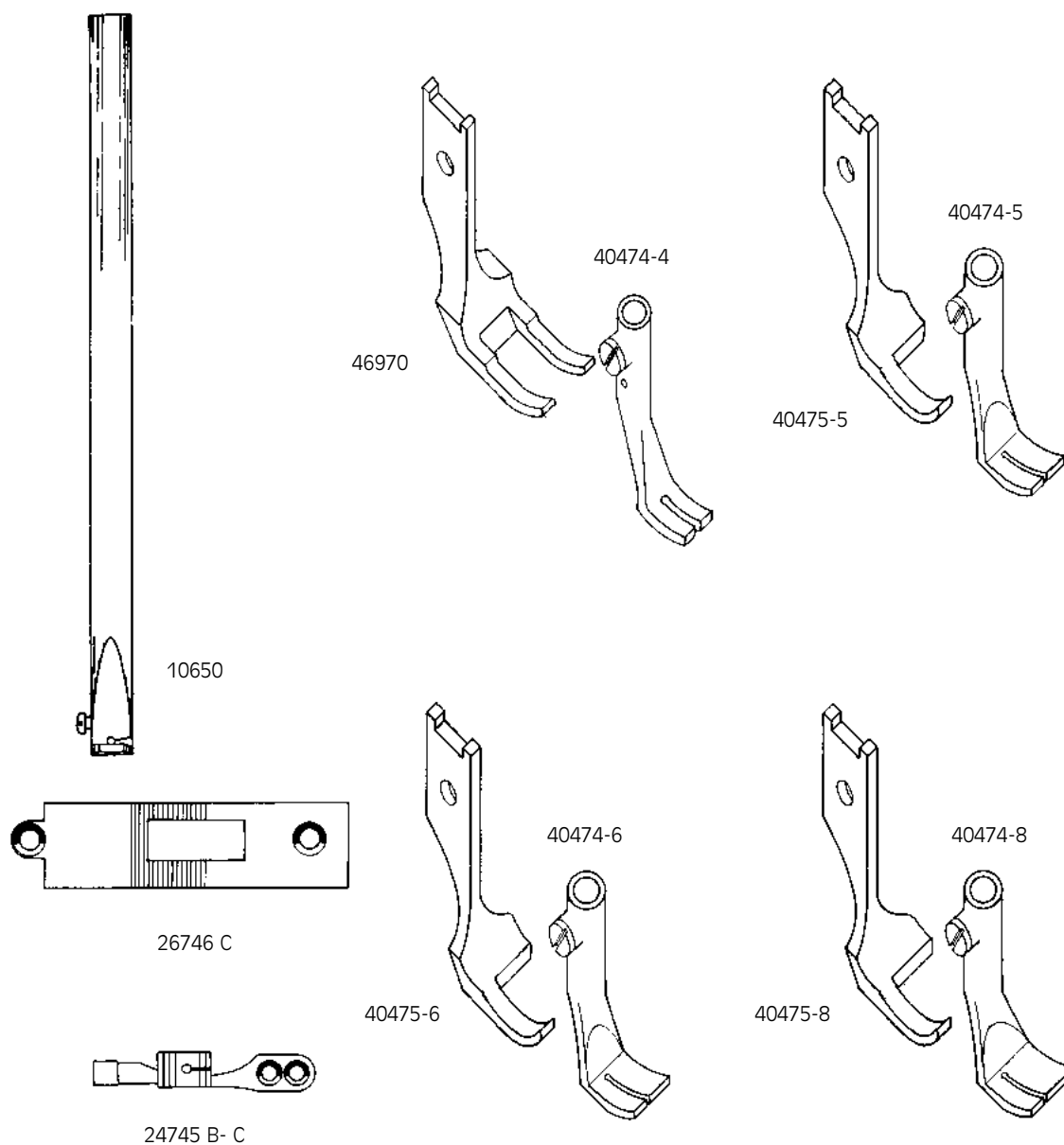

N. di catalogo N. di descrizione	N. originale	Descrizione articolo
10650	10650	Barra ago
26746 C	26746 C	Placca ago
26745 B	26745 B	Griffa foro medio
26745 C	26745 C	Griffa foro grande
40474-4	40474-4	Piedino anteriore
46970	46970	Piedino posteriore
40474-5	40474-5	Piedino anteriore
40475-5	40475-5	Piedino posteriore
40474-6	40474-6	Piedino anteriore
40475-6	40474-6	Piedino posteriore
40474-8	40474-8	Piedino anteriore
40475-8	40474-8	Piedino posteriore

AGO SCHMETZ SIST. 134-35R

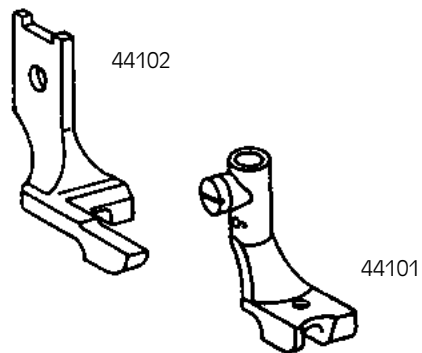
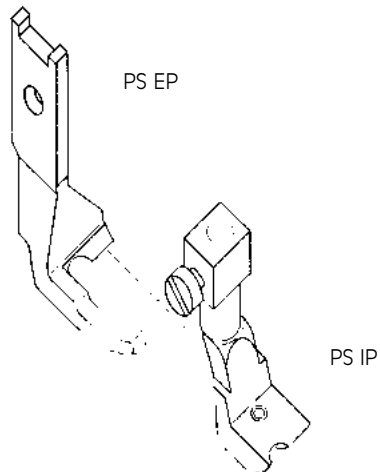
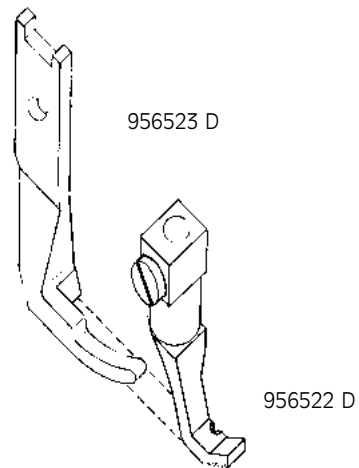
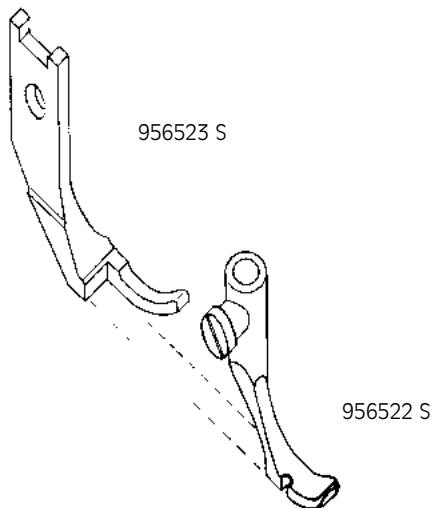

N. di catalogo N. di descrizione	N. originale	Descrizione articolo
956523 S	49558 C - D	Mezzo piedino posteriore sinistro
956522 S	49085 C	Mezzo piedino anteriore sinistro
956522 D		Mezzo piedino anteriore destro
956523 D		Mezzo piedino posteriore destro
PS IP (da 2 a 7)		Piedino scanalato interno (da 2 a 7)
PS EP (da 2 a 7)		Piedino scanalato esterno (da 2 a 7)
PSS IP (da 2 a 8)		Piedino scanalato sagomato interno (da 2 a 8)
PSS EP (da 2 a 8)		Piedino scanalato sagomato esterno (da 2 a 8)

AGO SCHMETZ SIST. 134-35R

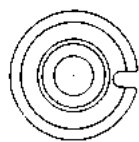

6505

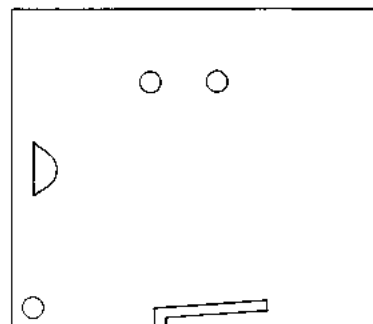

10061



44227



42819

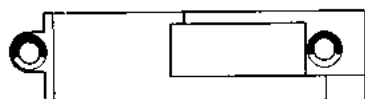

45592 C



45607

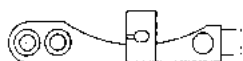

45591 C

N. di catalogo N. di descrizione	N. originale	Descrizione articolo
44227/40432	44227/40432	Piedino posteriore per bordare
42819	42819	Piedino anteriore per bordare
45592 C	45592 C	Placca ago per bordare
45591 C	45591 C	Griffa per bordare
6505	6505	Disco tensione
10061	10061	Placca scorrevole
45607	45607	Piastra per bordare

AGO SCHMETZ SIST. 134R

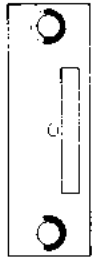

45600



48068 x 1,2



26532 x 1,2
P 26532 x 1,6B
P 26532 x 1,8B
P 26532 x 2,0B

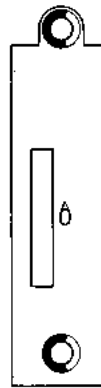

58678 C



26673 B

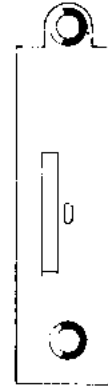

26725

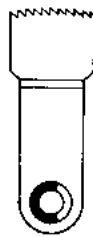

45440

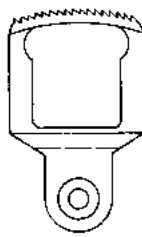

40358 x 1,2

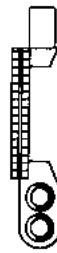

26531 x 1,2
P 26531 x 1,6B
P 26531 x 1,8B
P 26531 x 2,0B



40417



26672B

N. di catalogo N. di descrizione	N. originale	Descrizione articolo
45600	45600	Placca ago 193-944
46440	46440	Griffa 193-944
48068 x 1,2	48068 x 1,2	Placca ago 194-4
40358 x 1,2	40358 x 1,2	Griffa 194-4
26532 x 1,2/1,6/1,8/2,0	26532 x 1,2/1,6/1,8/2,0	Placca ago 144
26531 x 1,2/1,6/1,8/2,0	26531 x 1,2/1,6/1,8/2,0	Griffa 144
58678 C	58678 C	Placca ago 141
40417	40417	Griffa 141
26673 B	26673 B	Placca ago 141
26672 B	26672 B	Griffa 141
26725	26725	Placca ago 141

KIT 335 PER BORDARE



40432



40629



46497

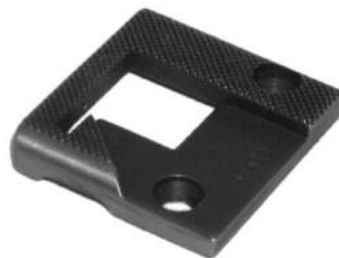

46498

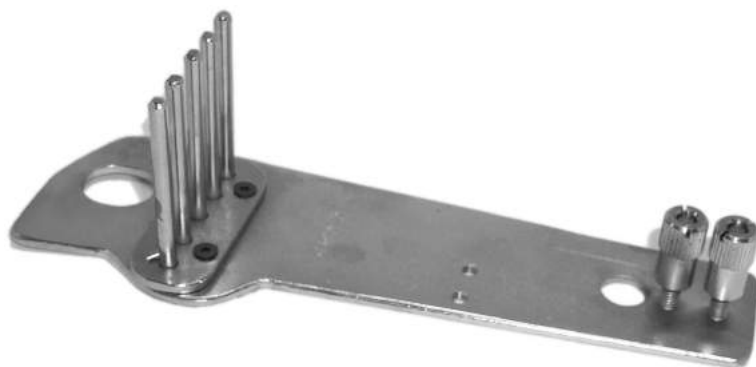

40894

N. di catalogo N. di descrizione	N. originale	Descrizione articolo
40432	40432/44227	Piedino posteriore per bordare
40629	40629	Piedino anteriore per bordare
46497	46497	Griffa
46498	46498	Placca
40894	40894	Piastra CPL per bordare

AGO SCHMETZ SIST. 134-35R

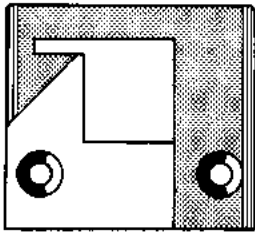

46498

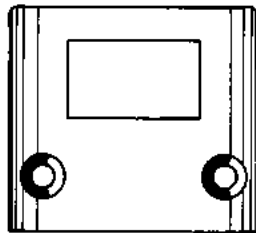

46009

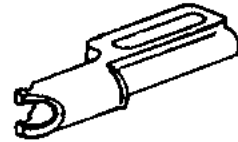

40452



46497

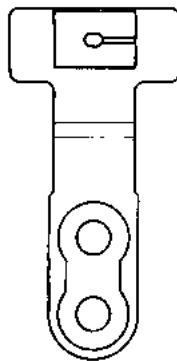

46008



105490

N. di catalogo N. di descrizione	N. originale	Descrizione articolo
46008	46008	Griffa per 335-6
46009	46009	Placca per 335-6
46497	46497	Griffa per 335-17
46498	46498	Placca per 335-17
2021 A misura da 9 a 25 mm.	40452	Beccuccio bordatore per 335-17 Specificare misure e spessore
8520 C	105490	Crochet 335 C.P.L.

AGO SCHMETZ SIST. 134R

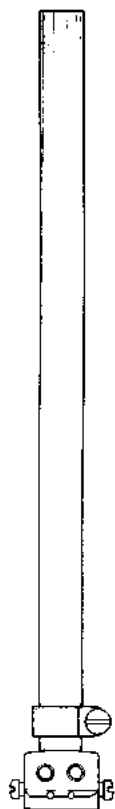

140097 x 6

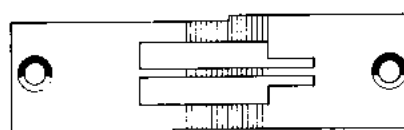

58108 x 6



47574 x 6

N. di catalogo N. di descrizione	N. originale	Descrizione articolo
140097 x 6	140097 x 6	Barra 2 aghi interasse mm. 6
58108 x 6	58108 x 6	Placca 2 aghi interasse mm. 6
47574 x 6	47574 x 6	Griffa 2 aghi interasse mm. 6

AGO SCHMETZ SIST. 134R

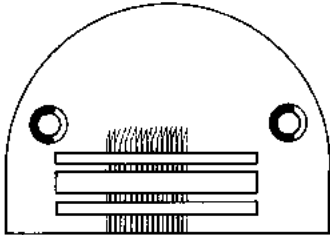

58355

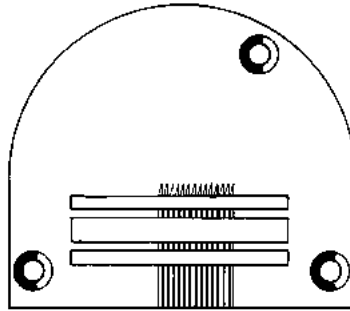

58579

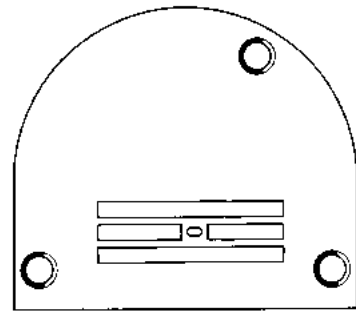

58132



47750 B

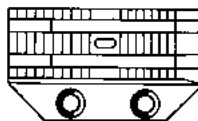

47867 C

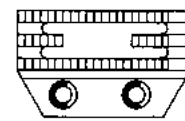

47547

N. di catalogo N. di descrizione	N. originale	Descrizione articolo
58355	58355	Placca ago 461
47750 B	47750 B	Griffa 461
58579	58579	Placca ago 481
47867 C	47867 C	Griffa 481
58132	58132	Placca ago 483
47547 B	47547 B	Griffa 483 dentatura media
47547 C	47547 C	Griffa 483 dentatura grossa

Kl. 42, 31

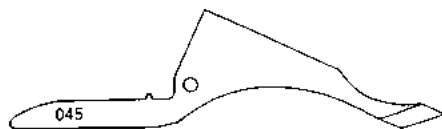

3615 M
P 12 x N 1
40-0012-2-045 HSS



3615 M SP
P 12 x N 1-SP HSS
40-0012-0-000

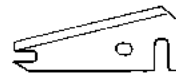

3616 M
P 127
40-0017-2-000

Kl. S 2



3621 M
S 2-51 R
20-0051-1-024



3622 M
S 2-51 M



3623 M
S 2-51 N



3626 M
S 2-51



3624 M
S 119-N
20-0119-2-000



3625 M
S 116-N 2
20-0116-3-000

PER ASOLE



3627 M
mm 3-6-9-11



3628 M
mm 12-14-16-19



3629 M
mm 22-25

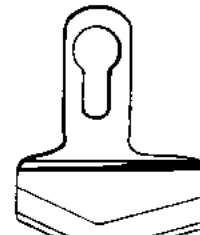

3630 M
mm 28-31-37

Kl. 101



3636 M
D 4
10-4004



3641 M
D 4 USA
10-4004 USA



3637 M
D 5
10-4005



3642 M
D 5 USA
10-4005 USA

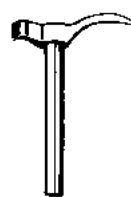

3638 M
D 8
10-4008

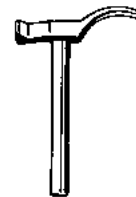

3639 M
D 9
10-4009

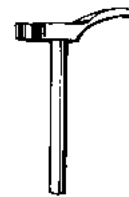

3643 M
D 9 USA
10-4009 USA

Kl. 27, 28, 29 Kl. 227, 228, 229 Kl. 327, 328, 329 Kl. 527, 529 Kl. 627, 629
Kl. 027 Stella



3661 M
270-112
202 142-0-10
CT=
207 000-2-00



3679 M
270-112/1
202 143-0-10
CT=
207 008-2-00
scanalato

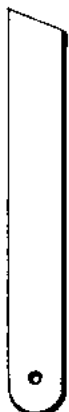

3662 M
270-113
202 145-0-10
CT=
207 018-2-00



3663 M
270-113/1
202 146-0-10
CT=
207 015-2-00



3664 M
2701-P 9 113/1
203 144-0-10
CT=
207 024-2-00



3680 M
209 593-0-00



3665 M
277-112
203 010-0-10
CT=
207 002-2-00
scanalato



3666 M
276-B-112
202 932-0-10
CT=
207 001-2-00



3667 M
277-113
203 012-0-10
CT=
207 016-2-00



3671 M
279-112
203 066-0-10
CT=
207 006-2-00

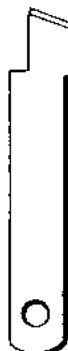

3672 M
279-113
203 068-0-10
CT=
203 068-0-10



3673 M
279-113/1
203 069-0-10
CT=
207 017-2-00



3683 M
202194-0-11

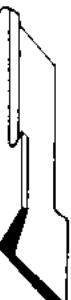

3674 M
2777-1121
203 783-0-10
CT=
207 003-2-00



3675 M
2777-112
203 759-0-10
CT=
207 004-2-00
scanalato



3677 M
290-113
204 693-0-11
CT=
207 020-2-01



3678 M
203 510-0-10



3681 M
920 780-0-10



3682 M
207 651

Kl. 27, 28, 29 Kl. 227, 228, 229 Kl. 327, 328, 329 Kl. 527, 529 Kl. 627, 629



3720 M
208 011-0-01



3721 M
206 208-0-00



3722 M
206 209-0-00



3690 M
27.277-074
204 021-0-10



3691 M
27.277-0745
204 033-0-10

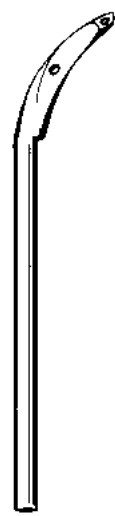

3723 M
204 022-0-10

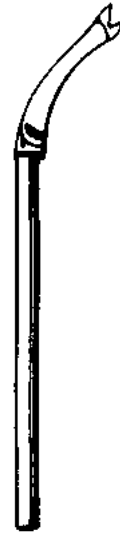

3694 M
270-D-074-1
202 092-0-10
202 092-0-11



3724 M
206 512-0-02



3692 M
277-074
203 005-0-10



3693 M
2777-074
203 755-0-10
207 208-0-00



3685 M
270-074
202 090-0-10



3686 M
270-074/2
202 093-0-10

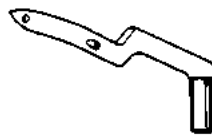

3697 M
209 248-0-00

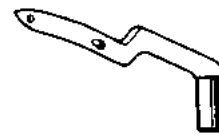

2698 M
209 249-0-00



3699 M
209 247-0-00

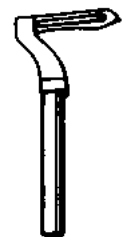

3696 M
209-075/2
204 676-0-11

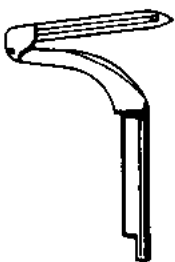

3725 M
209 264-0-00

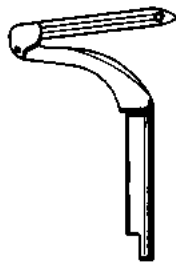

3726 M
209 265-0-00



3727 M
207 722-0-00
207 722-0-01

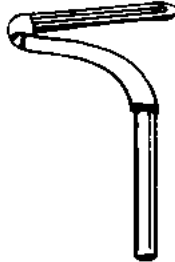

3687 M
207-075
202 094-0-11

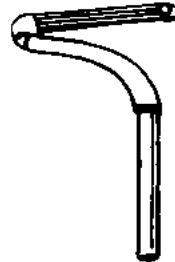

3688 M
207-075/2
202 095-0-11

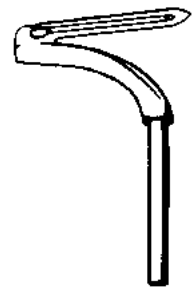

3689 M
207-0751
202 413-0-11

KI. 27, 28, 29 KI. 227, 228, 229 KI. 327, 328, 329 KI. 527, 529 KI. 627, 629

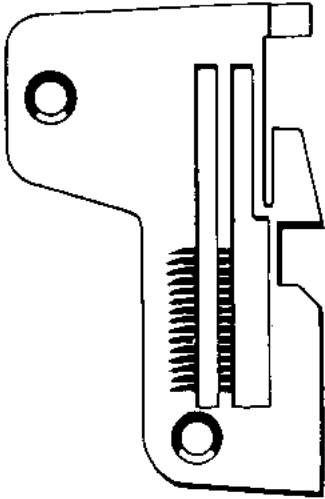

4636 M
202 508-0-10

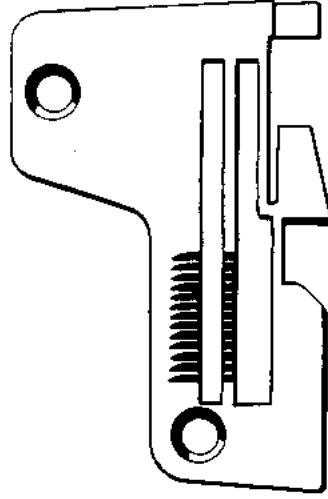

4637 M
202 590-0-10

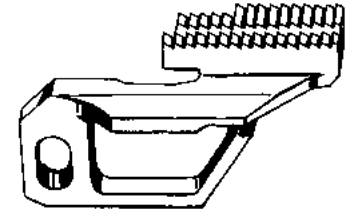

4638 M
202 053-0-10



4639 M
202 057-0-10



4640 M
202 061-0-10

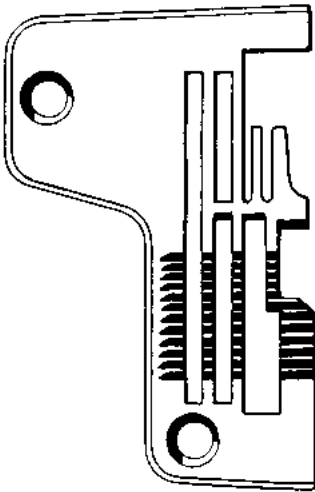

4641 M
203 578-0-10

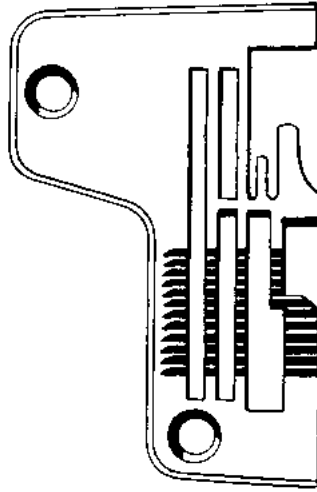

3704 M
27-277-114
204 026-0-10

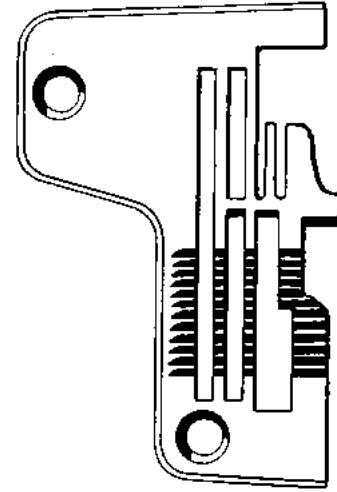

4642 M
27-26-114
203 547-0-10

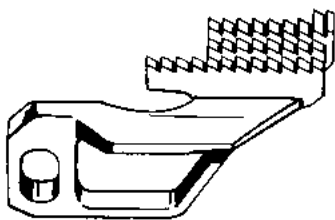

4643 M
206 298-0-10



4644 M
203 609-0-10



4645 M
203 612-0-10

Kl. 183

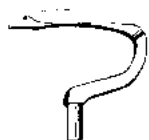

3658 M
350 145-0-10

Kl. 21 und 24 Stella Kl. 25 und 26 Stella

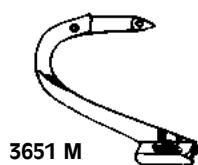

3651 M
1074
200 172-0-10



3652 M
1075
200 178-0-10



3653 M
1112
200 271-0-10



3654 M
1113
200 274-0-10



3655 M
2112
200 403-0-10



3656 M
2113
200 404-0-10

Kl. 63, 64, 65, 261, 262, 263, 264

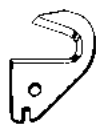

3710 M
303 012-0-10



3711 M
63 78-112
302 807-0-10
CT=305 671-2-00
con vidia



3712 M
63 78-113
302 808-0-10
CT=305 670-2-00
con vidia



3715 M
306 223-0-10
con vidia
306 286



3716 M
306 224-0-10
con vidia
306 285



3717 M
306 234-0-00
con vidia
306 284



3718 M
306 235-0-00
con vidia
306 283



3713 M
633-075/2
302 057-0-11
302 057-0-12

Kl. 27, 28, 29 Kl. 227, 228, 229 Kl. 327, 328, 329 Kl. 527, 529 Kl. 627,629

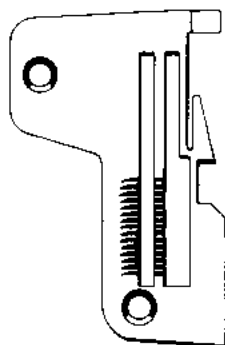

3702 M
270-1141
202 504-0-10

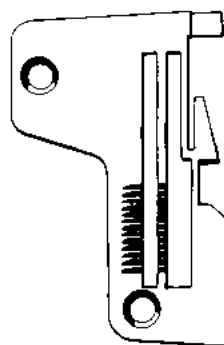

3701 M
270-114
202 148-0-10

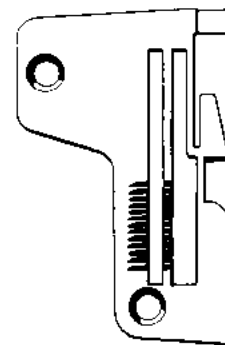

4635 M
202 507-0-10

Kl. 27, 28, 29 Kl. 227, 228, 229 Kl. 327, 328, 329 Kl. 527, 529 Kl. 627, 629

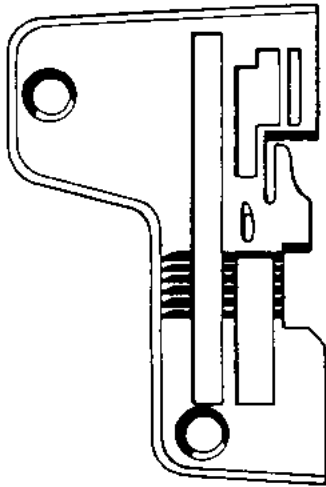

3706 M
290-114/1
204 695-0-11

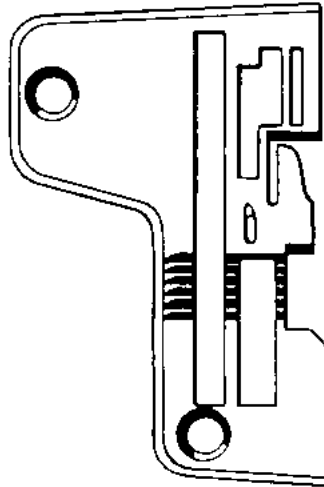

4646 M
204 696-0-10

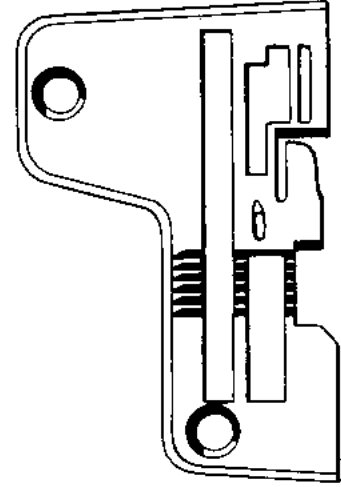

4647 M
204 809-0-00

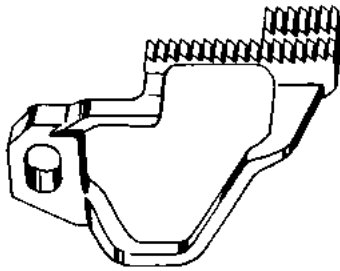

4648 M
204 666-0-10



4649 M
204 668-0-10



4650 M
202 609-0-10

Kl. 427, 429



4215 M
KR 35
= 202 295



4208 M
KR 23
= 201 121 A
con vicia

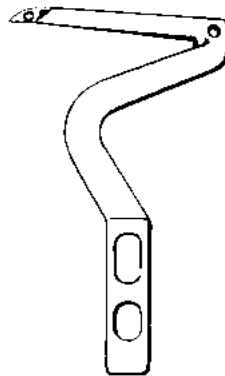

4606 M
KL 25
= 210 356

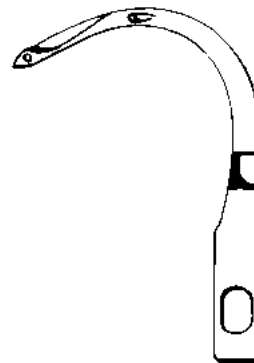

4607 M
KM 04
= 210 357



4608 M
LP 22
= 210 364



4609 M
LP 24
= 210 365



4610 M
LP 26
= 210 366

Kl. 51 W 55

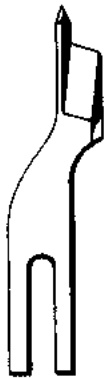

3737 M
241572



3738 M
241574



3739 M
241575



3740 M
241578

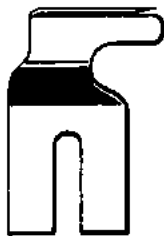

3758 M
8061 A-2,4
8061 A-2,7
8061 A-3,1
8061 A-3,5

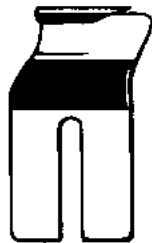

3759 M
249191



3760 M
263735

Kl. 51 W 59

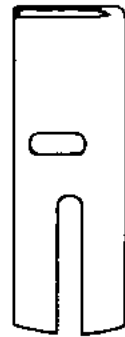

3745 M
238508

Kl. 71

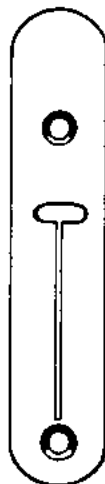

3821 M
39608
Kl. 71-30

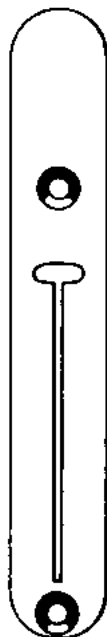

3822 M
39726
Kl. 71-32



3823 M
249851
Kl. 71-103



3824 M
23492
Kl. 71

Kl. 52 / PRAZAK



3775 M
13617

Kl. 71



3781 M
40048
Kl. 71-30



3782 M
39609
Kl. 71-30



3783 M
39867
Kl. 71-48/71-112



3784 M
39858
Kl. 71-48/71-112

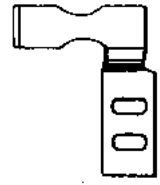

3785 M
40035

Kl. 71
Kl. 71—48
Kl. 71—30
Kl. 271
Kl. 39 900

PER ASOLE



3791 M
mm 6-8-9-11

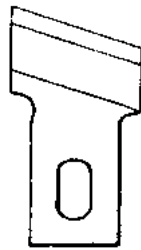

3792 M
mm 12-14-16
17-19

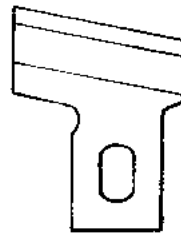

3793 M
mm 20-22-24-25

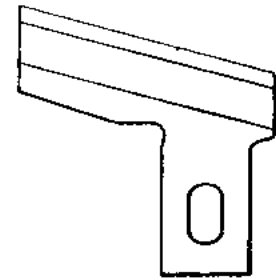

3794 M
mm 28-31

Kl. 96, 451 K 11



3831 M
127026*



3862 M
127027*



3863 M
147211
276489
con vidia



3864 M
147495
con vidia



3865 M
5730
142032
52131*
1/8" - 1/4"



3866 M
147262
1/8" - 1/4"
con vidia

La Maggior parte dei
coltelli è anche disponibile
con vidia

Kl. 81



3831 M
42033*



3832 M
42111*



3833 M
42213*



3834 M
42046*



3835 M
42305*



3836 M
42309*

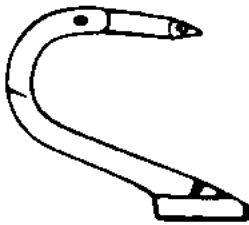

3841 M
42166

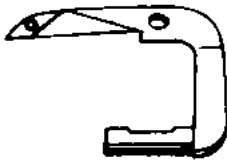

3842 M
42114

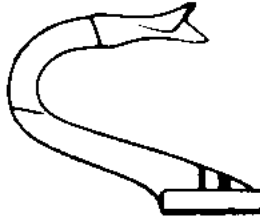

3843 M
132631
42072

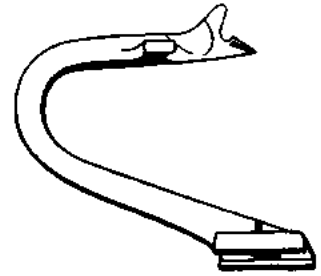

3844 M
42250

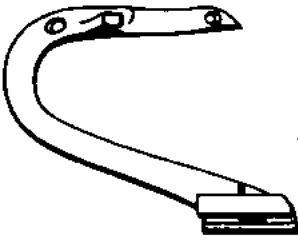

3845 M
42220

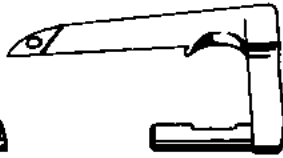

3846 M
42219

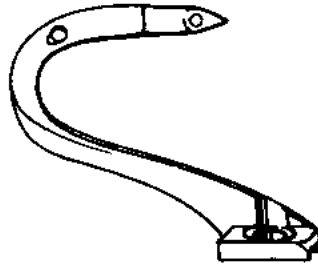

3847 M
42239

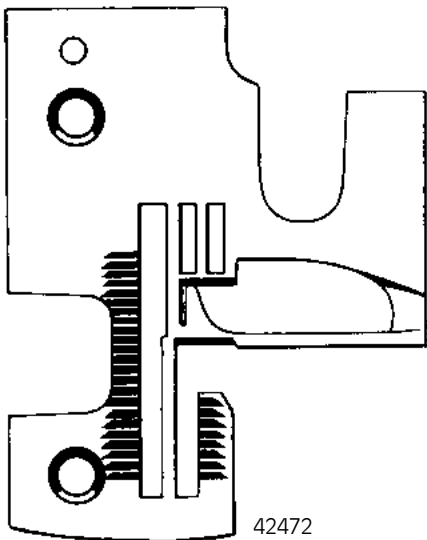

3851 M

42472

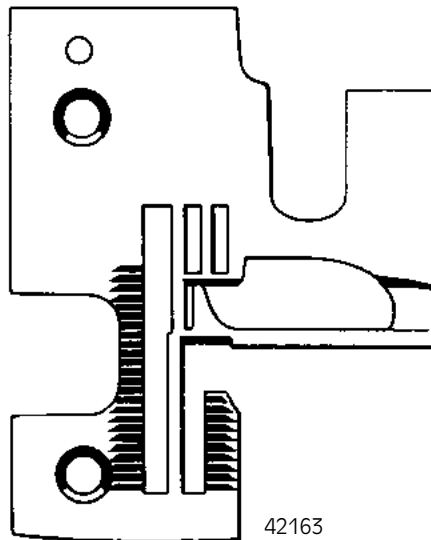

3852 M

42163

Kl. 175



3885 M
175085



3886 M
175547

Kl. 231

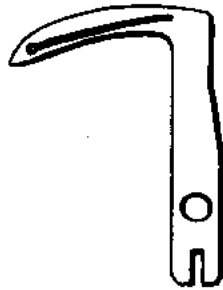

3891 M
139288
 $\frac{1}{4}'' + \frac{1}{8}''$

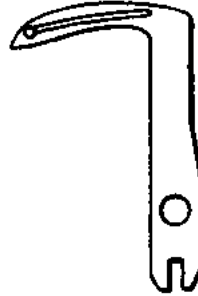

3892 M
139338 e 139056
 $\frac{1}{4}'' + \frac{1}{8}''$

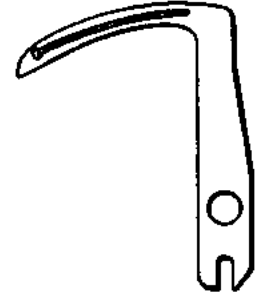

3893 M
139339 e 139057
 $\frac{1}{4}'' + \frac{1}{8}''$

Kl. 246 K, 460, 990



3901 M
164308*



3902 M
164550*



3903 M
164026*



3904 M
164556*
scanalato



3905 M
82264*
scanalato



3906 M
107 797*



3907 M
164037*



3908 M
164 233*
164 552*
164 728*



3909 M
164809
con vicia

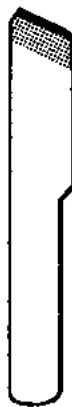

3910 M
164813
con vicia

Kl. 246 K, 460, 990

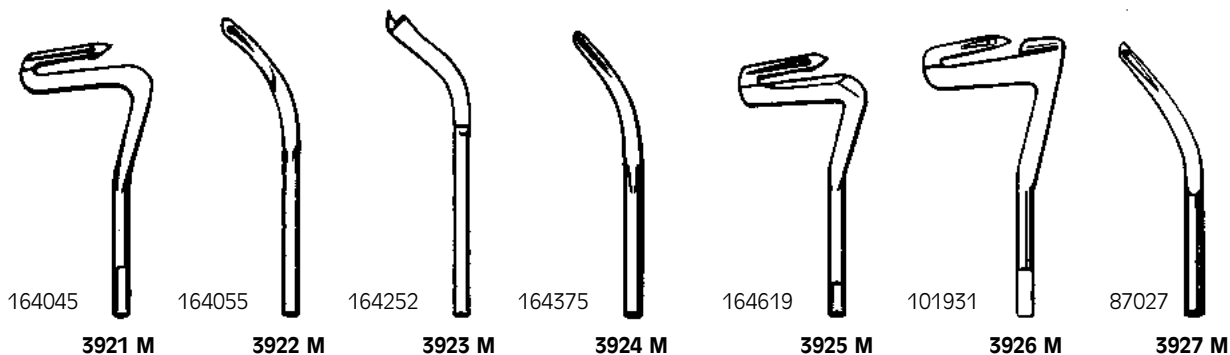

Kl. 269

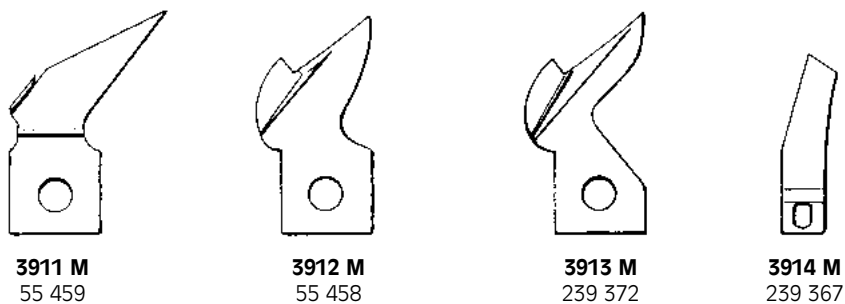

Kl. 281

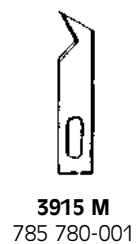

Kl. 369

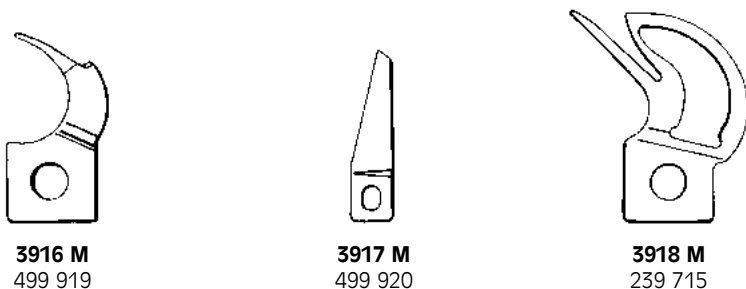

Kl. 300 W

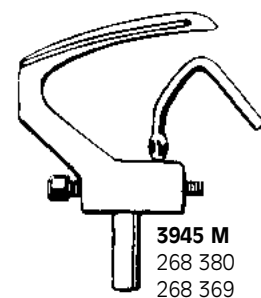

Kl. 400 W 11

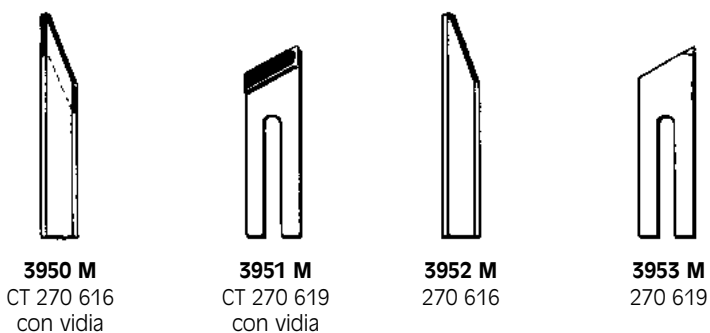

Kl. 451 und 600 Mansew



Kl. 111 W 116

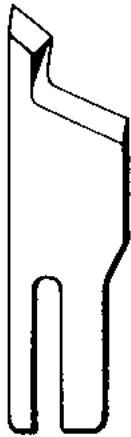

3876 M
240460

Kl. 111 W 141



3879 M
240449

Kl. 700



3965 M
S 36*

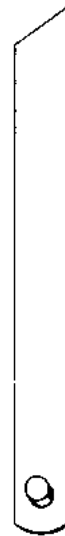

3966 M
S 150*

Kl. 660 AX 2

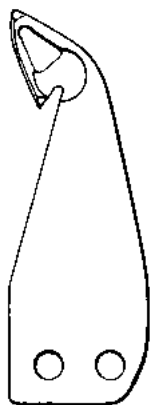

3970 M
GU 3605

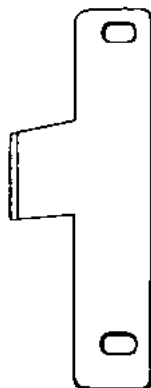

3971 M
GU 3606

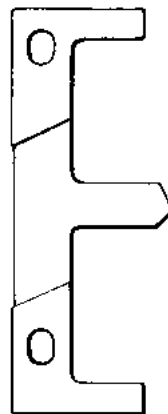

3972 M
107 519

ATTENZIONE: Il presente Catalogo non contempla tutti gli articoli disponibili in magazzino, ma è limitato a quelli di maggior consumo.

Si prega pertanto, per eventuali ordini di pezzi non illustrati, di indicare il loro numero originale e la classe della macchina, o inviare campioni.

KL 727, 737, 747, 757 = RIMOLDI 427-429



4215 M
KR 35
= 202 295



4208 MV
KR 23
= 201 121 A
con vicia

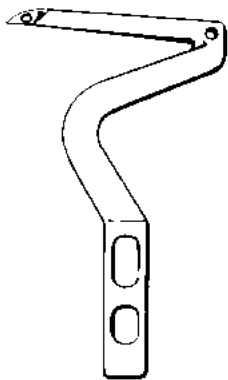

4606 M
KL 25
= 210 356

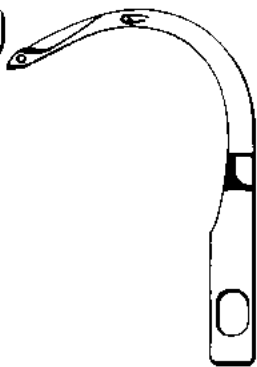

4607 M
KM 04
= 210 357



4608 M
LP 22
= 210 364



4609 M
LP 24
= 210 365



4610 M
LP 26
= 210 366

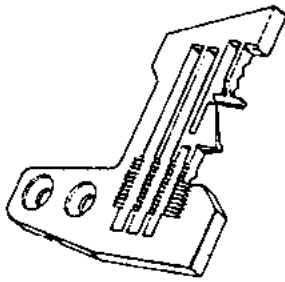

E800 mm 4
210800

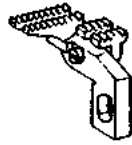

D575
210575

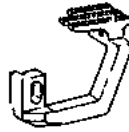

H445
210445



D996
210996

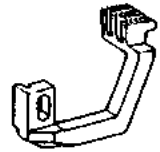

H959
210959

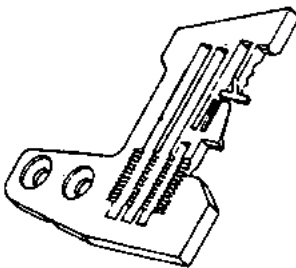

E809
210809

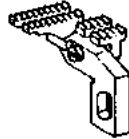

D575
210575

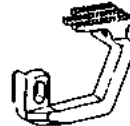

H445
210445

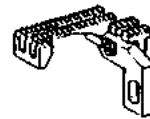

D996
210996

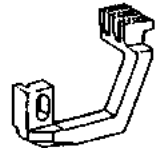

H959
210959

E810
210810

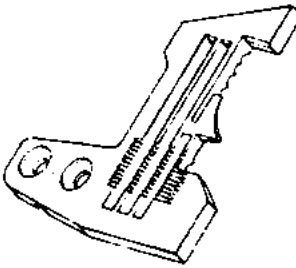

E796 mm 4
210796

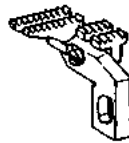

D574
210574

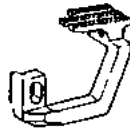

H445
210445

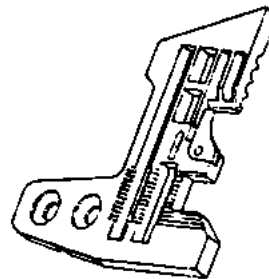

E834
210834

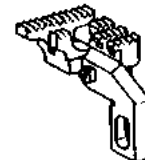

D579
210579

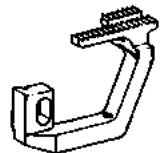

H492
210492

E797
210797

E839
210839

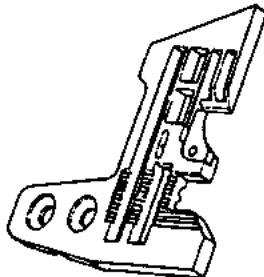

E853
210853

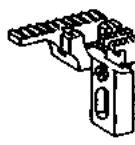

D582
210582

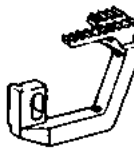

H495
210495

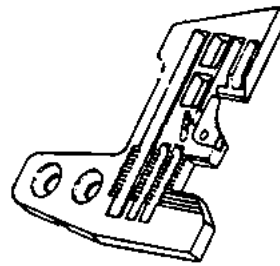

E981
210981

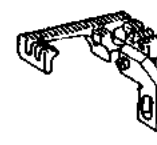

D002
210002

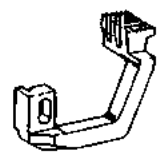

H957
210957

E854
210854

E982
210982

Kl. 15400



3981 M
15470*



3982 M
15449*



3984 M
15408 A



3985 M
15408 G



3986 M
15460

Kl. 33 700

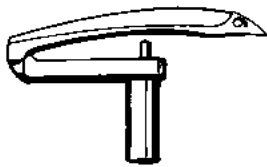

4655 M
33 709 C

Kl. 34 700



4656 M
34 749



4657 M
34 770

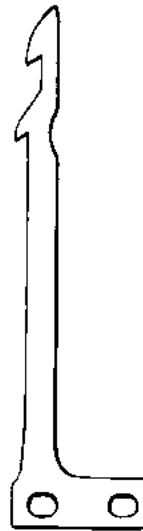

4658 M
34 749 K



4659 M
34 770 K

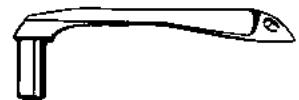

4660 M
34 709 (UR)

Kl. 35800

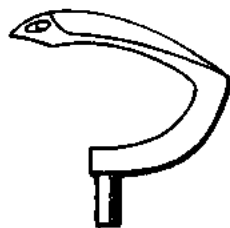

3991 M
AV = 35809 AY

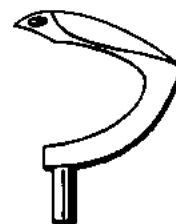

3992 M
AV = 35808 AY



3993 M
AV = 35809 BY

Kl. 36 200 Flatseamer



3997 M
36 270
CT 36 270

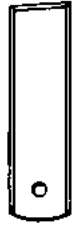

3998 M
36 250
CT 36 250



3999 M
36240



4661 M
36 251 E (A)

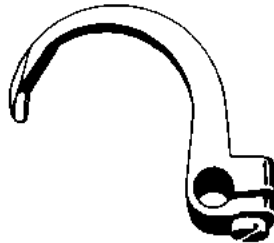

4662 M
36251 F



4000 M
36 208 A



4663 M
G 36 208 A

Kl. 39 200

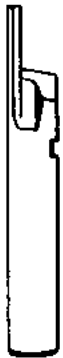

4005 M
39270*



4006 M
39270 A*



4007 M
39270 D*



4008 M
39270 J*



4009 M
39270 E*
Kl. 39 200/39 600



4010 M
39270 K*

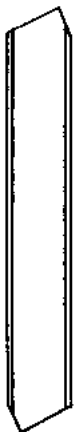

4011 M
39249 A*

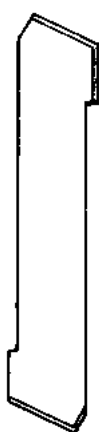

4012 M
39249 J*



4013 M
39249*



4014 M
39149*



4015 M
39249 K*

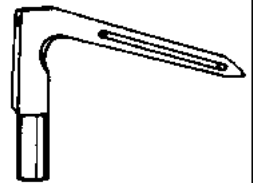

4020 M
39208 AA

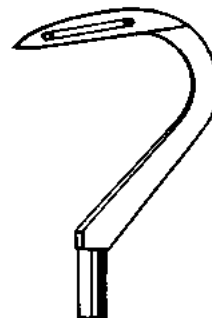

4021 M
39208 B*

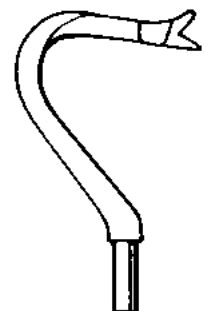

4022 M
39160

KI. 39500



4035 M
G 39570*



4036 M
G 39570 A*
(A 9181)*



4037 M
G 39570 JU*
(A 9259)*



4038 M
39570 J*



4039 M
39570 J*
scanalato



4040 M
A 9392 = 39570
con vicia

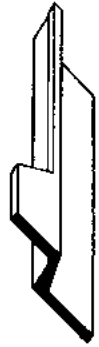

4041 M
39570 L

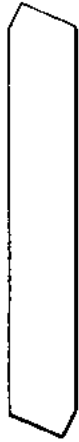

4044 M
39549*

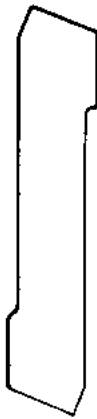

4045 M
39549 J*



4046 M
G 39549 JU*
(A 9071)



4047 M
G 39549 SU
con vicia

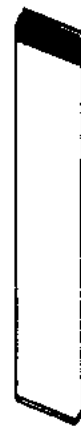

4048 M
G 39549 N
(A 9393)
con vicia



4049 M
99 669 (GC)

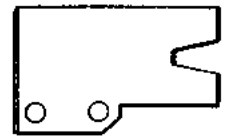

4050 M
99 670 (GD)



4056 M
39508 B



4057 M
39508 A (CC)
G 39508 A (UM)



4058 M
G 39508 AV (GC)
(A 9050)

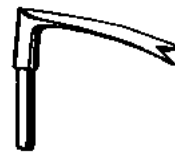

4059 M
39560 A

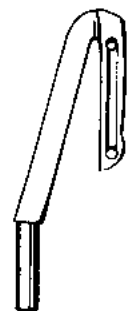

4051 M
39508 D



4052 M
39560 B

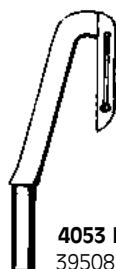

4053 M
39508 P

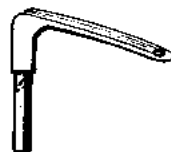

4054 M
39508 E (CK)

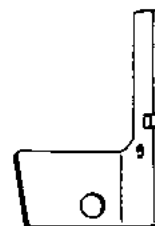

4042 M
99669 K (GM)

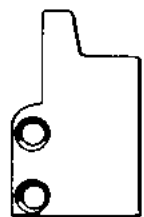

4043 M
99670 L

KI. 39200

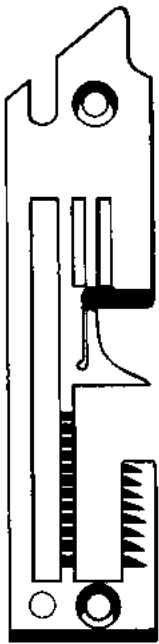

4026 M
39224 AC 3/32

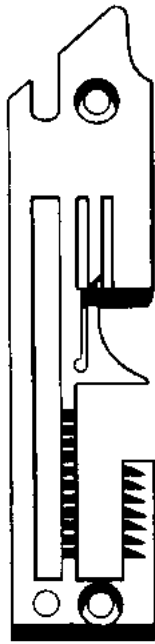

4027 M
39224 AC 1/8



4028 M
39224 J



4029 M
39224 AA



4030 M
39224 B

KI. 39800

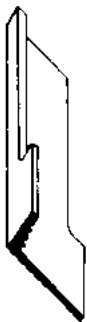

4661 M
39870

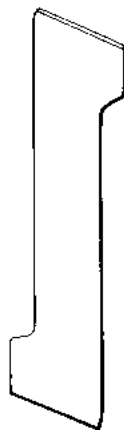

4662 M
39849
CT 39849

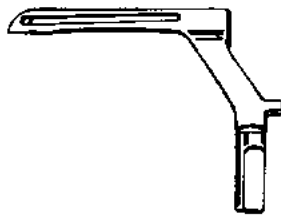

4663 M
39808 CY



4664 M
39808 D (ACZ)

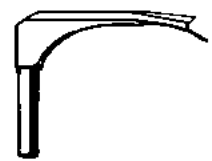

4665 M
39860 H

VASTISSIMO ASSORTIMENTO DI AGHI
PER TUTTE LE LAVORAZIONI
E PER TUTTE LE INDUSTRIE.

KI. 39500

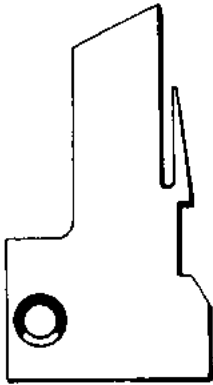

4666 M
39524 AB 1/8
(AX 1/8)

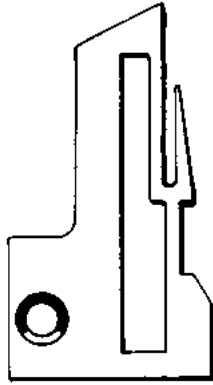

4066 M
39524 AB 1/8
(AX 1/8)

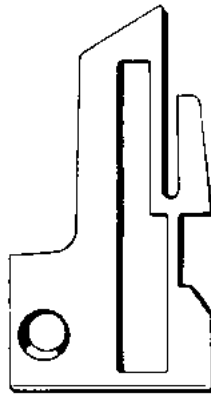

4667 M
39524 AB 5/32
(AX 5/32)

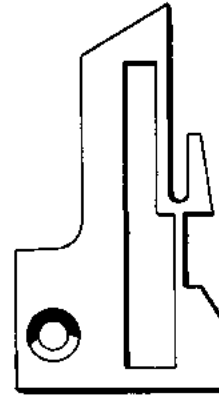

4065 M
39524 AC (AV)

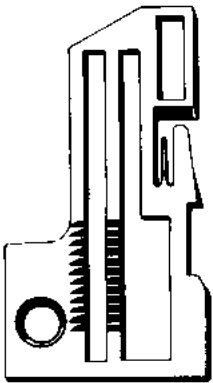

4078 M
G 39524 AV (GB)

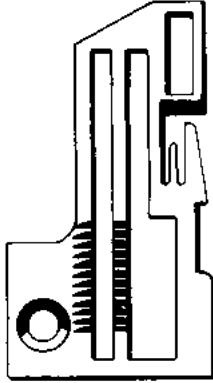

4068 M
G 39524 AW (GC)
GB 39524 AW (HN)

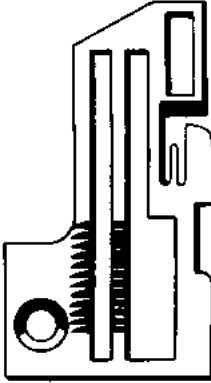

4061 M
GA 39524 AW (HH) 5/32

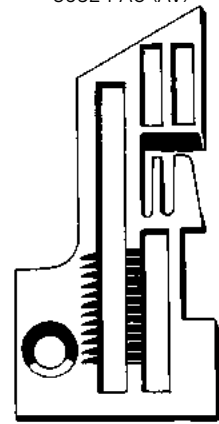

4668 M
39524 W (AN)

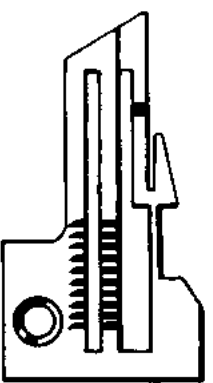

4069 M
39524 B 3/32
(V 3/32)

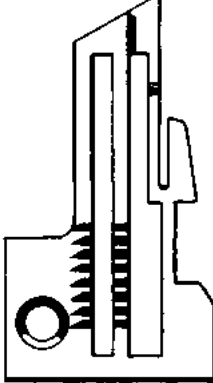

4070 M
39524 B 1/8
(V 1/8)

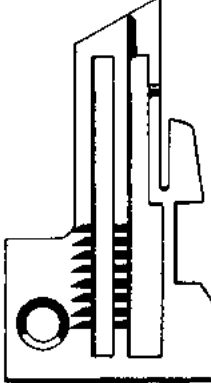

4071 M
39524 B 5/32
(BH)

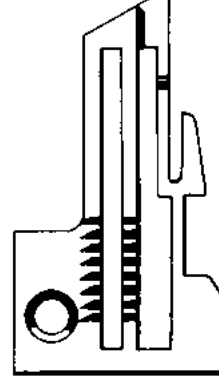

4669 M
39524 P
(AJ)

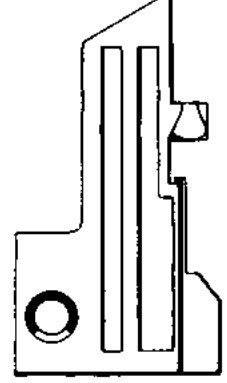

4072 M
39524 GA
(A 8924)

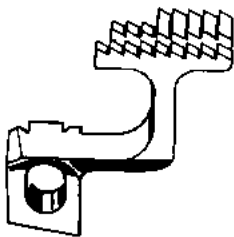

4670 M
39526 AW

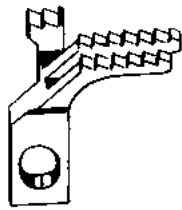

4671 M
39505 AW

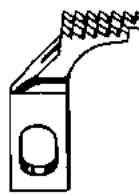

4672 M
39505 B

Kl. 39500 fortsetzung

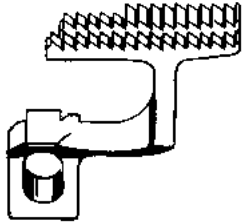

4673 M
39526

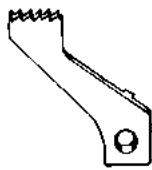

4674 M
39505

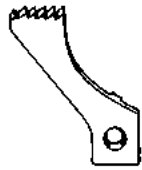

4675 M
39505 C

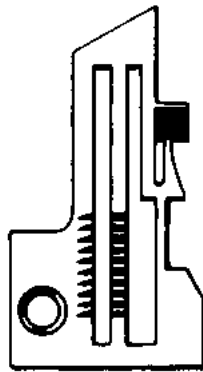

4073 M
39524 C 3/32
(AC 3/32)

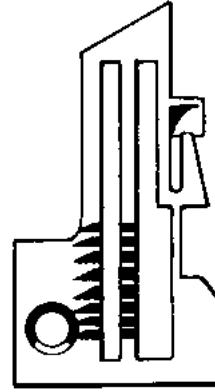

4074 M
39524 C 1/8
(AC 1/8)

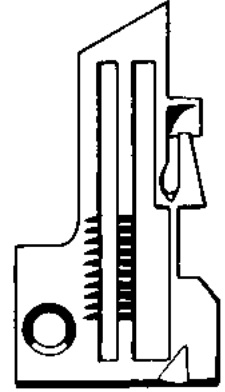

4676 M
A 9953 1/8
(HV 1/8)

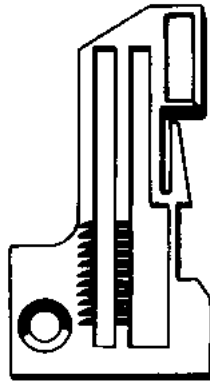

4062 M
GA 39524C 3/32 (HA)

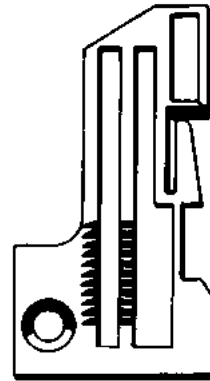

4063 M
GA 39524C 1/8 (HB)

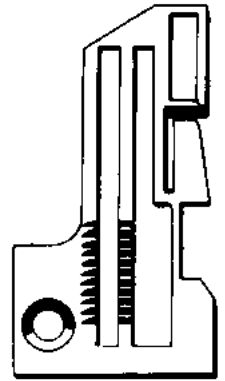

4064 M
GA 39524C 5/32 (HC)

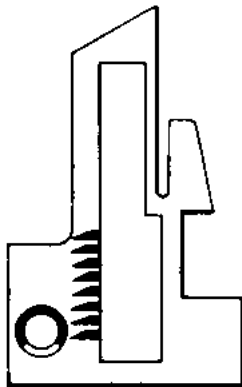

4075 M
39524 J 3/16

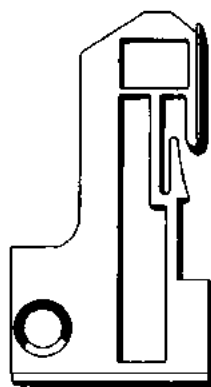

4083 M
G 36524 JU
(GI)

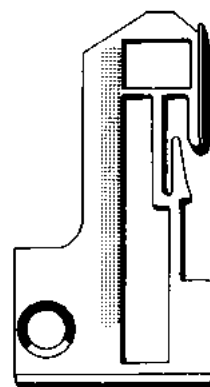

4084 M
GA 39524 JU
(HE)

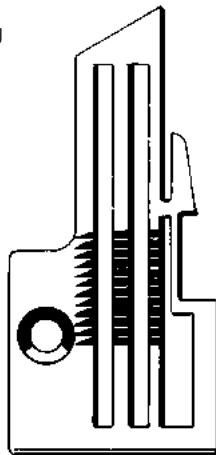

4677 M
39524 BF 1/8 (BK)

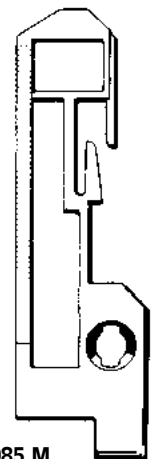

4085 M
A 9608 B (HG)

Kl. 41300

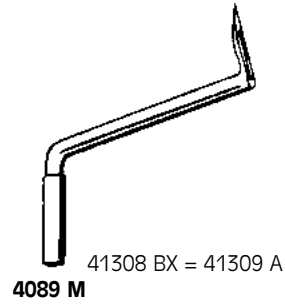

Kl. 51200

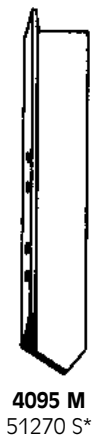

Kl. 51400



Kl. 52300



Kl. 52700

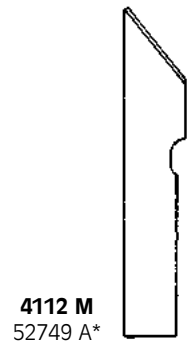

Kl. 52700 BKZ Galkin

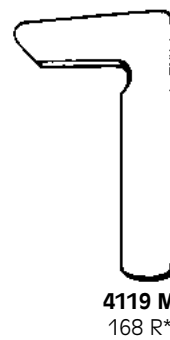
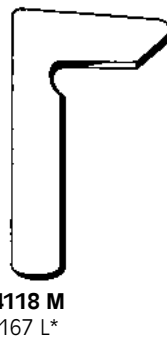

Kl. 53100

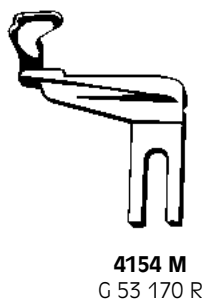

Kl. 53300, 53400

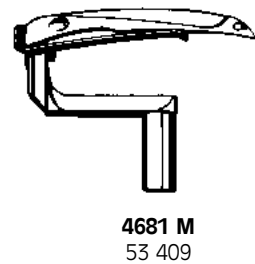

Kl. 52900



4125 M
52970 D*



4126 M
52970 E*



4127 M
A 9464 = 52970 D
con vicia



4128 M
52949 A*



4129 M
52949*



4130 M
52970 C*

Kl. 52 900, 52 800

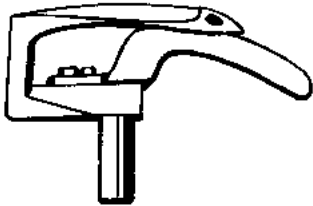

4136 M
52808 E

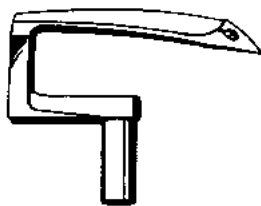

4137 M
G 52908 B

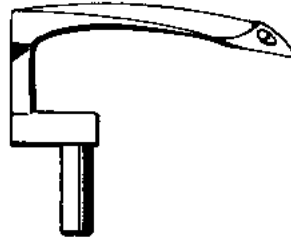

4138 M
52909 A

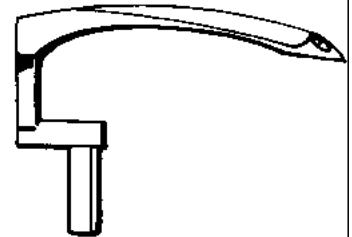

4139 M
52909 E-16 (CE)

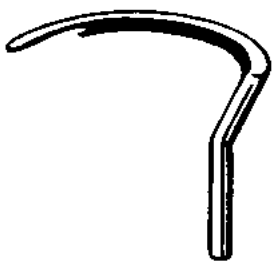

4140 M
52845 A (B) = 52945 M (F)

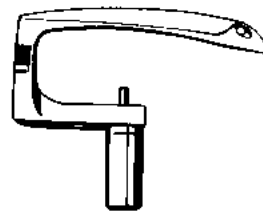

4141 M
52708 B

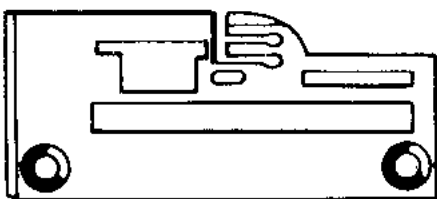

4145 M
G 52928 A 5-8



4146 M
52928 A 16-8

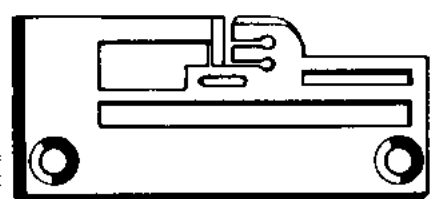

4147 M
52924 BH 5-8

KI. 75000

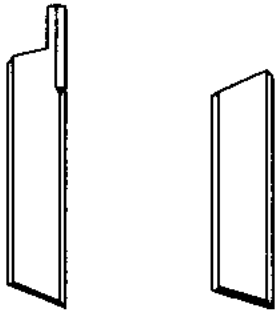

4159 M
75077*

4160 M
75049*

KI. 75400

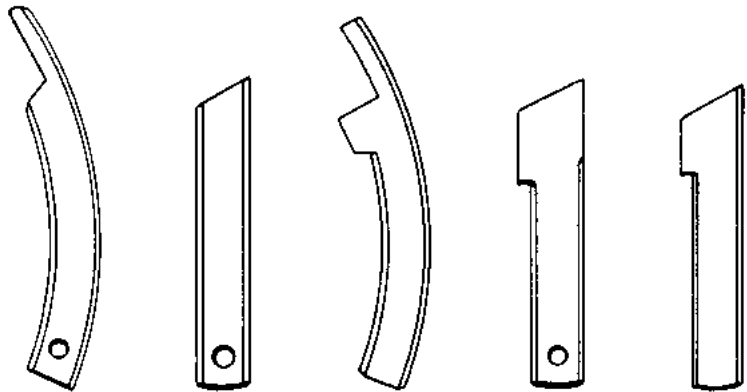

4166 M
75470*

4167 M
75449*

4168 M
75470 LA*

4169 M
75449 LA*

4170 M
75449 LB*

KI. 81200, 80200, 80600

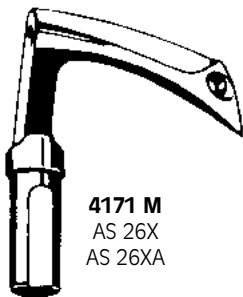

4171 M
AS 26X
AS 26XA

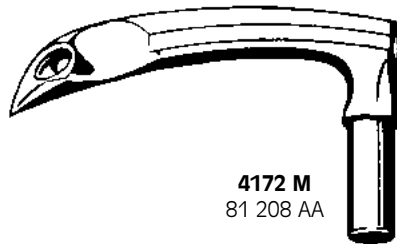

4172 M
81 208 AA

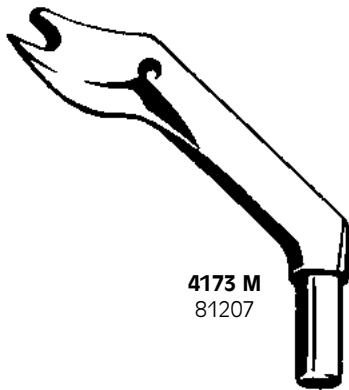

4173 M
81207

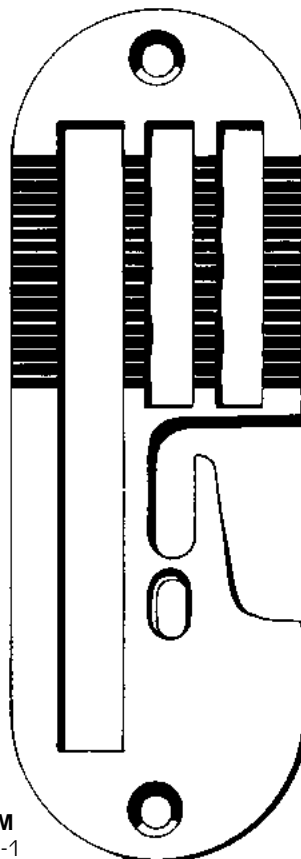

4174 M
81 224-1

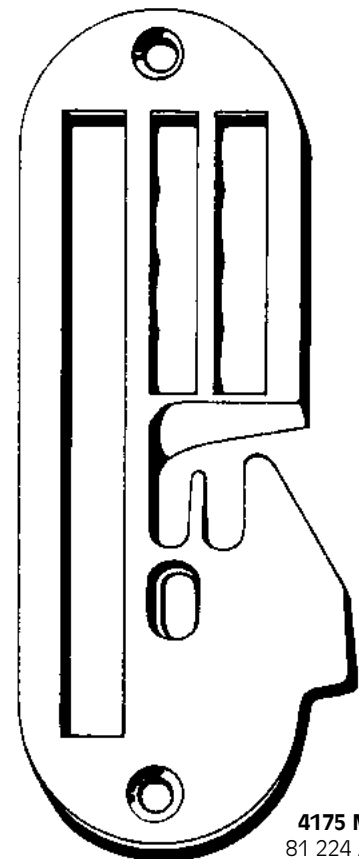

4175 M
81 224 AB

Kl. Overlock



4181 M
1662*



4182 M
1657*



4183 M
1662*



4184 M
1655*



4185 M
5350*

Kl. 30-A Metropolitan



4190 M
525 W

Kl. 1301 Fatlock e Feldlock



4195 M
3544*
e 3544 A



4196 M
3543*



4197 M
3055*



4198 M
3282 A
312 810-001



4199 M
3284 C



4200 M
3283 D



4201 M
3018 D



4202 M
3018

MOLTO IMPORTANTE

Questo Catalogo annulla tutte le precedenti edizioni. Avendo apportato notevoli cambiamenti con aggiunte ed eliminazione di articoli, l'ordine numerico è così venuto spesso volte cambiato.

Preghiamo i Sigg. Clienti, nelle loro richieste, di voler sempre indicare oltre il numero e la descrizione dell'articolo, anche la relativa pagina di Catalogo.

KI. 503, 504, 512, 514, 515, 516

210755
 CT 210 755 = 91-179 421-01
 211 771 = 09-009 807-71



4209 M
 202 570
 323-870-200
 09-009 052-54



4208 M
 201 121 A
 323-870-214
 09-009 050-06
 (CT)

205607:
 con vidia



4210 M
 202 571
 323-870-201
 09-009 052-56

CT=
 202 527
 323-870-207
 09-009 070-82

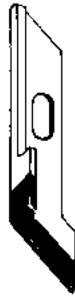

4211 M
 con vidia



4215 M
 202 572
 323-870-202
 09-009 052-56
 202 295
 323-870-210
 09-009 066-42

205 609:



4212 M
 202 893
 323-870-215
 (CT)
 con vidia

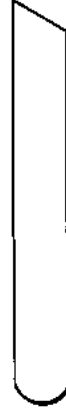

4216 M
 202 573
 323-870-203
 09-009 052-57
 201 127
 323-870-211
 09-009 054-43



4217 M
 204 161
 323-870-213
 09-009 052-33



4213 M
 204 351
 323-870-218
 (CT)
 con vidia



4251 M
 202 874 (1)
 323-810-211
 09-009 053-31



4252 M
 204 062 (2)
 323-810-218
 09-009 054-19

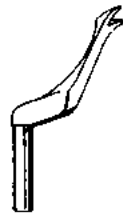

4253 M
 204 278 (1)
 323-810-215
 09-009 054-29

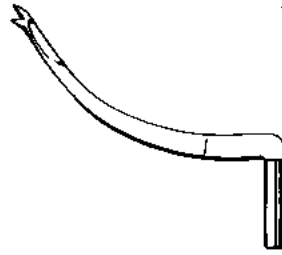

4254 M
 201 234 A
 323-810-003
 09-009 050-62

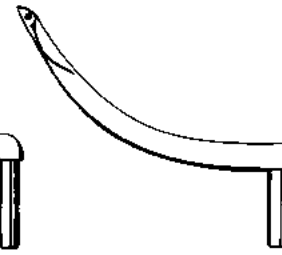

4255 M
 201 067 A
 323-810-001
 09-009 049-43



4256 M
 201 085 B
 323-810-002
 09-009 049-56

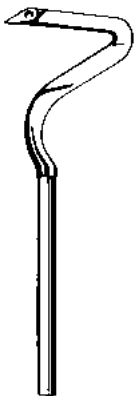

4239 M
 202 861
 323-810-212
 09-009 053-29

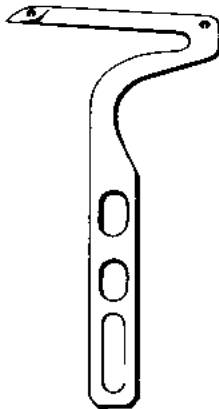

4257 M
 204 072
 323-810-216
 09-009 054-20

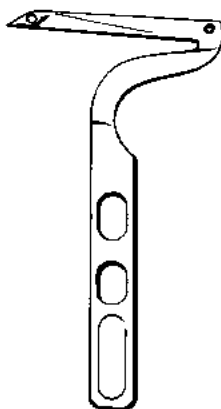

4240 M
 204 991
 323-810-232
 09-009 603-49



4258 M
 204 314 A
 323-810-217
 09-009 065-25

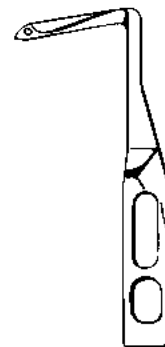

4241 M
 204 431
 323-810-219
 09-009 065-26

Kl. 503, 504, 512, 514, 515, 516

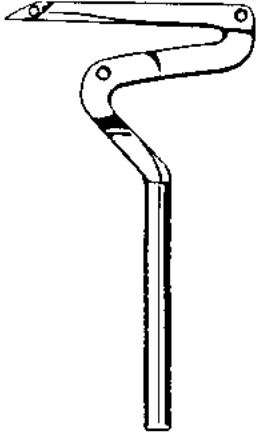

4595 M
202 703
323-810-222
09-009 065-89



4596 M
202 828 (4)
323-810-224
09-009 065-90



4597 M
204 663 (7)
323-810-008
09-009 068-07



4598 M
204 990 (12)
323-810-231
09-009 603-48



4599 M
204 702 (4)
323-810-009
09-009 067-70



4600 M
204 703 (6)
323-810-010
09-009 067-68



4601 M
204 704 (3)
323-810-011
09-009 068-98



4602 M
204 705 (5)
323-810-012
09-009 067-69



4603 M
210 358 (2)
323-810-021
09-009 620-31



4604 M
210 359 (4)
323-810-022
09-009 616-01

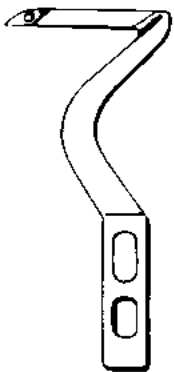

4605 M
210 354
323-810-018
09-009 615-98

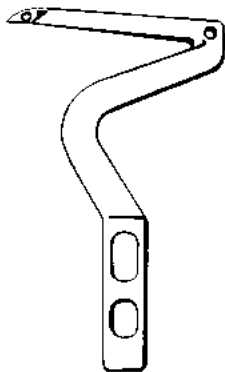

4606 M
210 356
323-810-019
09-009 615-99

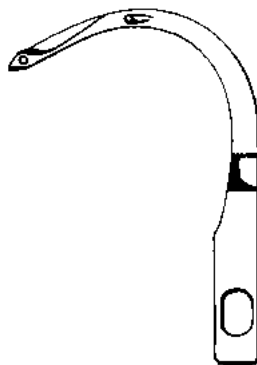

4607 M
210 357 A
323-810-020
09-009 616-00



4608 M
210 364 (22)
323-810-025
09-009 616-03



4609 M
210 365 (24)
323-810-026
09-009 616-04



4610 M
210 366 (26)
323-810-027
09-009 620-33

Kl. 503, 504, 512, 514, 515, 516

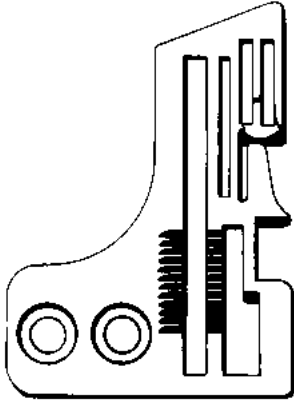

4611 M
205 321
09-009 611-37

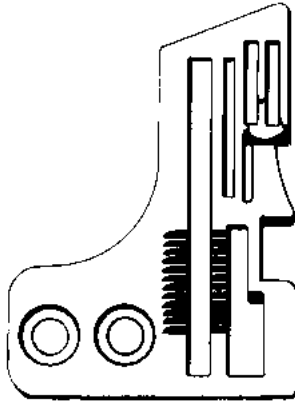

4612 M
205 322
09-009 070-90

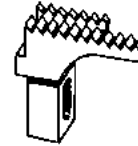

4613 M
208 336
09-009 611-68

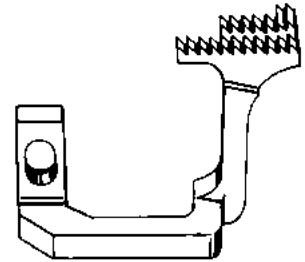

4615 M
204 907
09-009 068-97



4614 M
208 338
09-009 611-70

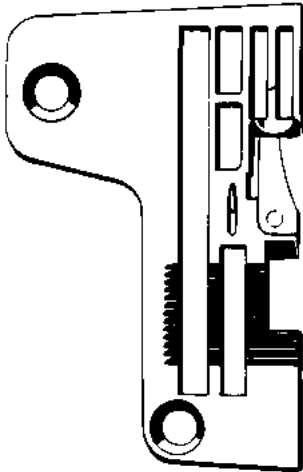

4616 M
204 252 B
09-009 065-65

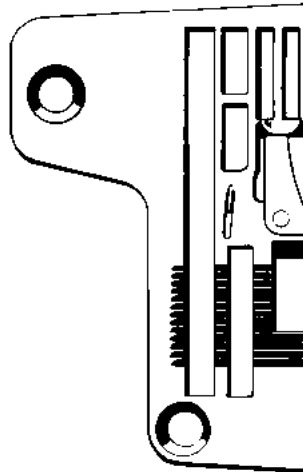

4617 M
204 360 A
09-009 065-40

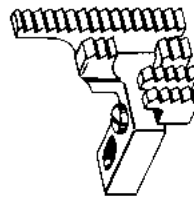

4618 M
208 063
09-009 071-19

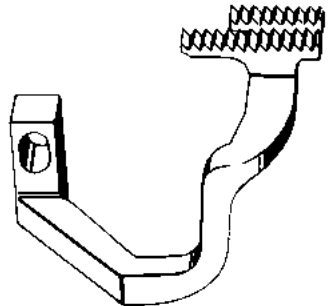

4619 M
208 215
09-009 071-27

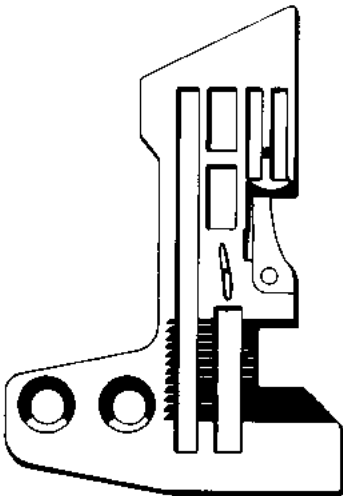

4620 M
210 846
09-009 620-09

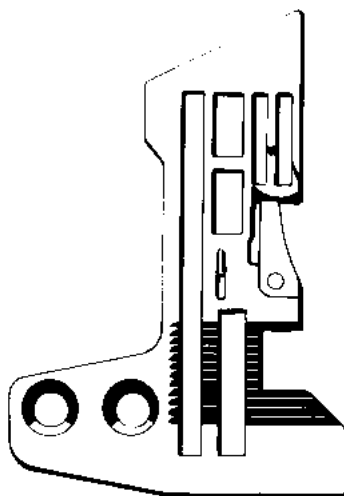

4621 M
210 851
09-009 620-14

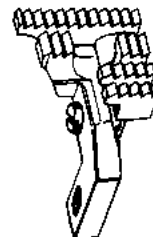

4622 M
210 851
09-009 606-75

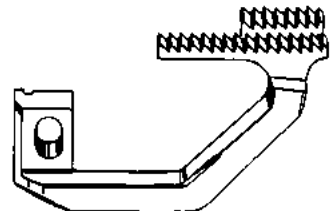

4623 M
210 494
09-009 616-98

Kl. 503, 504, 512, 514, 515, 516

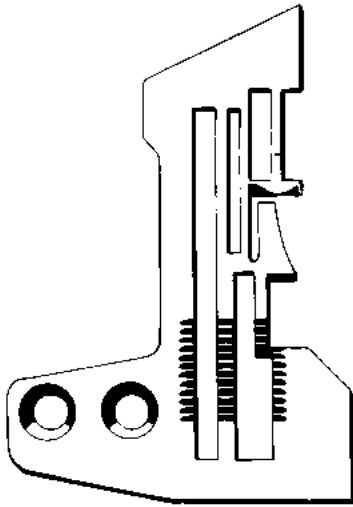

4624 M
210 787
09-009 620-45

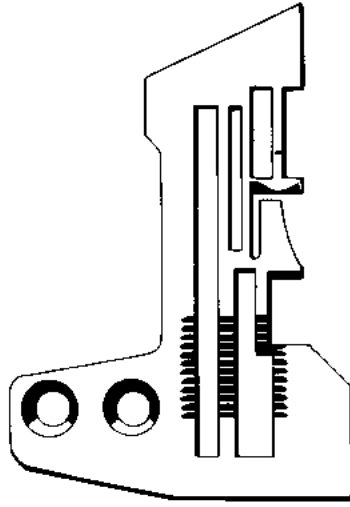

4625 M
210 788
09-009 620-45



4626 M
210 568
09-009 616-26

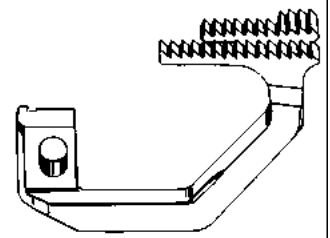

4627 M
210 443
09-009 616-57

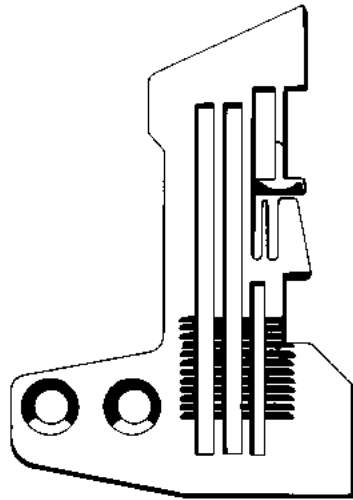

4628 M
210 810
09-009 620-66



4629 M
210 575
09-009 617-33

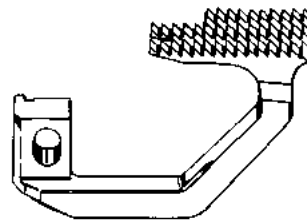

4630 M
210 445
09-009 616-58



4711 M
96-795 104-00
11 837 (T 830)

Kl. 68
= Treasure Kl. B S 800
bis 812

Kl. 4542, 4562
= Pegasus W 542, W 562

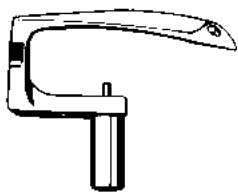

4632 M
257 550

Diversi pezzi per **W.&G.** sono
identici ai pezzi delle macchine
MAUSER e **PEGASUS**

Kl. 800, 1412 Superlock



4225 M
D 110—10*
313 870—003



4226 M
D 119—10*



4227 M
D 110—8A*
313 870—015

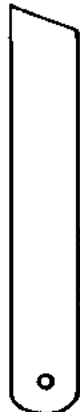

4228 M
D 119—7*



4229 M
D 119—5C
con vidia
313 870—012



4230 M
441 031
con vidia
313 880—005



4231 M
442 001
313 810—012

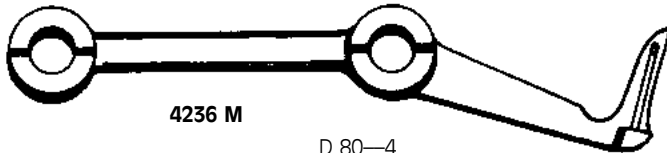

4236 M

D 80—4
313 810—001



4237 M
D 60—2
D 60—7
313 810—003



4238 M
D 60—3
313 810—010

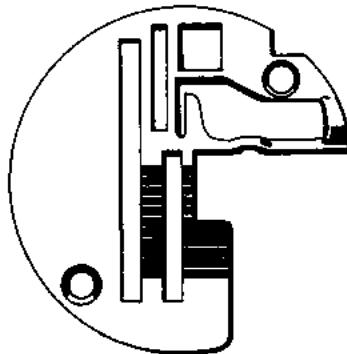

4245 M
D 250—17 B

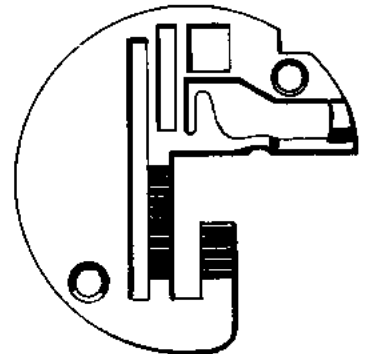

4246 M
D 250—18 A
313 801—025

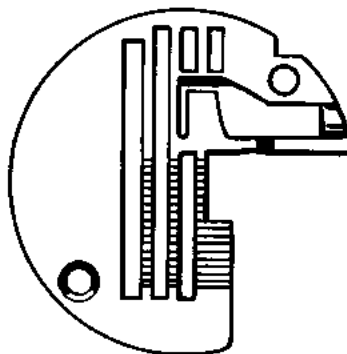

4247 M
D 250—39
313 801—036

KI. CM-263, CM-268



4712 M
80 413

KI. DCZ 203, 220, 222

KI. DC, DCY, DCZ 331, 341, 361, 520, 521

KI. Z 830, 831, 833

KI. Z 610



4260 M
37 514
CT 37 514



4261 M
37 538
CT 37 538



4262 M
Y 37 301

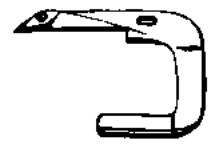

4263 M
Y 37 302

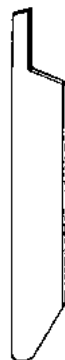

4264 M
38 332



4265 M
con vidia
32 914
(CT)



4267 M
30 421
CT 30 421



4685 M
35 285

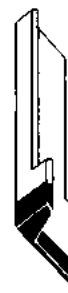

4266 M
con vidia
35 286
35 211

Kl. DCZ 203, 220, 222
 Kl. DCZ 331, 341, 361
 Kl. 520, 521
 Kl. Z 830, 831, 833
 Kl. Z 610

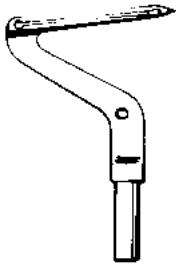

4278 M
 34 392
 32 790

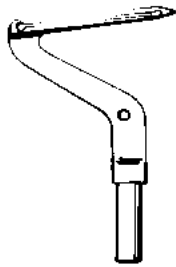

4279 M
 34 393
 32 415

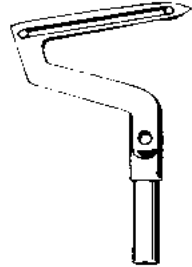

4285 M
 32 541

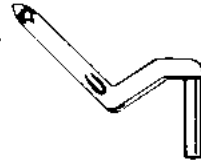

4284 M
 35 227
 32 539

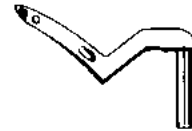

4685 M
 34 730
 alte Nr. 34 599

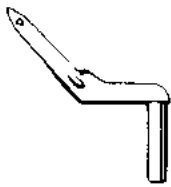

4289 M
 32 807

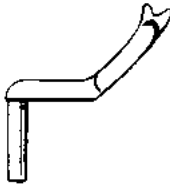

4290 M
 32 813

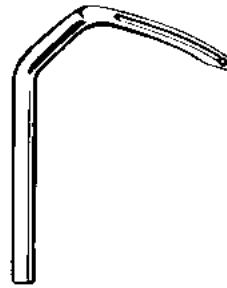

4293 M
 33 059

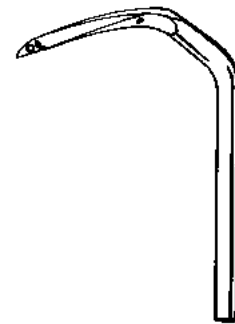

4686 M
 31 877

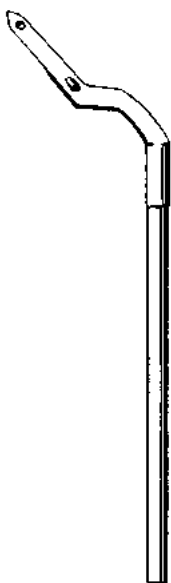

4294 M
 34 113

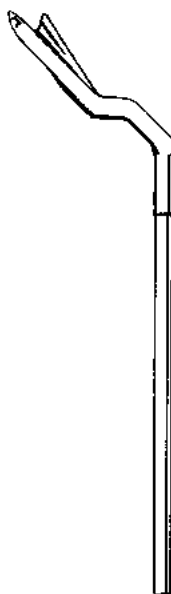

4295 M
 34 120

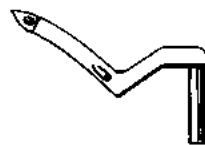

4687 M
 34 519



4688 M
 34 584

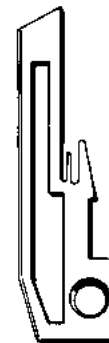

4689 M
 35 856

Kl. Z 1000, Z 1003, Z 1020, Z 1021, Z 1025
 Kl. Z 1500, Z1502
 Kl. ZF 1020, ZF 1003, ZF 1025, ZF 1026, ZR 1020
 Kl. Z 2000, Z 3000, Z 5000, Z 5000, Z 6000
 Kl. AZ 8000, AZ 85000

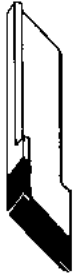

4690 M
 con vidia
 20 491
 CT 20491



4691 M
 con vidia
 20 496



4692 M
 con vidia
 23 580



4693 M
 20 498



4694 M
 22 195



4695 M
 23 582



4696 M
 2100 167

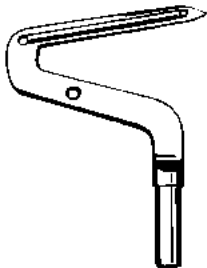

4697 M
 21 701

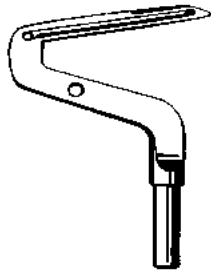

4698 M
 21 757

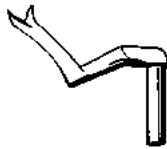

4699 M
 21 752

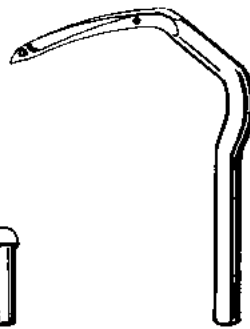

4700 M
 25 046
 20 378

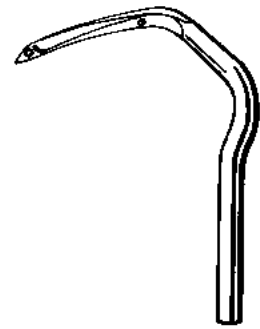

4701 M
 20 577

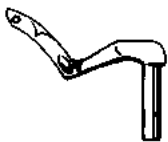

4702 M
 21 756

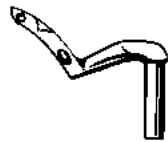

4703 M
 21 700

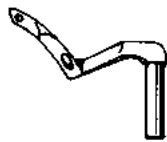

4704 M
 27 012

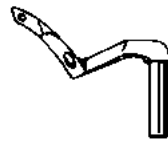

4705 M
 27 013



4706 M
 21754

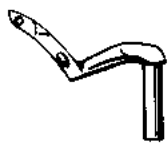

4707 M
 22 012

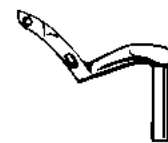

4708 M
 22 011

KI. 503 - D1, D2, D3, D4

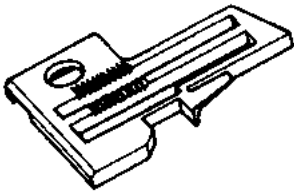

34564 D1
34565 D2
34566 D3
34567 D4

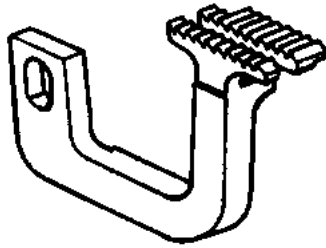

33840



33814
D1, D2, D3, D4

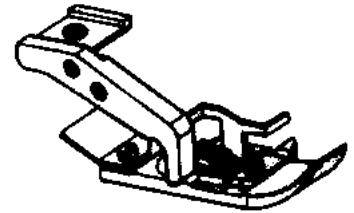

32747 D1, D2, D3
32394 D4

KI. 515 - D2, D3

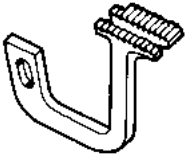

33840 D2
33842 D3



33814 D2
33818 D3



35264

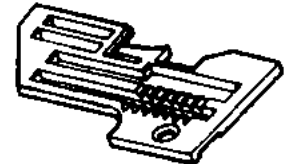

34671

KI. 520 - D1, W

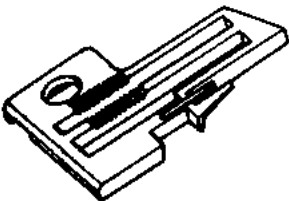

34585/34598 D1
34593 W

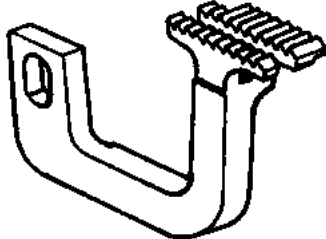

33840
33842

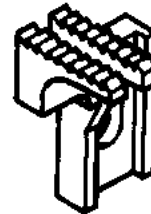

33814
33818

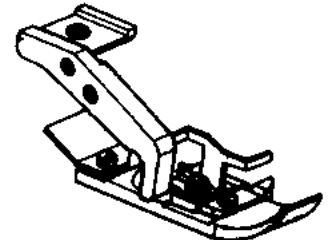

32750
32760

KI. 521 - D1, 525

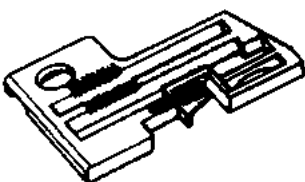

34600

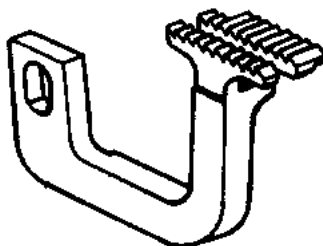

33840



33814



32341

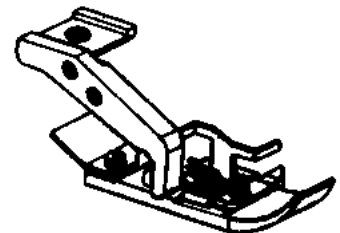

32343
32751 (525)

KI. 554

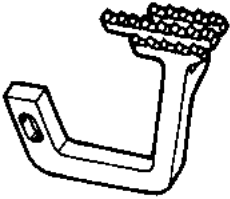

34706



34705

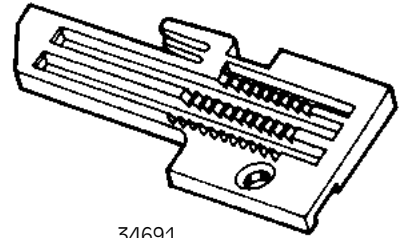

34691

KI. 361 A - D1, D2, D4

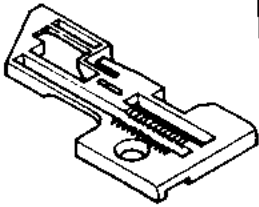

33540 D1
33541 D2
33531 D4

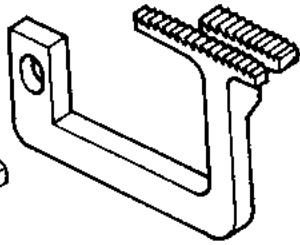

33824
33826
33836 D4

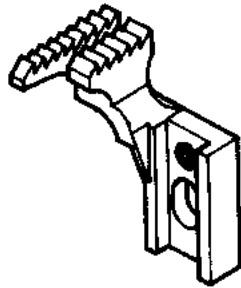

33825
33827



33544
33559

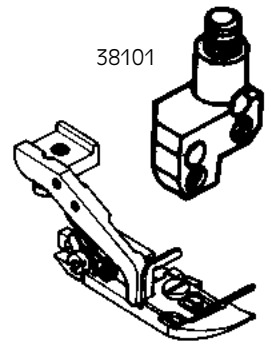

38101
33537 D1 - D2
33533 D4

KI. 361 Y - D1, D2

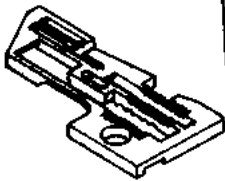

33542 D1
33543 D2

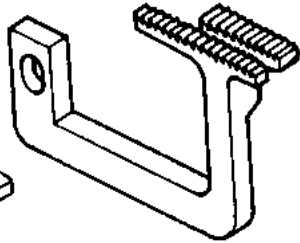

33824

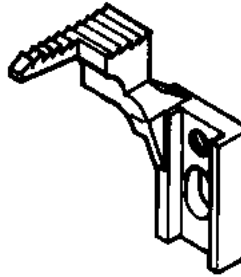

33255



33544

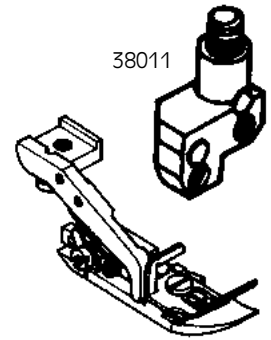

38011
33538

KI. 361 C

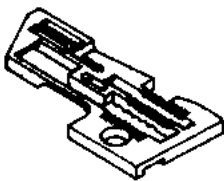

33545

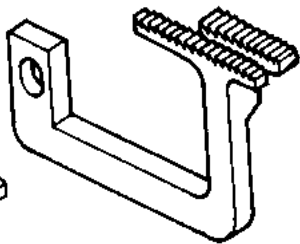

33828
33830
33834

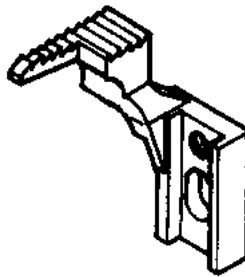

33829
33831
33835



33328
33549

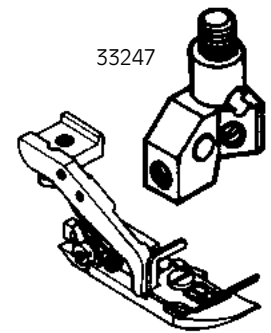

33247
33539

KI. 341 C - D4

MORSETTO AGO

33247

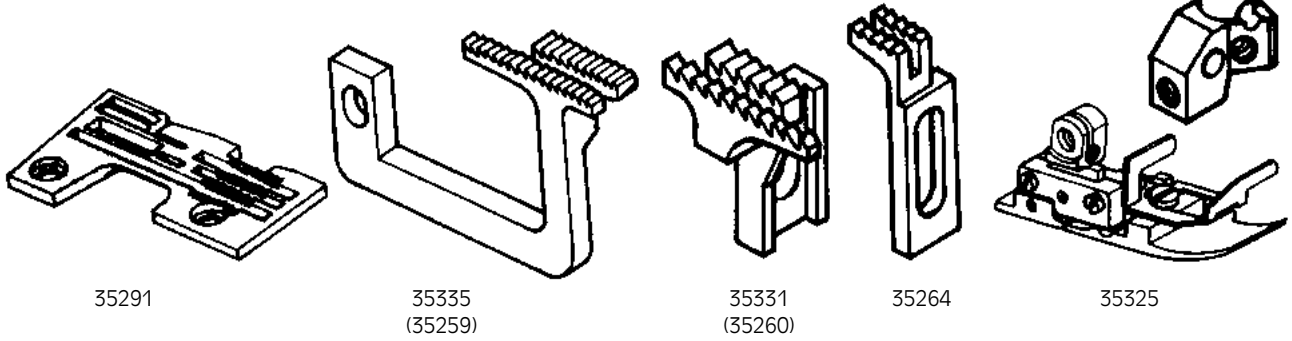

KI. Z 2003-04, 06

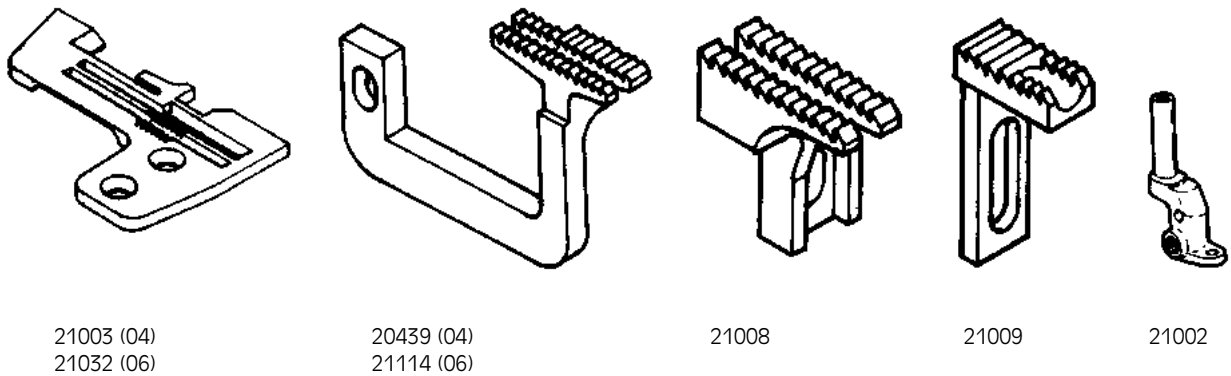

KI. Z 2020 Y6

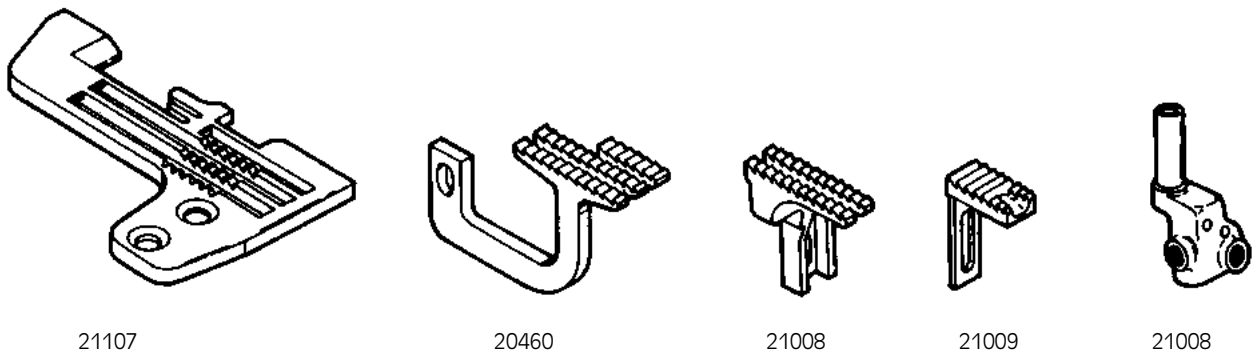

KI. Z 2021 A6, A7

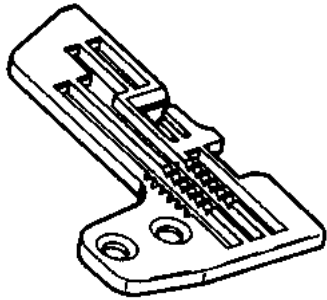

21162 (A6)
21163 (A7)

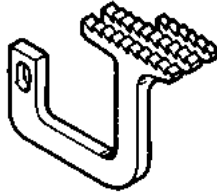

21114



21008



21151

KI. Z 3000 A4, A5

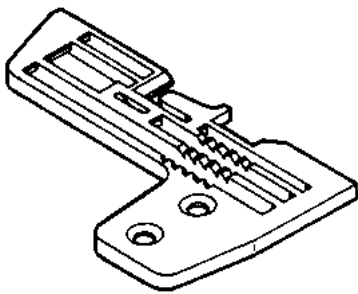

20210 (A4)
20211 (A5)

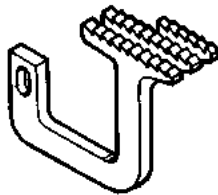

20439 (A4)
20460 (A5)

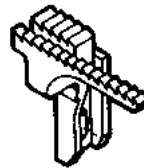

20440



20441

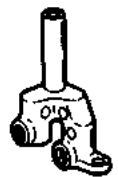

20200

KI. Z 3000 Y4

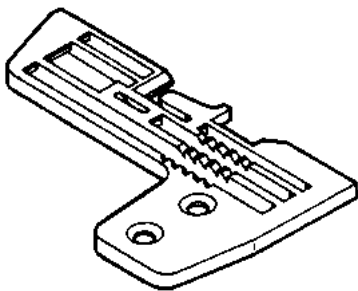

20208

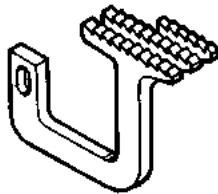

20439 (A4)

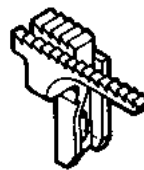

20440



20441

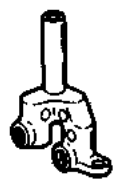

20201



0093358
Morsetto ago

	mm	Codice N.	3 Aghi
7/32"	5.56	0093357	
1/4"	6.35	0093358	

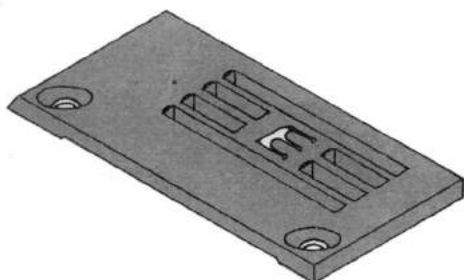

0094802
Placca ago

	mm	Codice N.	3 Aghi
7/32"	5.56	0094801	
1/4"	6.35	0094802	

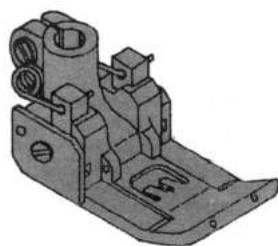

0064042
Piedino

	mm	Codice N.	3 Aghi
7/32"	5.56	0064041	
1/4"	6.35	0064042	

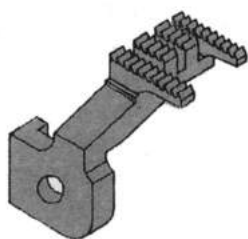

3109003
Griffa posteriore

	mm	Codice N.	3 Aghi
7/32"	5.56	3109001	
1/4"	6.35	3109003	

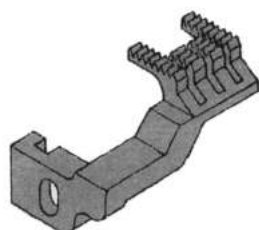

3109002
Griffa anteriore

	mm	Codice N.	3 Aghi
7/32"	5.56	3109000	
1/4"	6.35	3109002	



0093358
Morsetto ago

	mm	Codice N.	3 Aghi
7/32"	5.56	0093357	
1/4"	6.35	0093358	

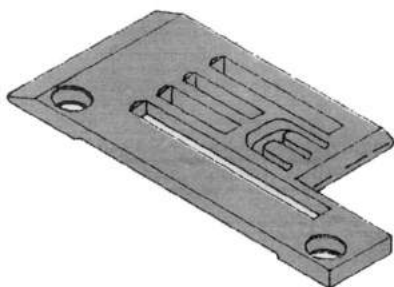

0094902
Placca ago

	mm	Codice N.	3 Aghi
7/32"	5.56	0094901	
1/4"	6.35	0094902	

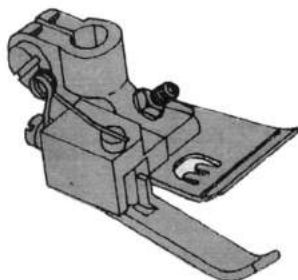

0094909
Piedino

	mm	Codice N.	3 Aghi
7/32"	5.56	0094908	
1/4"	6.35	0094909	

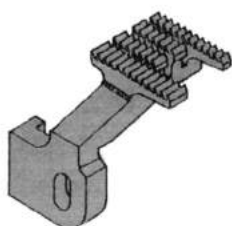

3109021
Griffa posteriore

	mm	Codice N.	3 Aghi
7/32"	5.56	3109018	
1/4"	6.35	3109021	

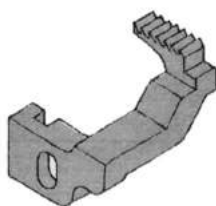

3109022
Griffa anteriore

	mm	Codice N.	3 Aghi
7/32"	5.56	3109017	
1/4"	6.35	3109022	



0093358
Morsetto ago

	mm	Codice N.	3 Aghi
7/32"	5.56	0093357	
1/4"	6.35	0093358	

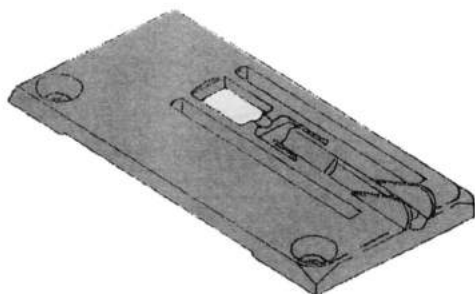

3008021
Placca ago

	mm	Codice N.	3 Aghi
7/32"	5.56	3008020	
1/4"	6.35	3008021	

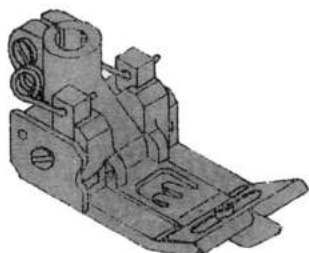

0091094
Piedino

	mm	Codice N.	3 Aghi
7/32"	5.56	0094093	
1/4"	6.35	0094094	

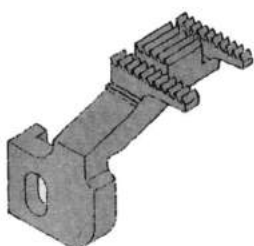

31090031
Griffa posteriore

	mm	Codice N.	3 Aghi
7/32"	5.56	3109031	
1/4"	6.35	3109031	

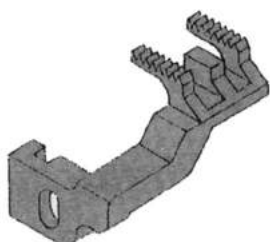

9109030
Griffa anteriore

	mm	Codice N.	3 Aghi
7/32"	5.56	9109030	
1/4"	6.35	9109030	

KI. Z 3000 C5

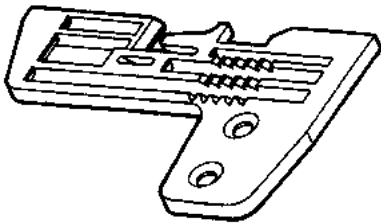

20212

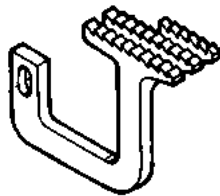

20460

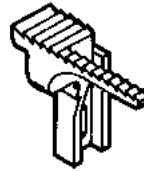

20461



20441

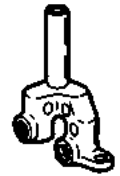

20202

KI. Z 5003-03, 04

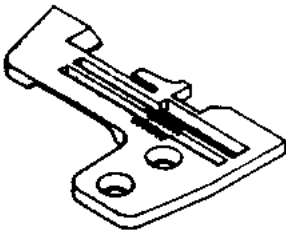

21768 (03)
21769 (04)

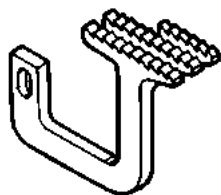

21846

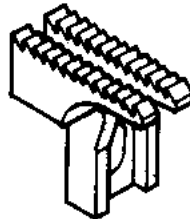

21842



21009

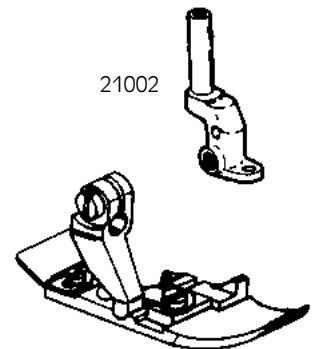

21002

23000 (03)
23002 (04)

KI. Z 5020-x4

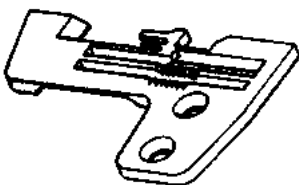

21781

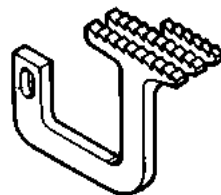

21847

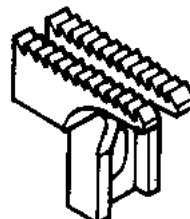

21842



21009

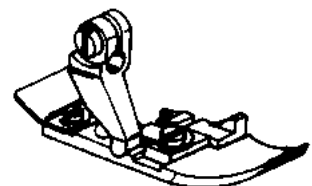

23030

Kl. Z 5020-x5

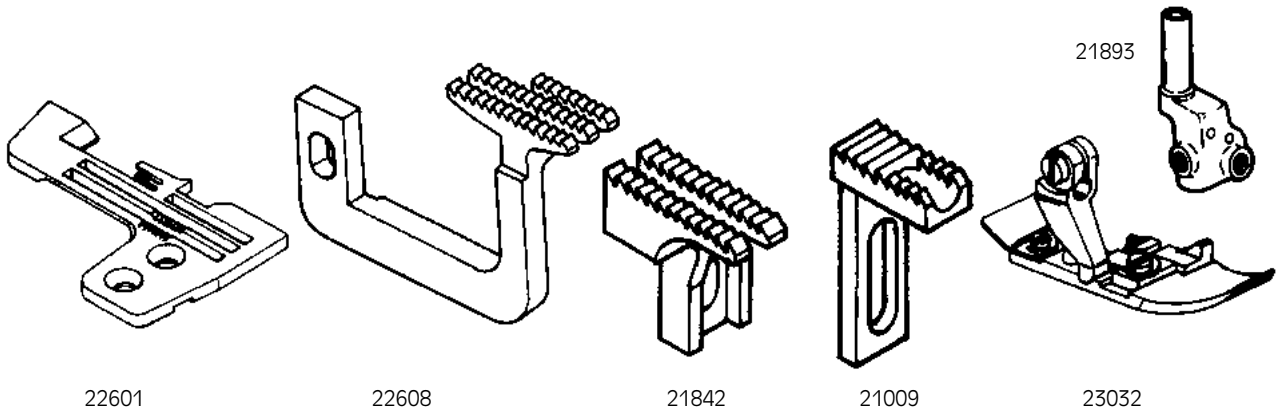

22601

22608

21842

21009

21893
23032

Kl. Z 6000-A3, A4

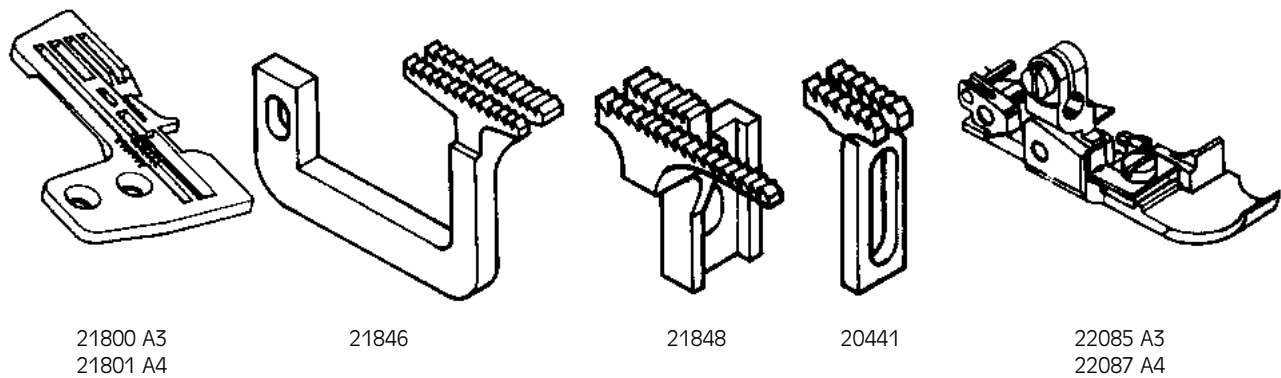

21800 A3
21801 A4

21846

21848

20441

22085 A3
22087 A4

Kl. Z 6000-A5, A6

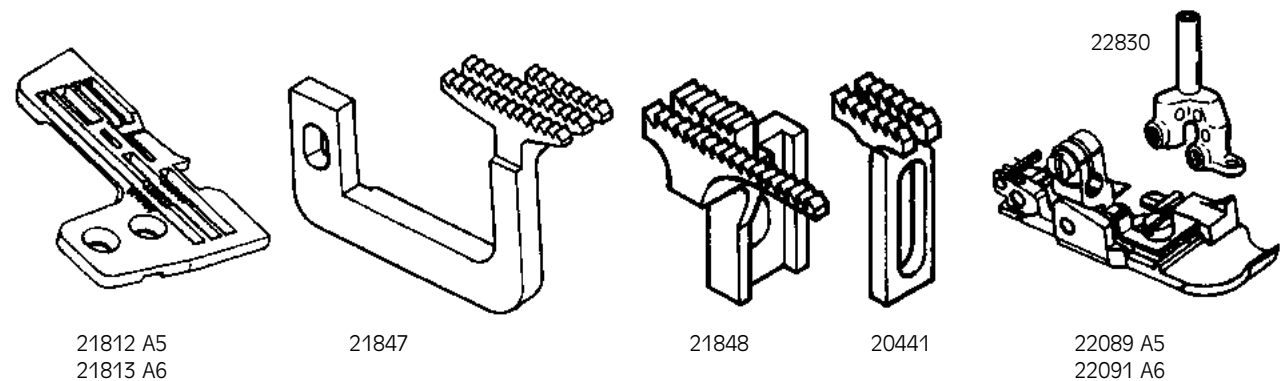

21812 A5
21813 A6

21847

21848

20441

22830
22089 A5
22091 A6

Kl. Z 6000 - C5, C6

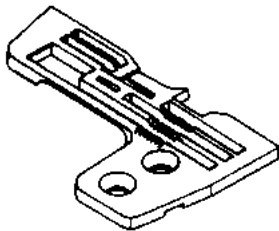

20212 C5
22075 C6

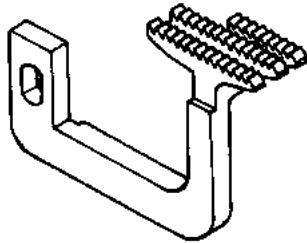

20460

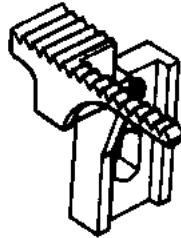

20461



20441

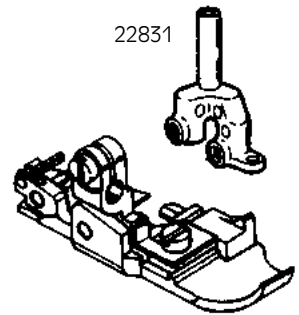

22831
22131 C5
22133 C6

Kl. ZF 1003 - 04, 06

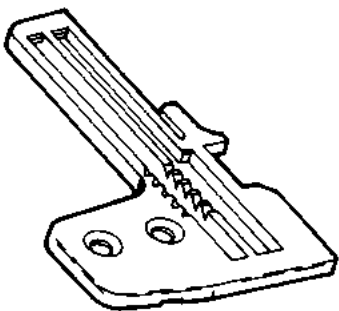

24224 (04)
24231 (06)

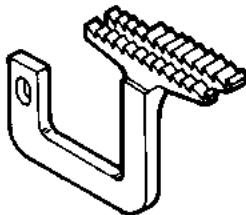

24180 (04)
24182 (06)

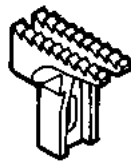

21842



21009

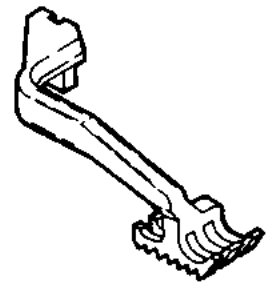

Griffa superiore
26511 (04)
26510 (06)

Kl. ZF 1020 Y6

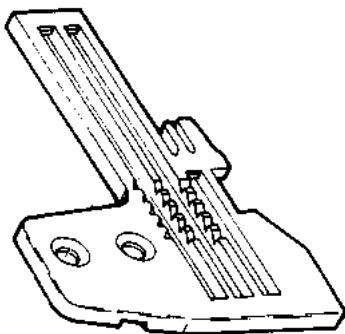

24236

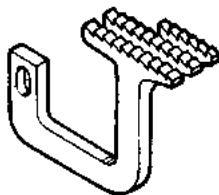

24182

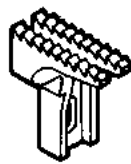

21842



21009

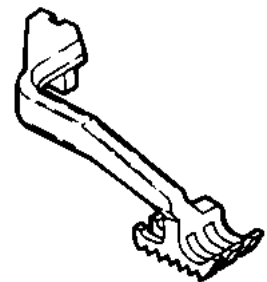

Griffa superiore
26510

KI. ZF 1500 A

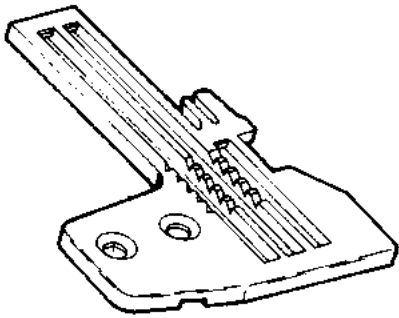

27002

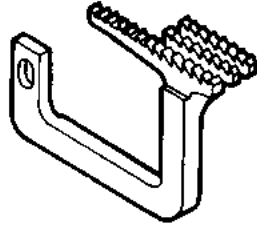

27003

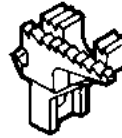

25015



25017

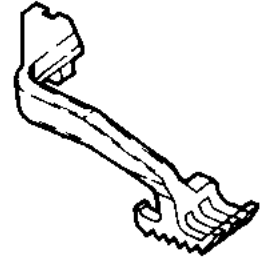

Griffa superiore
27280

KI. AZ 8003-03, 05

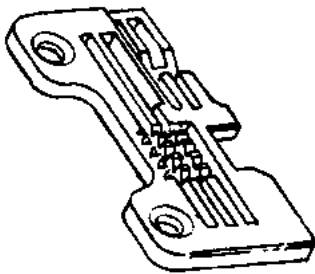

2108002 (03)
2108007 (05)

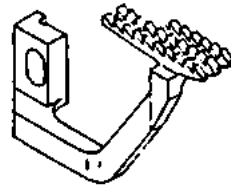

2109007 (03)
2109005 (05)



2109006



2109052



2109100

KI. AZ 8020 Y5, X4

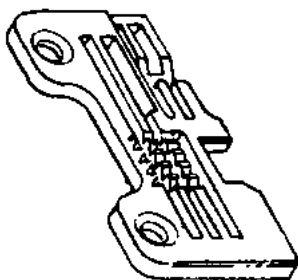

2108004 Y5
2108006 X4

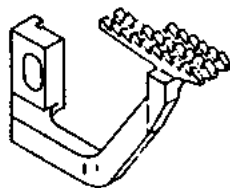

2109005



2109006



2109052



2109101
2109102

KI. DV 1200, 1250, 1400

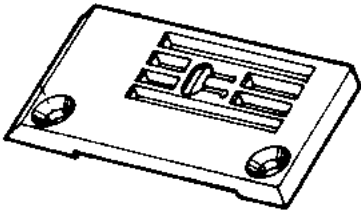

93171 (B) 4,0
93172 (C) 4,8

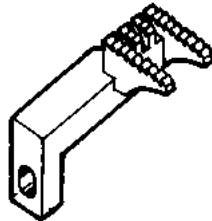

93394

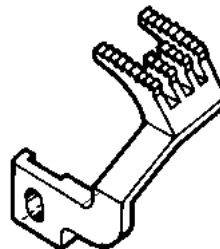

93395

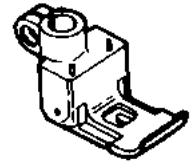

91132 (B) 4,0
91133 (C) 4,8

KI. DV 1300, 1350, 1500

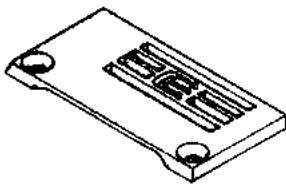

94800 (C) 4,8
94801 (D) 5,6
94802 (E) 6,4

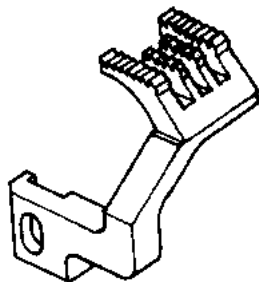

93394 (C-D)
93396 (E)

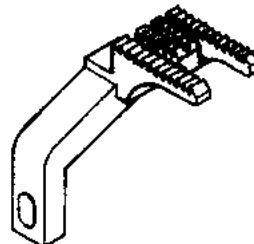

93395 (C-D)
93397 (E)

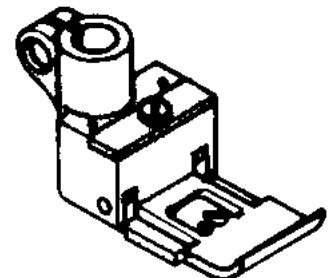

90732 (C)
90722 (D)
90731 (E)

KI. DV 1203, 1253



94210 (A) 3,2
94211 (B) 4,0
94212 (C) 4,8

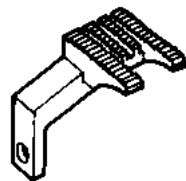

94231

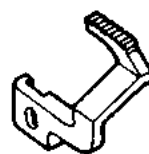

94230

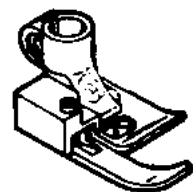

94215 (A)
94216 (B)
94217 (C)

Kl. 1403

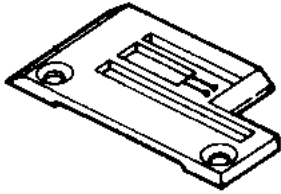

94281 (A) 3,2
94282 (B) 4,0
94283 (C) 4,8

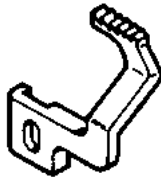

94260

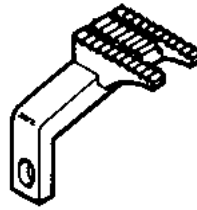

94261



94215 (A)
94216 (B)
94217 (C)

Kl. 1303 - 1353

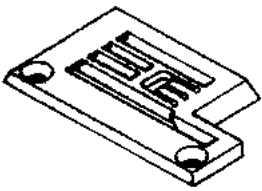

94901 (D) 5,6
94903 (E) 6,4

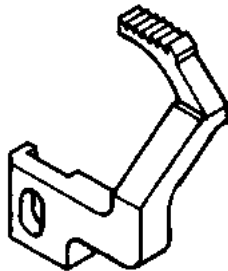

94230 (D)
94232 (E)

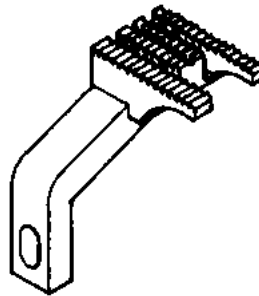

94231 (D)
94233 (E)

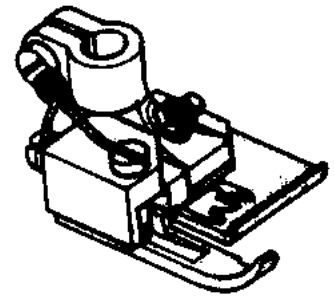

94908 (D)
94909 (E)

Kl. 1503

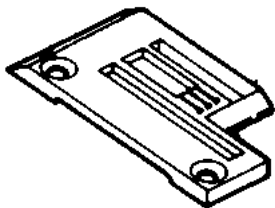

94921 (D) 5,6
94922 (E) 6,4

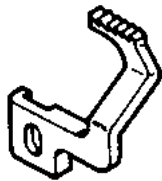

94260 (D)
94262 (E)

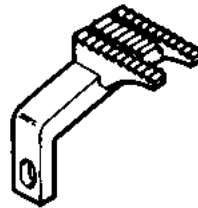

94261 (D)
94263 (E)

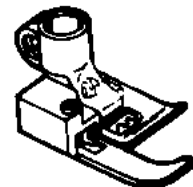

94908 (D)
94909 (E)

Kl. 1209 - 1259



91941 (A) 3,2
91942 (B) 4,0

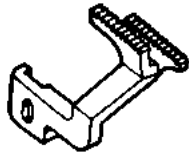

94592

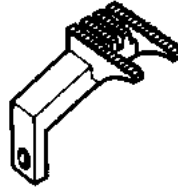

94593

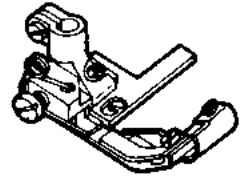

91965 (A)
91966 (B)

Kl. 1309 - 1359

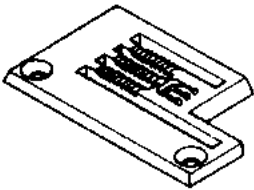

92152 (D) 5,6
92153 (E) 6,4

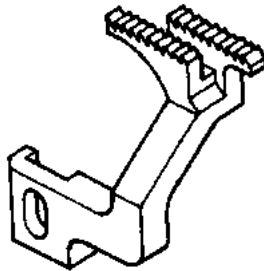

94592

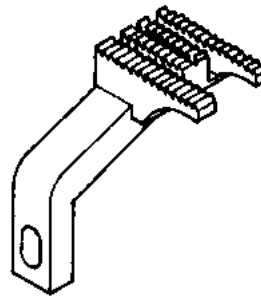

94593

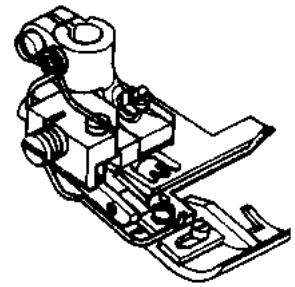

92158 (D)
92159 (E)

Kl. 1305 - 1355

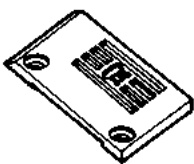

94801 (D) 5,6
94802 (E) 4,8

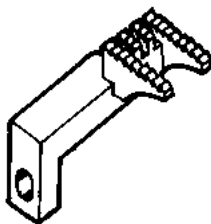

93394 (D)
93396 (E)

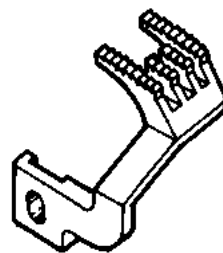

93395 (D)
93397 (E)

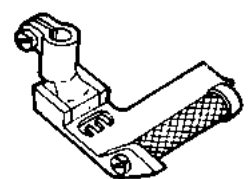

91197 (D)
91198 (E)

Crochet per macchine punto invisibile Blindstichnähmaschinen



4371 M
Columbia
36 C 22-1



4372 M
Lewis
36-16
Kl. 150



4373 M
US
3430-22

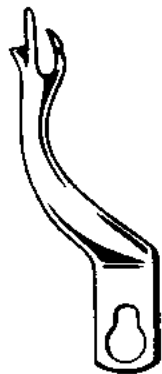

4374 M
MAIER
UNITAS
V 220111
Kl. 120 bis 251



4375 M
MAIER
UNITAS
232 111
V252 111
Kl. 232, 242, 252



4710 M
MAIER
UNITAS
V 14



4376 M
Dearborn
401 073
400 041



4377 M
Strobel
VLA 48-4
(18 702 Adamson)



4711 M
Treasure
11 837 (T 830)
Kl. BS 800, 808, 810-819,
830-844, 860-863
= Mauser Kl. 68-16 211-01
Kl. 68-17 321-01



4712 M
Yamato
80 413
Kl. CM-263, CM-268



4313 M
Strobel
18 7053



4714 M
Strobel
18 7052
Kl. 560-10 D

Pezzi per Fink & Sonk

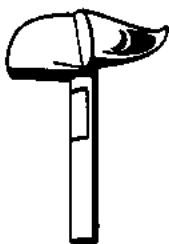

4385 M

Pezzi per AM 80

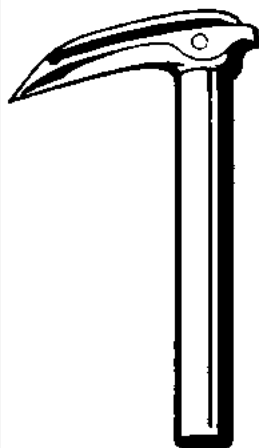

4390 M

Pezzi per Rimagliatrici (Kettma, Böttger, Sotco ecc.)



4310 M
JK-R
e VB-R
superiore



4311 M
JK-R
e VB-R
inferiore

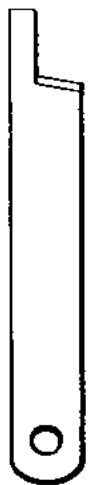

4312 M
JK-L
e VB-L
superiore



4313 M
JK-L
e VB-L
inferiore



4314 M
destro superiore
(Kettma ecc.)



4315 M
destro inferiore
(Kettma ecc.)



4316 M
sinistro superiore
(Kettma ecc.)



4317 M
sinistro inferiore
(Kettma ecc.)



4322 M
Satco
superiore



4323 M
Satco
inferiore



4324 M
Crochet a serpente
1 R, 2 R,
1 L, 235 L

VASTISSIMO ASSORTIMENTO
DI AGHI PER TUTTE
LE LAVORAZIONI
E PER TUTTE LE INDUSTRIE

Pezzi per British Shoe Machinery Co.

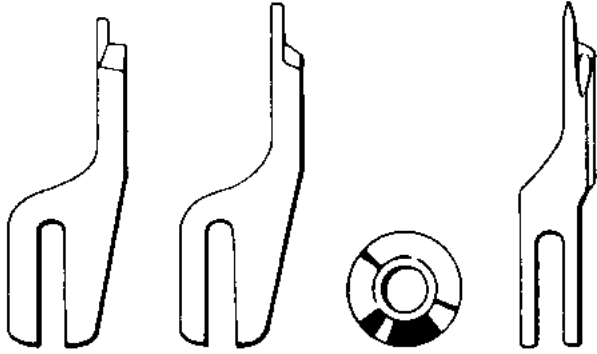

4340 M
KZG 502 E

4341 M
KZG 757

4342 M
KZG 1076

4343 M
KZG 295 E

Pezzi per Feld

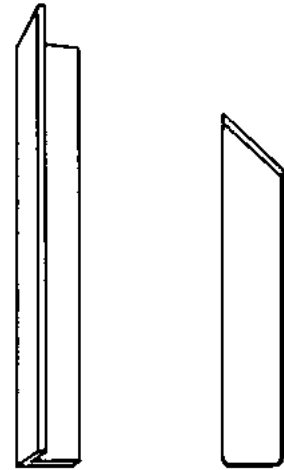

4349 M
132-17* superiore

4350 M
132-17* inferiore

Pezzi per Pegasus

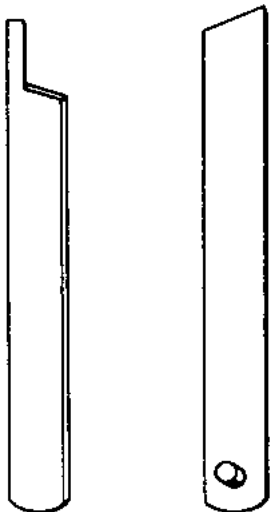

4355 M
138559*
KI. DCM 203
KI. DCM 220/230

4356 M
137562*
KI. DCM 203
KI. DCM 220/230

Pezzi per Peerless

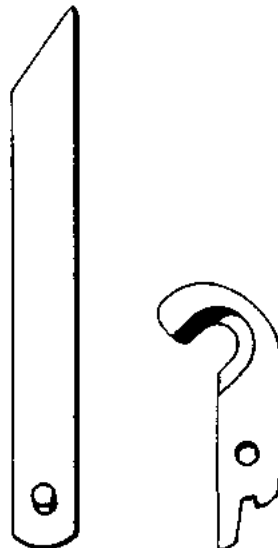

4359 M
113*

4360 M
110

Pezzi per Diamant FR

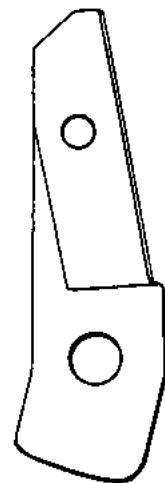

4365 M
*

UNIVERSALI

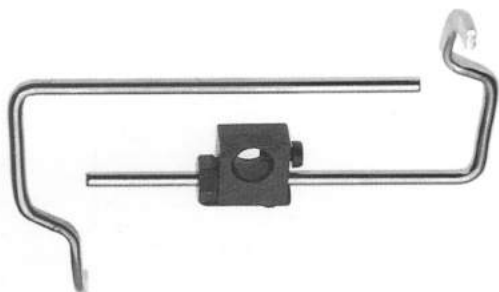

1318A \varnothing 9
1318A \varnothing 11
G 1318A \varnothing 14

TIPO NECCHI



1398A

GUIDA TRAPUNTO SPECIALE



4395 M
 \varnothing 13

GUIDA PER INTERNI



4399 M

GUIDA PER FETTUCCE



4400 M

CON MOTORE INCORPORATO

NUOVO MODELLO

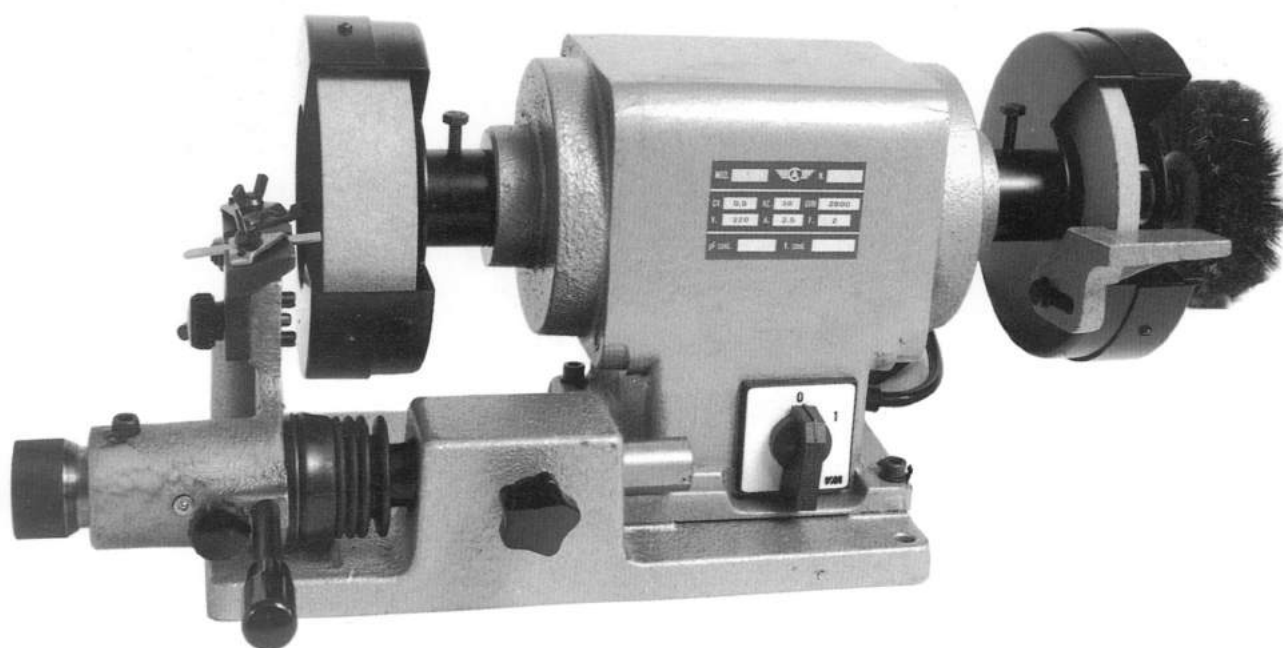

Accessori in dotazione

- Mola a tazza bianca Ø 125 x 35 x 12
- Mola piana Ø 125 x 10 x 12
- Pietra ravnivamole
- Chiave fissa esagonale mm. 10
- Chiave a tubo 17 x 19
- Supporto per applicazione mole supplementare

Dati tecnici

- Motore monofase 220 V. - 0,5 HP - 50 Hz
2800 giri/min. oppure:
- Motore trifase 220/380 - 0,5 HP - 50 Hz
- Diametro della mola 125 mm
- Velocità periferica della mola: 18,5 m./sec.
- Dimensioni: altezza cm. 21
lunghezza cm. 50
larghezza cm. 20
- peso: netto kg. 20 - lordo kg. 21

NELL'ORDINE SPECIFICARE SE DESIDERATE
IL MODELLO CON MOTORE TRIFASE O MONOFASE



N 51
Mola a tazza



N 52
Mola semplice



N 53
Mola Diamantata per coltelli vicia



N 54
Mola a disco per coltelli Pfaff



N 50
Mola a disco speciale
a lunga durata per coltelli Pfaff



N 49
Flangia porta mole



N 58
Disco stracci



N 57
Disco in feltro



N 55
Disco in fili di acciaio

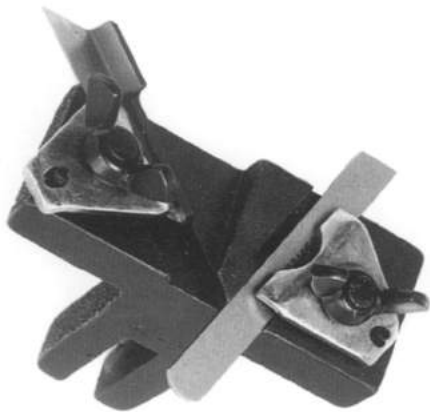

Portacoltello per tagliacuci



Supporto per affilatura delle forbici



Portacoltello per asolatrici



Portacoltello per Pfaff 471

L'affilatrice "CORNALI Mod. 125" è in grado di affilare qualsiasi tipo di coltelli per macchine tagliacuci, per asole, ecc.; inoltre, applicando un supporto, offre un piano inclinabile per affilare le forbici.

Siamo altresì in grado di fornire un portacoltello speciale con angolatura fissa, in modo che il coltello venga semplicemente inserito nella scanalatura e fissato, il che elimina qualsiasi errore di affilatura. Onde evitare equivoci, in caso di ordine, specificare la classe della macchina ed il numero originale del coltello. Qui di seguito Vi segnaliamo alcuni dei portacoltelli più comuni, abitualmente disponibili in stock;

PORTACOLTELLO per asolatrici PFAFF 3114 - DÛRKOPP 551 - SINGER 71-271
PORTACOLTELLO per ADLER 167
PORTACOLTELLO per ADLER 81
PORTACOLTELLO per BROTHER 955
PORTACOLTELLO per BROTHER 972
PORTACOLTELLO per BLINDSTITCH G1
PORTACOLTELLO per BLINDSTITCH G2
PORTACOLTELLO per placca SINGER 5730
PORTACOLTELLO per JUKI 2504
PORTACOLTELLO per JUKI 357
PORTACOLTELLO per JUKI 804
PORTACOLTELLO per MAUSER 2000 - W.&G. = PEGASUS
PORTACOLTELLO per MERROW 251
PORTACOLTELLO per MERROW 90/91
PORTACOLTELLO per PFAFF 151/153
PORTACOLTELLO per PFAFF 461/463
PORTACOLTELLO per PFAFF 471 Nuovo Modello
PORTACOLTELLO per RIMOLDI 25/26
PORTACOLTELLO per RIMOLDI 261
PORTACOLTELLO per RIMOLDI 27 - 227 - 327 - 527 - 627
PORTACOLTELLO per RIMOLDI 29 - 229 - 329 - 529 - 629
PORTACOLTELLO per RIMOLDI 63
PORTACOLTELLO per REECE S2
PORTACOLTELLO per SINGER 136
PORTACOLTELLO per SINGER 246 - 990
PORTACOLTELLO per SINGER 451
PORTACOLTELLO per UNION 15400
PORTACOLTELLO per UNION 39200
PORTACOLTELLO per UNION 39500
PORTACOLTELLO per UNION 39800
PORTACOLTELLO per UNION 51200
PORTACOLTELLO per UNION 51400
PORTACOLTELLO per UNION 52900
PORTACOLTELLO per UNION 53100
PORTACOLTELLO per W.&G. 504 = NECCHI 604 = PEGASUS = SIRUBA = RIMOLDI 429
PORTACOLTELLO per W.&G. 515 = NECCHI 615
PORTACOLTELLO per YAMATO DCZ 341
PORTACOLTELLO per YAMATO DCZ 361
PORTACOLTELLO per YAMATO 600 / 6000 / 8000

Navette - Crochets

- Navette oscillanti - vibranti - cilindriche
- Crochets e capsule B.C.
- Crochets rotativi e capsule per Adler
- Crochets rotativi e capsule per Durkopp
- Crochets rotativi e capsule per Necchi
- Crochets rotativi e capsule per Pfaff
- Crochets rotativi e capsule per Singer
- Crochets rotativi e capsule per macchine diverse

NAVETTE OSCILLANTI - VIBRANTI - CILINDRICHE



5518



5603



5604

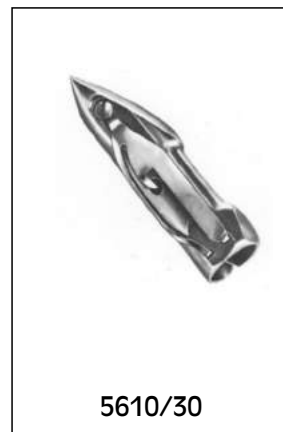

5610/30



6058



6064



6066



7001



8560



8570



8548



8550

N. di catalogo N. di descrizione	N. originale	Descrizione
5518	8654	Navetta tipo Singer 29 K 1
5603	8327	Navetta vibrante per Singer 28 K
5604	54505	Navetta vibrante per Singer 128 K
5610/30		Navetta vibrante per macchine tedesche
6058	6028	Navetta cilindrica per Singer cl. 18-2
6064	4317	Navetta cilindrica per Pfaff cl. 28-9
6066	4403	Navetta cilindrica per Pfaff cl. 28-10
7001	91046	Navetta cpl. per Singer cl. 45 K (aperta)
8560	98622	Navetta cpl. per Singer cl. 45 K (chiusa)
8570	005 00 290 4	Navetta cpl. per Adler cl. 104/105
8548	95082	Crochet separato per navetta Singer 45 K
8550	95094	Bossolo separato per navetta Singer 45 K

CROCHETS E CAPSULE B.C.

SINGER CL. 15 K 26



SINGER CL. 31 K

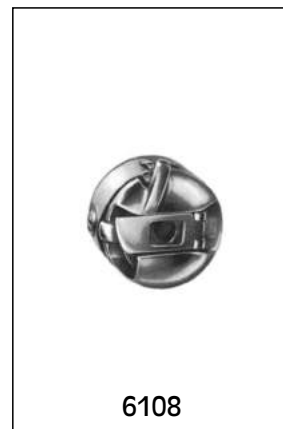

NECCHI CL. 600

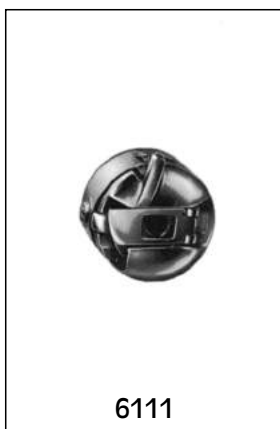

SINGER CL. 15 K 88



NECCHI CL. SUPERNOVA



SINGER CL. 71 K - 269 W



N. di catalogo N. di descrizione	N. originale	Descrizione
6100	2515	Crochet per Singer cl. 15 K 26
6102	15277	Capsula per Singer cl. 15 K 26
6105	12393	Crochet per Singer cl. 31 K
6108	62740	Capsula per Singer cl. 31 K
6110	1500	Crochet per Necchi cl. 600
6111	1505	Capsula per Necchi cl. 600
6113	125292	Crochet per Singer cl. 15 K 88
6114	125291	Capsula per Singer cl. 15 K 88
6115	26327	Crochet per Necchi cl. Supernova
6116	20176	Capsula per Necchi cl. Supernova
6117	40028	Crochet per Singer cl. 71 K-269W
6119 A	249599	Capsula per Singer cl. 71 K-269W

CROCHETS E CAPSULE B.C.

SINGER CL. 31 K 20



PFAFF CL. 30

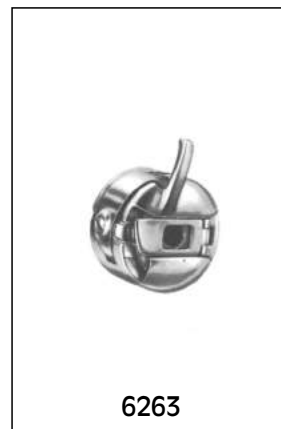

PFAFF CL. 34



PFAFF CL. 34

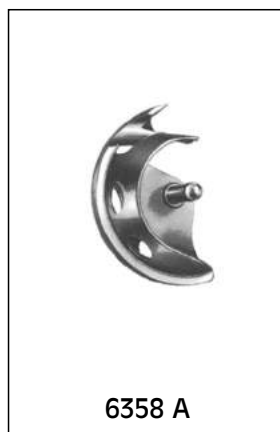

DURKOPP CL. 570



SALMOIRAGHI

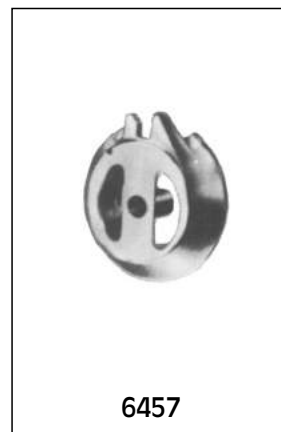



















N. di catalogo N. di descrizione	N. originale	Descrizione
6124	20757	Crochet per Singer cl. 31 K 20
6126	20756	Capsula per Singer cl. 31 K 20
6223	2131	Crochet per Pfaff cl. 30
6263	2247	Capsula per Pfaff cl. 30
6358 E	6560	Crochet per Pfaff cl. 34
6376 E	6843	Capsula per Pfaff cl. 34
6358 A	6694	Crochet per Pfaff cl. 34
6376 A	6893	Capsula per Pfaff cl. 34
6340	1242	Crochet per Durkopp cl. 570
6342	1243	Capsula per Durkopp cl. 570
6456	300/OC	Crochet per Salmoiraghi
6457	305/OC	Capsula per Salmoiraghi

CROCHETS ROTATIVI E CAPSULE PER ADLER

CL. 67/68	CL. 167	CL. 199/289	CL. 69 N. M.	CL. 69
				
8275	8250 C	8331	8340	8345
				
8277	8252	8333	8342	8347
CL. 196/296	CL. 169	CL. 167 MF	CL. 467	CL. 268 MF
				
8650	8260 C	8250 MF	8809	8810
			CL. 467 MF	
8652 = normale 8652 MF = c/frena spolina				
			8809 MF	

















N. di catalogo N. di descrizione	N. originale	Descrizione
8275	068 15138-4	Crochet per Adler cl. 67/68
8277	068 15106-4	Capsula per Adler cl. 67/68
8250 C	167181-4	Crochet cpl. per Adler cl. 167
8252	167178-4	Capsula per Adler cl. 167
8331	1991581-4	Crochet cpl. per Adler cl. 199/289
8333	52237 ZZ	Capsula per Adler cl. 199/289
8340	127239 ZZ	Crochet cpl. per Adler cl. 69 N. M.
8342 = 8632	61413E	Capsula per Adler cl. 69 N. M.
8345 = 8520	06990081-4	Crochet cpl. per Adler cl. 69
8347 = 8512	9076	Capsula per Adler cl. 69
8650	15181-4	Crochet cpl. per Adler cl. 196/296
8652	15278-4	Capsula per Adler cl. 196/296
8652 MF	15082-4	Capsula c/frena spolina per Adler cl. 196/296
8260 C	169001814	Crochet cpl. per Adler cl. 169
8809	467150014	Crochet cpl. per Adler cl. 467
8809 MF	467150094	Crochet cpl. per Adler cl. 467 rasafilo
8810	268150174	Crochet cpl. per Adler cl. 268 rasafilo
8250 MF	167150204	Crochet cpl. per Adler cl. 167 rasafilo

CROCHETS ROTATIVI E CAPSULE PER DURKOPP

CL. 249/380  8200 D  8202	CL. 551  8350  8352	CL. 211  8640  8642 = aperta 8652 C = chiusa	CL. 211 MF  8640 MF  8642 MF = aperta 8642 C = chiusa	CL. 216  8640 A  8642 A
CL. 265  8645  8647	CL. 265 MF  8645 MF  8647 MF	CL. 271  8635 MF  8637 MF	CL. 211/271  8640 MFH  8642 MFH	

N. di catalogo N. di descrizione	N. originale	Descrizione
8200 D	249592	Crochet per Durkopp cl. 249/380
8202	249628	Capsula per Dukopp cl. 249/380
8350	555901	Crochet cpl. per Dukopp cl. 551
8352	555908	Capsula per Dukopp cl. 551
8640	211261	Crochet cpl. per Dukopp cl. 211
8642	211275	Capsula aperta per Dukopp cl. 211
8642 C	211288	Capsula chiusa per Durkopp cl. 211
8640 MF	211261 MF	Crochet cpl. c/frena spolina per Dukopp cl. 211
8642 MF	2111115 MF	Capsula aperta c/frena spolina per Dukopp cl. 211
8642 C MF	2111115 MF	Capsula chiusa c/frena spolina per Dukopp cl. 211
8640 A	216161	Crochet cpl. per Durkopp cl. 216
8642 A = 8492	204335	Capsula per Durkopp cl. 216
8645 / 8645 MF	265761 / MF	Crochet cpl. per Durkopp cl. 265 / Crochet rasafilo
8647 / 8647 MF	265776 / MF	Capsula per Durkopp cl. 265 / Crochet rasafilo
8635 MF	271753	Crochet cpl. per Durkopp cl. 271
8637 MF	271771	Capsula per Durkopp cl. 271
8640 MFH		Crochet cpl. per Hirose cl. 211/271
8642 MFH		Capsula c/frena spolina per Hirose cl. 211/271

CROCHETS ROTATIVI E CAPSULE PER NECCHI

CL. 400/402	CL. RZI	CL. 835	CL. 885	CL. 750
 8720	 8730	 8740	 8740 MF	 8745
 8722	 8732	 8742	 8742 MF	 8747
CL. 720/840	CL. 902	CL. 910	CL. 955	
 8755	 8760	 8765	 8756	
 8757	 8762	 8767		





















N. di catalogo N. di descrizione	N. originale	Descrizione
8720	971963-4	Crochet cpl. per Necchi cl. 400/402
8722	8243	Capsula per Necchi cl. 400/402
8730	1105284	Crochet cpl. per Necchi cl. RZI
8732	1105280	Capsula per Necchi cl. RZI
8740	1215244	Crochet cpl. per Necchi cl. 835
8742	52340	Capsula per Necchi cl. 835
8740 MF	221525	Crochet cpl. per Necchi cl. 885
8742 MF	222528	Capsula per Necchi cl. 885
8745	153524	Crochet cpl. per Necchi cl. 750
8747=8732	1105280	Capsula per Necchi cl. 750
8755	1105244	Crochet cpl. per Necchi cl. 720/840
8757=8732	1105280	Capsula per Necchi cl. 720/840
8760	971312	Crochet cpl. per Necchi cl. 902
8762	971927-4	Capsula per Necchi cl. 902
8765	114524-4	Crochet cpl. per Necchi cl. 910
8767	971923-4	Capsula per Necchi cl. 910
8756	971989-6-00	Crochet cpl. per Necchi cl. 955, 956, 958, 965

CROCHETS ROTATIVI E CAPSULE PER PFAFF

CL. 141/142	CL. 540/541	CL. 134	CL. 133	CL. 335
				
8278	8280	8510	8515	8520C
				
8298	8282C	8512	8517	8522
CL. 234	CL. 463/480	CL. 438	CL. 3114	CL. 471
				
8600C	8690	8695	8700	8705
				
8602	8692	8697	8702	8707

N. di catalogo N. di descrizione	N. originale	Descrizione
8278	10165	Crochet cpl. per Pfaff cl. 141/142
8298	10159	Capsula per Pfaff cl. 141/142
8280	18340	Crochet cpl. per Pfaff cl. 540/541
8280C	18348	Capsula per Pfaff cl. 540/541
8510	9191	Crochet cpl. per Pfaff cl. 134
8512	9076	Capsula per Pfaff cl. 134
8515	9078	Crochet cpl. per Pfaff cl. 133
8517	9076 MF	Capsula per Pfaff cl. 133/134 - 463/480 c/Frena spolina
8520C	105490	Crochet cpl. per Pfaff cl. 335
8522=8512	9076	Capsula per Pfaff cl. 335
8600C	63090	Crochet cpl. per Pfaff cl. 234
8602=8512	9076	Capsula per Pfaff cl. 234
8690	171820	Crochet cpl. per Pfaff cl. 436/480
8692=8512	9076	Capsula per Pfaff cl. 436/480
8695	168885	Crochet cpl. per Pfaff cl. 438
8697=8512	9076	Capsula per Pfaff cl. 438
8700	8250=8154	Crochet cpl. per Pfaff cl. 3114
8702	8243	Capsula per Pfaff cl. 3114
8705	119386	Crochet cpl. per Pfaff cl. 471
8707=8298	10159	Capsula per Pfaff cl. 471

CROCHETS ROTATIVI E CAPSULE PER PFAFF

CL. 141~146	CL. 141~146	CL. 541~546	CL. 1242	CL. 1242~900
				
8278C	8278P	8280 MF	8285	8285 MF
				
8278 CA	8298	8282 MF	8282	8282 MF
CL. 293~294	CL. 3116	CL. 471~493	CL. 471~493~900	CL. 1295
				
8290	8703	8706	8715	8768
				
8292	8702	8298	8717	8770

N. di catalogo N. di descrizione	N. originale	Descrizione
8278 C	10850	Crochet cpl. per Pfaff cl. 141~146
8278 CA	11498	Capsula per Pfaff cl. 141~146
8278 P	10896	Crochet cpl. per Pfaff cl. 141~146
8298	10159	Capsula per Pfaff cl. 141~146, 191~196, 471~493, 871~893
8280 MF	18680	Crochet cpl. per Pfaff cl. 541-900~546-900 rasafilo
8282 MF	140287	Capsula per Pfaff cl. 541-900~546-900 rasafilo
8285	140538	Crochet cpl. per Pfaff cl. 1242-720, 1244-720, 1246-720
8282	18348	Capsula per Pfaff cl. 541~546, 591~596, 1241~1246
8285 MF	140540	Crochet cpl. per Pfaff cl. 1242-720-900, 1244-720-900, 1246-900 rasafilo
8282 MF	140287	Capsula per Pfaff cl. 541-900, 1241-900, 1246-900 rasafilo
8290	12781	Crochet cpl. per Pfaff cl. 293-900~294-900 rasafilo
8292	113192	Capsula per Pfaff cl. 144-900, 294-900 rasafilo
8703	120631	Crochet cpl. per Pfaff cl. 3116
8702	8243	Capsula per Pfaff cl. 3114, 3115, 3116
8706	119767	Crochet cpl. per Pfaff cl. 471~493
8298	10159	Capsula per Pfaff cl. 141~146, 191~196, 471~493, 871~893
8715	119385	Crochet cpl. per Pfaff cl. 471-900~493-900 rasafilo
8717	119458	Capsula per Pfaff cl. 471-900~493-900 rasafilo
8768	18285	Crochet cpl. per Pfaff cl. 1295-706/35 rasafilo
8770	18676	Capsula per Pfaff cl. 541-900~546-900~542-720-900 rasafilo

CROCHETS ROTATIVI E CAPSULE PER PFAFF

CL. 142-900	CL. 471~493-900	CL. 1241~1246	CL. 1241~1246	CL. 1242~1244
				
8771	8772	8773	8774	8775
				
8771 CA	8717	8282 C	8774 CA	8774 CA
CL. 1241~1246-900	CL. 133-134	CL. 463-480	CL. 471-493	CL. 471-493-900
				
8776	8510H	8690 MFH	8705 H	8715 H
				
8282 MF	8512 H	8517 H	8298 H	

N. di catalogo N. di descrizione	N. originale	Descrizione
8771	113414	Crochet cpl. per Pfaff cl. 142-900 rasafilo
8771 CA	140650	Capsula per Pfaff cl. 142-900 rasafilo
8772	119899	Crochet cpl. per Pfaff cl. 471-900~493-900 rasafilo
8717	119458	Capsula per Pfaff cl. 471-900~493-900 rasafilo
8773	140539	Crochet cpl. per Pfaff cl. 1241~1246 rasafilo
8282 C	18348	Capsula per Pfaff cl. 1241~1246
8774	140541	Crochet cpl. per Pfaff cl. 1242-720~1244-720
8774 CA	18959	Capsula per Pfaff cl. 1242-720, 1244-720
8775	140542	Crochet cpl. per Pfaff cl. 1242-720~1244-720
8774 CA	18959	Capsula per Pfaff cl. 1242-720, 1244-720
8776	140451	Crochet cpl. per Pfaff cl. 1242-900~1246-900 rasafilo
8782 MF	140287	Capsula per Pfaff cl. 1242-900~1246-900 rasafilo
8510 H	9246	Crochet cpl. Hirose per Pfaff cl. 133, 134
8512 H	9076	Capsula Hirose per Pfaff cl. 133, 134, 138, 335, 463~469, 480~489
8690 MFH	171820	Crochet cpl. Hirose per Pfaff cl. 461-900~469-900, 481-900~489-900
8517 H	9076 MF	Capsula Hirose per Pfaff cl. 138, 335, 463, 480
8705 H	119386	Crochet cpl. Hirose per Pfaff cl. 471~493
8298 H	10159	Capsula Hirose per Pfaff cl. 471~493
8715 H	119385	Crochet cpl. Hirose per Pfaff cl. 471-900~493-900 rasafilo

CROCHETS ROTATIVI E CAPSULE PER PFAFF

CL. 241-242-246























8286



8298





















N. di catalogo N. di descrizione	N. originale	Descrizione
8286	140454	Crochet cpl. per Pfaff cl. 241-242-244-245-246
8298	10159	Capsula per Pfaff cl. 241-242-244-245-246

CROCHETS ROTATIVI E CAPSULE PER SINGER

CL. 95 - Ø 5,53	CL. 96 - Ø 7,24	CL. 306 - Ø 5,53	CL. 241/251	CL. 451
 6841	 8490	 8750	 8610	 8487
 6843	 8492 8492M = magnetica	 8752 = chiusa 8752A = chiusa	 8612 8612MF = F/spolina	 8489 8489MF = F/spolina
CL. 107W 1	CL. 107W 100	CL. 457 G	CL. 95K Ant. Ø 5,53	CL. 96K Ant. Ø 7,24
 6848	 6847	 6849	 8660	 8660A
 6868	 6867	 6869	 8662	 8662













N. di catalogo N. di descrizione	N. originale	Descrizione
6841	52299	Crochet cpl. per Singer cl. 95K
6843 = 8492	52237	Capsua per Singer cl. 95K
8490	127240	Crochet cpl. per Singer cl. 96K
8492	52237	Capsua per Singer cl. 96K
8492A	52237M	Capsua magnetica per Singer cl. 96K
8750	173239	Crochet cpl. per Singer cl. 306M
8752	173058	Capsua chiusa per Singer cl. 306M
8752A	105032	Capsua aperta per Singer cl. 306M
8610	143342	Crochet cpl. per Singer cl. 241/251
8612 = 8492	52237	Capsula per Singer cl. 241/251
8612 MF	52237 MF	Capsula c/frena spolina per Singer cl. 241/251
8487	272139	Crochet cpl. per Singer cl. 451
8489 = 8492	52237	Capsula per Singer cl. 451
8489 MF	52237 MF	Capsula c/frena spolina per Singer cl. 451
6848	224447	Crochet cpl. per Singer cl. 107W 1
6868	210915	Capsula per Singer cl. 107W 1
6847	224325	Crochet cpl. per Singer cl. 107W 100
6867	224417	Capsula per Singer cl. 107W 100
6849	502718	Crochet cpl. per Singer cl. 457G
6869	502530	Capsula per Singer cl. 457G
8660	127230 JP	Crochet cpl. per Singer cl. 95 antiblocco Ø 5,53
8662 = 8492	52237	Capsula per Singer cl. 95 antiblocco
8660A	127239 JP	Crochet cpl. per Singer cl. 96 antiblocco Ø 7,24
8662 = 8492	52237	Capsula per Singer cl. 96 antiblocco

CROCHETS ROTATIVI E CAPSULE PER SINGER

CL. 108W	CL. 108W c/albero	CL. 72W	CL. 118W	CL. 119W
				
6804	8092	6834	8220	8225
				
6815	6815	6836	8222C	8222C
CL. 112W 115	CL. 112W 140	CL. 132K	CL. 212W 140	CL. 151W
				
8205	8208	8620C	8665	8680
				
8206C	8209	8622	8666C	8682

N. di catalogo N. di descrizione	N. originale	Descrizione
6804	221148	Crochet cpl. per Singer cl. 108W
6815	202796	Cestello per Singer cl. 108W
8092	224750	Crochet cpl. di albero per Singer cl. 108W
6815	202533	Cestello per Singer cl. 108W
6834	203920	Crochet cpl. per Singer cl. 72W
6836	203209	Capsula per Singer cl. 72W
8220	235797	Crochet cpl. per Singer cl. 118W
8222C	235770	Capsula per Singer cl. 118W
8225	247675	Crochet cpl. per Singer cl. 119W
8222C	235770	Capsula per Singer cl. 119W
8205	237171	Crochet cpl. per Singer cl. 112W 115
8206C	224197	Cestello per Singer cl. 112W 115
8208	248463	Crochet cpl. per Singer cl. 112W 140
8209	236692	Cestello per Singer cl. 112W 140
8620C	103123	Crochet cpl. per Singer cl. 132W
8622	103005	Capsula per Singer cl. 132W
8665	267357	Crochet cpl. per Singer cl. 212W 140
8666C	236082	Cestello per Singer cl. 212W 140
8680	224580	Crochet cpl. per Singer cl. 151W
8682	224441	Capsula per Singer cl. 151W

CROCHETS ROTATIVI E CAPSULE PER SINGER

CL. 20U	CL. 1650 Vibemac	CL. 1650 Vibemac	CL. 191 D	CL. 591 D
				
8210	8230	8230H	8235	8240A
				
8212	8232	8232H	8237	8492MF
CL. 591 D	CL. 211 G			
				
8240C	8808			
				
8742MFH				

N. di catalogo N. di descrizione	N. originale	Descrizione
8210	541674	Crochet cpl. per Singer 20U
8212	541678	Capsula per Singer 20U
8230	S00982-901	Crochet cpl. per Singer 1650 Vibemac
8232	239728	Capsula per Singer Vibemac
8230 H	S00982-901	Crochet cpl. Hirose per Singer 1650 Vibemac
8232 H	239728	Capsula Hirose per Singer Vibemac
8235	32388/545990	Crochet cpl. per Singer 191D
8237 C	143390	Capsula per Singer 191D
8240 A	544784	Crochet cpl. per Singer 591D
8492 MF	52237MF/540735	Capsula per Singer 591D
8240 C	544784	Crochet Hirose cpl. per Singer 591D
8492 MFH	52237MF	Capsula Hirose per Singer 591D
8808	510008	Crochet Hirose cpl. per Singer 211G

CROCHETS ROTATIVI E CAPSULE PER MACCHINE DIVERSE

UNION CL. 61300/61400	HUSQVARNA CL. 263	BARATTO	JUKI	RESTA
 8630	 8710	 HBA1	 8713	 8150
 8632	 8712	 HBA2	 8714 = 8492	 8152
CL. LBH-771	CL. LH4-B814	CL. LT2	CL. It2 - B845	CL. BAS 310
 8800	 8803	 8806	 8807	 8813
 8805	 8805			





N. di catalogo N. di descrizione	N. originale	Descrizione
8630	61467B	Crochet cpl. per Union Special cl. 61300/61400
8632	61413E	Capsula per Union Special cl. 61300/61400
8710	S60110	Crochet cpl. per Husqvarna cl. 263
8712 = 8492	52237	Capsula per Husqvarna cl. 263
HBA1		Crochet cpl. per Baratto
HBA2		Capsula per Baratto
8713	B1830-127-0A0	Crochet cpl. per Juki
8714 = 8492	52237	Capsula per Juki
8150	3292990111	Crochet cpl. per Resta
8152	9040135	Capsula per Resta
8800	B1808-771-0A0	Crochet cpl. Hirose per Juki cl. LBH-771
8805	107097-101	Capsula per Juki cl. LBH-771
8803	143986-001	Crochet cpl. per Brother LH4-814
8805	107097-101	Capsula per Brother LH4-814
8806	158761-901	Crochet cpl. Hirose per Brother LT2
8807	S13614-901	Crochet cpl. Hirose per Brother LT2-B845 rasafilo
8813	S15903-201	Capsula Hirose per Brother BAS-310

Navette - Crochets

- Adler
- Durkopp
- Necchi
- Pfaff
- Singer





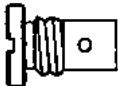



TIPO ADLER

NUMERO VITE

687/7	
S-721	
S-958	
S-978	
069002230	



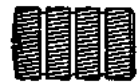





TIPO PFAFF

NUMERO VITE

73	
85	
112	
173 P	
407	
717 P	
1522	
1592	
700288	
250	





TIPO DURKOPP

NUMERO VITE





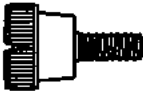









204105	
211387	
216406	
2111129	
5701252	
13006160	
216134	
216131	



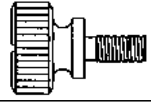
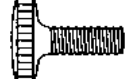

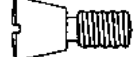







TIPO NECCHI

NUMERO VITE

20307	
121387	
746052	
1374940	
52260	
746073	

TIPO SINGER

NUMERO VITE		Diametro Filetto	Filetti per pollice
92		3/16	28
190		9/64	40
196		9/64	40
208		1/8	40
219		9/64	40
231		11/64	40
233		3/32	56
249		3/32	56
286		9/64	40
288		9/64	40
329		11/64	40
386		3/16	28
430		15/64	28
435		15/64	28
456		15/64	28

NUMERO VITE		Diametro Filetto	Filetti per pollice
591		3/32	100
592		5/64	64
662		3/32	56
691		11/64	40
725		3/32	56
857		1/8	44
930		9/64	40
1335		1/8	44
1338		1/4	40
1380		1/16	80
1528		3/16	28
1560		1/4	40